

KITCHEN SOLUTIONS

— IT'S TIME TO ELEVATE YOUR KITCHEN —



Make your kitchen to be
a space you feel good in.
Experience the ultimate in
comfort and style with Häfele.



HÄFELE FUNCTIONALITY: GETTING THE BEST FROM YOUR KITCHEN

All of our kitchen products bring an easy lifestyle to your family by creating a quality environment. With our innovative, technical perfect and stylish products Häfele aims to become a one stop service center for the definition of a perfect kitchen design.

HÄFELE WORLDWIDE:

Häfele's Headquarter is located in Nagold, Black Forest, Germany with 100 % private ownership. Häfele is the leading company in the distribution field of Furniture Fittings, Kitchen Solutions and Architectural Hardware. The Häfele Group international sales centres are characterized by a unique product range concept in the furniture fitting and architectural hardware sector, as well as individual consultancy and comprehensive logistic system. Häfele employs a workforce of around 8,000 people worldwide working in 37 countries on 5 continents.



CONTENT

Larder Unit	5
Base Unit	8
Corner Unit	16
Wall Unit	19
Waste Bin	21
Drawer Runner & Organizer	25
Flap Fittings	29
Accessories	33
Kitchen Reference	35



Larder Unit

TANDEM PANTRY



- Material : Steel
- Finish : Chrome or Anthracite
- Feature : With Anti Slip coating
- Version : Internal pull-out unit come automatically to the front, with soft closing device
- Load capacity :
- Door rack 450mm cabinet : 20kg
- Door rack 600mm cabinet : 25kg
- Pull out rack 450mm cabinet : Max. 50kg
- Pull out rack 600mm cabinet : Max. 60kg
- Internal cabinet depth : Min. 500mm
- Inside cabinet height : Min. 1700mm
- Side panel thickness : 16 - 19mm
- No. of trays : 6

Supplied with

Set components complete with runner, pull-out frame, front brackets, tray/baskets and door shelf, include damping system SoftStop.

Cabinet width mm	Finish/Color	Art. No.
450	Chrome	545.94.612
	Anthracite	545.93.431
600	Chrome	545.94.652
	Anthracite	545.93.435

Packing: 1 Set

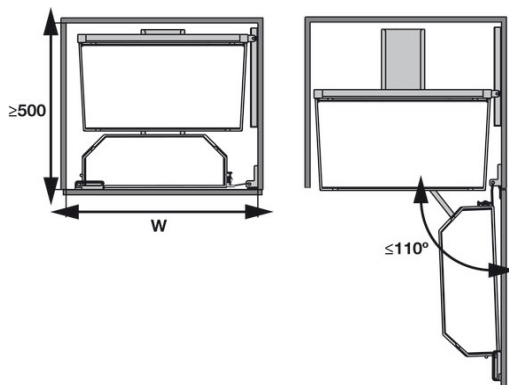

Recommended Instruction

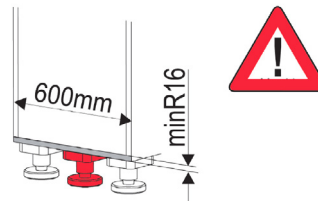

TANDEM COFFEE



- Material : Steel
- Finish : Anthracite
- Dimension of trays : 513 x 275 x 75mm
- No. of trays : 3
- Load capacity :
- Door rack : 25kg
- Pull out rack : 60kg
- Inside cabinet height : Min. 800mm

Inside cabinet height mm	Finish	Art. No.
Min. 800	Anthracite	545.93.436

Packing: 1 Set

Larder Unit

DOOR AGENT TALL UNIT



Note:
Photo contains 2 pcs Tray DoorAgent
+ 1 pc boxes Tray DoorAgent



ANTIBACTERIAL
With special antibacterial coating to keep
you and your family safe.

Material : Steel, Polypropylene
Finish : Silver, Anthracite
Min. internal cabinet width : 562mm
Min. internal cabinet height : 580mm
Min. internal cabinet depth : 180mm
Cabinet width : 600mm
Side panel thickness : 16-19mm
Load capacity : 1,5kg per box, 8kg per tray
Product dimension : 460 x 560 x 165mm

Model	Finish/ Color	Art. No.
Boxes and tray	Silver	543.22.903
	Anthracite	543.22.913
2 tray	Silver	543.22.403
	Anthracite	543.22.413

Packing: 1 Set

MILAN SERIES SWIVEL PANTRY



Material : Steel frame, basket stainless steel 304
Finish : Frame grey, basket stainless steel
polished

Load capacity
Door rack 450 mm cabinet : Max. 6kg,
Door rack 600 mm cabinet : Max. 6kg,
Pull-out rack 450 mm cabinet : Max. 30kg,
Pull-out rack 600 mm cabinet : Max. 40kg
Version : Soft closing, with 2 dampers
Internal basket position adjustable and removable front basket
Min. internal cabinet depth : 530mm

Supplied with

1 Pair runners, 1 set frame, 1 set front bracket, 12 baskets and 1 set fixing screw.

Cabinet width mm	Dim. WxDxH mm	Art. No.
450	414 x 545 x 1,820	549.91.143
600	564 x 515 x 1,820	549.91.173

Packing: 1 Set



> Cycle Test DIN EN 15338, 50,000 cycles
> Neutral Salt Spray (NSS) DIN EN ISO 9227:2006 48 hours

Larder Unit

MILAN SERIES PULL OUT PANTRY



Material : Steel frame, stainless steel 304 basket
 Finish : Frame grey, stainless steel polished
 Load capacity : 70kg
 Version : Centre mounted, full extension with soft and self closing device
 Height adjustable : 1.770 - 2.070mm
 Cabinet width : 300mm
 Basket dimension (WxDxH) : 245 X 480 X 1770-2070mm
 Basket position adjustable

Supplied with

2 pcs. runners, 1pc. frame, 1 set front brackets, 5 brackets with support, 1 set fixing screws

Inside cabinet width mm	Finish	Art. No.
300	Grey/Stainless steel	548.93.113

Packing: 1 Set

A
 > Cycle Test DIN EN 15338, 50.000 cycles
 > Neutral Salt Spray (NSS) DIN EN ISO 9227:2006 48 hours

TURNMOTION II



Material : Steel
 Finish : Anthracite
 Load capacity : 20kg/tray
 Cabinet width : 600mm
 Internal cabinet height : 430mm
 Internal cabinet width : 562 - 568mm
 Internal cabinet depth : 495mm
 Dimension of trays : 543.5 x 448 x 87.5 mm (include support arm)

Supplied with

Set components complete with 2 trays, 2 mounting strips and fixing screws

Inside cabinet width mm	Finish	Art. No.
600	Anthracite	542.14.332

Packing: 1 Set

Base Unit

DISPENSA JUNIOR III



ARENA^{plus}
Anti-slip coating



Material	: Steel
Finish	: Powder coated, Anthracite
Version	: Height adjustable, front rails and front brackets are clipped into the hanging frame at intervals
Load bearing capacity	: 40kg
For internal cabinet height	: ≥ 615 mm
For internal cabinet depth	: ≥ 480 mm
Internal cabinet width	: Cabinet width - 40mm
Cabinet width	: 300mm
Tray dimension	: 646 x 93 x 250
Installation	: For screw fixing to base panel

Supplied with

1 pull out frame, 1 set of runners with integrated soft closing mechanism, 1 set of front brackets, 1 set of installation instructions

Note

Push catch type 2 (yellow) is suitable for applications without handles.

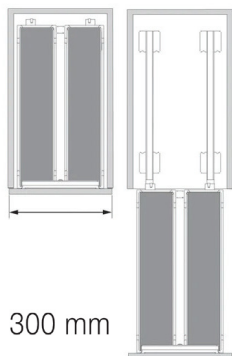

300 mm

Inside cabinet height mm	Finish	Art. No.
615	Anthracite	545.11.452

Packing: 1 Set



- > Cycle Test DIN EN 15338, 66.000 cycles
- > Neutral Salt Spray (NSS) DIN EN ISO 9227:2006 48 hours
- > Determination of resistance to humidity DIN EN ISO 6270-2; 3 cycles



Base Unit

DINING AGENT



ANTIBACTERIAL
With special antibacterial coating to keep you and your family safe.

Material	: Steel, Polypropylene
Finish	: Silver/white, Anthracite/anthracite
Min.internal cabinet width	: 562mm, 862mm
Min.internal cabinet height	: 580mm
Min.internal cabinet depth	: 480mm
Cabinet width	: 600mm, 900mm
Load capacity	: 4kg per tray, 24kg for system
Side panel thickness	: 16 -19mm
Product dimension	: 456 x 536 x 180mm, 456 x 836 x 180mm

Soft closing system

Upper

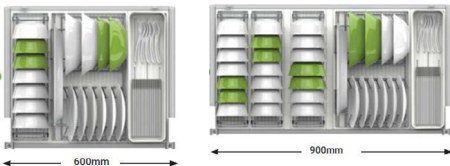

Lower

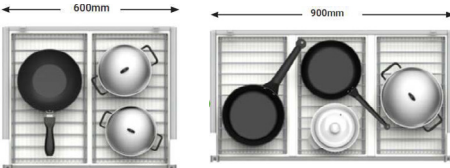

Cabinet width mm	Position	Finish/ Color	Art. No.
600	Upper	Silver/White	545.14.946
		Anthracite	545.14.446
	Lower	Silver/White	545.14.956
		Anthracite	545.14.456
900	Upper	Silver/White	545.14.949
		Anthracite	545.14.449
	Lower	Silver/White	545.14.959
		Anthracite	545.14.459

Packing: 1 Set

- > Cycle Test DIN EN 15338, 66.000 cycles
- > Neutral Salt Spray (NSS) DIN EN ISO 9227:2006 48 hours
- > Determination of resistance to humidity DIN EN ISO 6270-2; 3 cycles

COOKINGAGENT V2

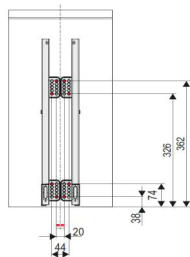

ANTIBACTERIAL
With special antibacterial coating to keep you and your family safe.

Material	: Steel, Polypropylene
Finish	: Silver/white, Anthracite/Anthracite
Min.internal cabinet width	: 262mm, 362mm
Min.internal cabinet height	: 580mm
Min.internal cabinet depth	: 500mm
Cabinet width	: 300 mm, 400mm
Load capacity	: 16kg
Side panel thickness	: 16 - 19mm
Product dimension	: 250 x 498 x 588 mm (w.300mm), 350 x 498 x 588 mm (w.400mm)

Soft closing system

- > Cycle Test DIN EN 15338, 66.000 cycles
- > Neutral Salt Spray (NSS) DIN EN ISO 9227:2006 48 hours
- > Determination of resistance to humidity DIN EN ISO 6270-2; 3 cycles

Cabinet width mm	Finish/ Color	Art. No.
300	Silver/White	545.13.803
	Anthracite	545.13.413
400	Silver/White	545.13.804
	Anthracite	545.13.404

Packing: 1 Set

Base Unit

COOKINGAGENT V3

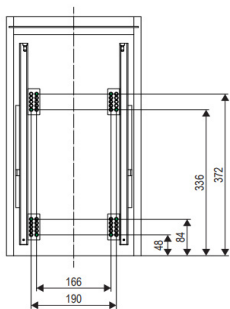

- > Cycle Test DIN EN 15338, 66.000 cycles
- > Neutral Salt Spray (NSS) DIN EN ISO 9227:2006 48 hours
- > Determination of resistance to humidity DIN EN ISO 6270-2; 3 cycles



ANTIBACTERIAL
With special antibacterial coating to keep you and your family safe.

Material	: Steel/Polypropylene
Finish	: Silver/White
Min.internal cabinet width	: ≥262mm
Min.internal cabinet height	: ≥580mm
Min.internal cabinet depth	: ≥500mm
Cabinet width	: 300mm
Load capacity	: Max. 16kg
Side panel thickness	: 16-19mm
Product dimension	: 250 x 498 x 588mm

Inside cabinet height mm	Finish	Art. No.
580	Silver/White	545.16.963
	Anthracite	545.16.463

Packing: 1 Set

MAXIAGENT

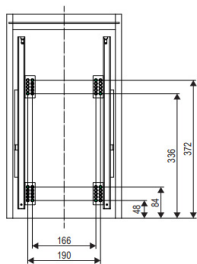

- > Cycle Test DIN EN 15338, 66.000 cycles
- > Neutral Salt Spray (NSS) DIN EN ISO 9227:2006 48 hours
- > Determination of resistance to humidity DIN EN ISO 6270-2; 3 cycles



ANTIBACTERIAL
With special antibacterial coating to keep you and your family safe.

Material	: Steel/Polypropylene
Finish	: Silver/White
Min.internal cabinet width	: ≥262mm
Min.internal cabinet height	: ≥580mm
Min.internal cabinet depth	: ≥500mm
Cabinet width	: 300mm
Load capacity	: Max. 12kg
Side panel thickness	: 16-19mm
Product dimension	: 250 x 498 x 588mm

Inside cabinet height mm	Finish	Art. No.
580	Silver/White	545.16.973
	Anthracite	545.16.473

Packing: 1 Set

Base Unit

PULL OUT 15CM



Material : Steel
 Finish : Bright chrome plated
 Version : 2-tier, Bottom mounted guide allows maximum use of storage space, for inside cabinet widths from 112mm, with soft closing device

Inside cabinet height : Min. 540mm
 Tray dimension : 465 x 104 x 37mm
 No. of tray : 2
 Load capacity : 12kg (6kg per shelf)
 Internal cabinet depth : Min. 481mm
 Side panel thickness : 16-19mm



- > Cycle Test DIN EN 15338, 66.000 cycles
- > Neutral Salt Spray (NSS) DIN EN ISO 9227:2006 48 hours
- > Determination of resistance to humidity DIN EN ISO 6270-2; 3 cycles

Inside cabinet height mm	Finish	Art. No.
540	Chrome	545.61.028
	Anthracite	549.24.620

Packing: 1 Set

URBAN AGENT



ANTIBACTERIAL
 With special antibacterial coating to keep you and your family safe.

Material : Steel, Polypropylene
 Finish : Silver/white, Anthracite/anthracite
 Min.internal cabinet width : 112mm
 Min.internal cabinet height : 540mm
 Min.internal cabinet depth : 490mm
 Cabinet width : 150mm
 Load capacity : 6kg per tray
 Side panel thickness : 16-19mm
 Product dimension : 471 x 96 x 503
 Soft closing system

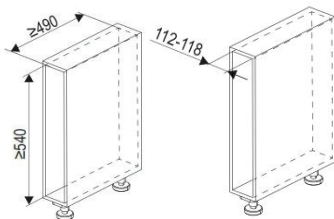

- > Cycle Test DIN EN 15338, 66.000 cycles
- > Neutral Salt Spray (NSS) DIN EN ISO 9227:2006 48 hours
- > Determination of resistance to humidity DIN EN ISO 6270-2; 3 cycles

Cabinet width mm	Finish/Color	Art. No.
150	Silver/White	545.19.799
	Anthracite	545.19.399

Packing: 1 Set

Base Unit

CLEANING AGENT PULL OUT



- > Cycle Test DIN EN 15338, 66.000 cycles
- > Neutral Salt Spray (NSS) DIN EN ISO 9227:2006 48 hours
- > Determination of resistance to humidity DIN EN ISO 6270-2; 3 cycles



ANTIBACTERIAL
With special antibacterial coating to keep you and your family safe.

- Material : Steel/Polypropylene
- Finish : Silver powder coated/white or Anthracite
- Version : Bottom base mounted, single extension with soft closing mechanism
- Load capacity : 12kg
- Internal cabinet width : Min. 298mm
- Internal cabinet depth : Min. 480mm
- Dimension (WxDxH) : 255x465x465mm

Inside cabinet width mm	Finish	Art. No.
298	White	545.48.911
	Anthracite	549.25.972

Packing: 1 Set

VERONA SERIES INTERNAL PULL-OUT UPPER BASKET



- > Cycle Test DIN EN 15338, 50.000 cycles
- > Neutral Salt Spray (NSS) DIN EN ISO 9227:2006 48 hours

- Material : Stainless steel 304
- Finish : Stainless steel polished
- Load capacity : 30kg
- Version : Runners and basket for internal pull-out behind hinged door
- Type of pull-out : Full extension with self and soft closing
- Nominal length : 450mm
- Min. internal cabinet depth : 500mm
- Side panel thickness : 16-19mm

Supplied with

1pc. basket, 1 pair runners, 1 pc. drip-off tray, 1 pc. cutlery holder, 1 pair runner covers, 1 set fixing screws.

Cabinet width mm	Basket Dim. WxDxH mm	Art. No.
600	510 x 473 x 148	549.03.254
900	810 x 473 x 148	549.03.256

Packing: 1 Set

Base Unit

VERONA SERIES INTERNAL PULL-OUT LOWER BASKET



- Material : Stainless steel 304
- Finish : Stainless steel polished
- Load capacity : 30kg
- Version : Runners and basket for internal pull-out behind hinged door
- Type of pull-out : Full extension with self and soft closing
- Min. internal cabinet depth : Min. 500mm, 450mm runners
- Side panel thickness : 16-19mm

Supplied with

1pc. basket, 1 pair runners, 1 pc. drip-off tray, 1 pc. cutlery holder, 1 pair runner covers, 1 set fixing screws.



> Cycle Test DIN EN 15338, 50.000 cycles
> Neutral Salt Spray (NSS) DIN EN ISO 9227:2006 48 hours

Cabinet width mm	Basket Dim. WxDxH mm	Art. No.
450	365 x 465 x 148	549.03.132
600	515 x 465 x 148	549.03.134
900	815 x 465 x 148	549.03.136

Packing: 1 Set

VERONA SERIES FRONT PULL-OUT UPPER BASKET



- Material : Stainless steel 304
- Finish : Stainless steel polished
- Load bearing capacity : 30kg
- Nominal length : 450mm
- Internal cabinet width : Min. 500mm
- Type of pull-out : Full extension with self and soft closing
- Side panel thickness : 16-19mm
- Version : Runners and basket for front panel fixing

Supplied with

1pc. basket, 1 pair runners, 1 pc. drip-off tray, 1 pc. cutlery holder, 1 pair runner covers, 1 set screw fixing



> Cycle Test DIN EN 15338, 50.000 cycles
> Neutral Salt Spray (NSS) DIN EN ISO 9227:2006 48 hours

Cabinet width mm	Basket Dim. WxDxH mm	Art. No.
600	537 x 465 x 195	549.03.154
900	837 x 465 x 195	549.03.156

Packing: 1 Set



Base Unit

VERONA SERIES FRONT PULL-OUT LOWER BASKET



A
 > Cycle Test DIN EN 15338, 50.000 cycles
 > Neutral Salt Spray (NSS) DIN EN ISO 9227:2006 48 hours

Material : Steel or Stainless steel 304
 Finish : Steel chrome plated, stainless steel polished
 Load bearing capacity : 30kg
 Extension type : Full extension
 Internal cabinet depth : Min. 500mm, 450 runners
 Type of pull-out : Full extension with self and soft closing
 Version : Runners and basket for front panel fixing
 Product type : Pull Out Baskets

Supplied with

1 pc. basket, 1 pair runner supports, 1 pc. 1 pair runner covers, 1 set fixing screws

Cabinet width mm	Basket Dim. WxDxH mm	Art. No.
450	387 x 465 x 148	549.03.142
500	437 x 465 x 148	549.03.143
600	537 x 465 x 148	549.03.144
900	837 x 465 x 148	549.03.146

Packing: 1 Set

PAN HANGER

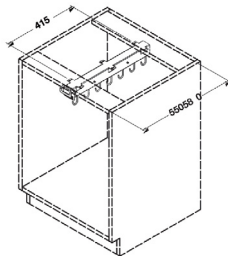

Material : Steel
 Finish : Dark grey
 Load capacity : 30kg
 Version : Ball bearing runners for screw fixing beneath top panel cabinet
 Min. internal cabinet depth : 550 - 580mm
 Number of hooks : 6 hooks
 Installation length : 415mm
 Dimension (WxDxH) : 84x521x111mm

Cabinet depth mm	Finish	Art. No.
550-580	Dark grey	549.36.500

Packing: 1 Set

Base Unit

CARRIER UP TO 30KG

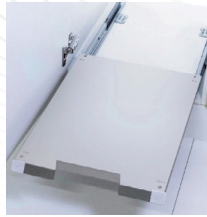

- Material : Steel base plate and runners, Polypropylene
- Finish : Base plate silver powder coated, runners zinc plated, covers grey
- Version : Soft closing, Synchronise
- Installation : Screw fixing to base panel
- Dimension :
 - Cabinet inside width : ≥ 362 mm
 - Cabinet inside height : 48 + height of the loaded (min.)
 - Cabinet inside depth : 485mm
 - Pull out travel : 444mm
 - Load capacity : 30kg
 - Dimension (WxDxH) : 330x480x48 mm

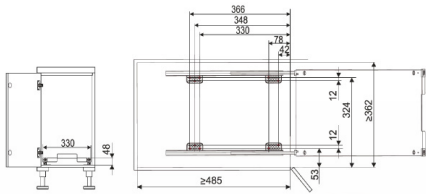

- > Load capacity up to 30kg
- > Synchronise action
- > Soft closing system
- > No more stretching and straining to lift out heavy item

Packing: 1 Set

Cabinet depth mm	Finish	Art. No.
485	Grey	505.72.990



Corner Unit

LEMANS II



- Material : Steel
- Finish : Chrome or Anthracite
- Feature : With AntiSlip coating
- Version : Trays extend completely out of the unit, each tray slides independent
- Load capacity : 25kg/tray
- Internal cabinet depth : Min. 500mm
- Side panel thickness : 16-19mm
- Inside cabinet height : 600-750mm

Supplied with

Set components complete with mounting and drilling template, incl. self-closing damping system

Right Swivel

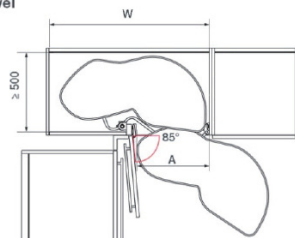

Left Swivel

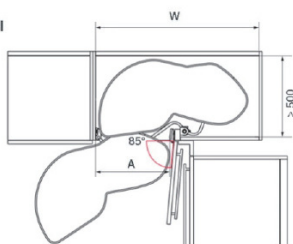

- > Cycle Test DIN EN 15338, 66.000 cycles
- > Neutral Salt Spray (NSS) DIN EN ISO 9227:2006 48 hours
- > Determination of resistance to humidity DIN EN ISO 6270-2; 3 cycles

Version: Right Swivel

Inside cabinet width mm	Finish	Art. No.
450 A= 411-418mm W Min. 800mm	Anthracite	541.29.480
	Chrome	541.32.620
500 A= 461-468mm W Min. 910mm	Anthracite	541.31.872
	Chrome	541.32.622
600 A= 561-568mm W Min. 960mm	Anthracite	541.31.878
	Chrome	541.32.624

Version: Left Swivel

Inside cabinet width mm	Finish	Art. No.
450 A= 411-418mm W Min. 800mm	Anthracite	541.29.481
	Chrome	541.32.621
500 A= 461-468mm W Min. 910mm	Anthracite	541.31.873
	Chrome	541.32.623
600 A= 561-568mm W Min. 960mm	Anthracite	541.31.879
	Chrome	541.32.625

Corner Unit

NINKA ARC POWER SLIDE

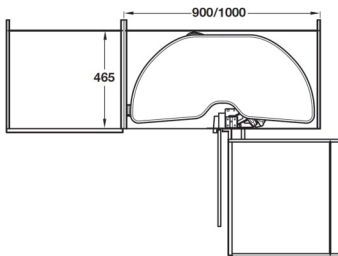

> Please note: door needs to open a min. 92° to allow the unit to pull out so suitable cabinet hinges must be used
 > Wide corner post must also be fitted, if D handles or similar protruding handles are used on the unit doors

Material : Polypropylene
 Finish : Dark grey
 Load capacity : 20kg per shelf
 Cabinet depth : Min. 490mm
 Cabinet width : 900, 1000, 1200mm
 Height : Min. 564mm

Supplied with

2 storage trays, 1 pull out and pivoting mechanism, Fixing material and tools, Fitting instructions.

Right Hand

Door width mm	Dim. WxDxH mm	Art. No.
450	900 x 490 x 564	541.55.146
500	1000 x 490 x 564	541.55.152

Packing: 1 Set

Left Hand

Door width mm	Dim. WxDxH mm	Art. No.
450	900 x 490 x 564	541.55.147
500	1000 x 490 x 564	541.55.153

Packing: 1 Set

FLORENCE - MAGIC CORNER

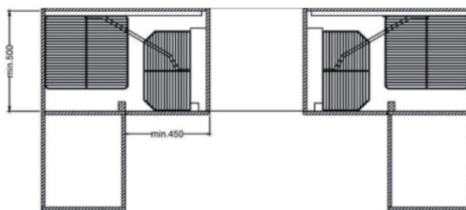

> Cycle Test DIN EN 15338, 66.000 cycles
 > Neutral Salt Spray (NSS) DIN EN ISO 9227:2006 48 hours
 > Determination of resistance to humidity DIN EN ISO 6270-2; 3 cycles

ARENA^{plus}
 Anti-slip coating



Material : Steel frame and stainless steel 304 basket
 Finish : Frame grey, basket stainless steel polished
 Load bearing capacity : Front pull out 13kg; corner pull out 17kg
 Version : Suitable for 900mm cabinet width, with soft and self closing device
 Min. internal cabinet depth : 500mm
 Min. internal cabinet height : 580mm
 Min. door width : 450mm
 Dimension (WxDxH) : 860x520x560mm

Supplied with

1 set runners with frame, 4 baskets, 1 set fixing screws

Inside cabinet height mm	Version	Art. No.
580	Right	548.21.002
	Left	548.21.012

Packing: 1 Set

Corner Unit

REVO BASKET



- Finish : Tray : Stainless steel electrolized
Spindle : Stainless steel polished
- Material : Tray & spindle: Stainless steel 304
- Version : Wire Carousel shelf, 2 layers
- Height : 635 - 850mm adjustable
- Installation : For screw & plastic klick fixing to center post
- Load bearing capacity : Max. 8kg per tray
- Inside cabinet height : 635-850mm

Supplied with

2 trays ; 1 set tube ; related fixing component

Inside cabinet height mm	Finish	Art. No.
635-850	Stainless steel	548.24.101

Packing: 1 Set

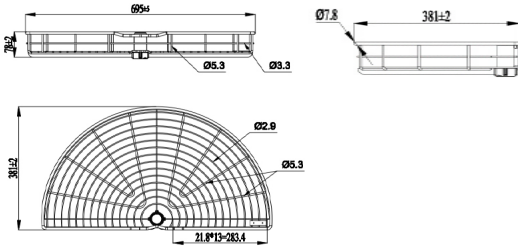

- > Cycle Test DIN EN 15338, 50.000 cycles
- > Neutral Salt Spray (NSS) DIN EN ISO 9227:2006 48 hours



Wall Unit

IMOVE PULL DOWN SYSTEM



ANTIBACTERIAL
With special antibacterial coating to keep you and your family safe.

Material : Steel
 Finish : Anthracite
 Dim. (D x H) : 267 x 380mm
 Internal cabinet depth : Min. 270mm
 Internal cabinet width :
 For cabinet width 600mm : 562 - 568mm
 For cabinet width 900mm : 862 - 868mm
 Installation : For screw fixing with chipboard screws
 Load capacity : Up to 8kg /tray
 Inside cabinet height : Min. 470mm (single)/ 710mm (double)

Supplied with

Set components complete with wooden screws 4.5 x 50mm (8 pcs) and drilling template (1 pcs)



Single Tray

Cabinet width mm	Inside cabinet height	Dim. WxDxH mm	Art. No.
600	470	565 x 267 x 380	504.68.353
900	470	865 x 267 x 380	504.68.355

Packing: 1 Set

Double Tray

Cabinet width mm	Inside cabinet height	Dim. WxDxH mm	Art. No.
600	710	565 x 267 x 380	504.68.363

Packing: 1 Set



- > Cycle Test DIN EN 15338, 66.000 cycles
- > Neutral Salt Spray (NSS) DIN EN ISO 9227:2006 48 hours
- > Determination of resistance to humidity DIN EN ISO 6270-2; 3 cycles

ORIA



Material : Steel
 Finish : Anthracite
 Feature : Anti slip mat
 Weight capacity : Total max. 10kg
 Dimension (W x D x H) mm : 860 x 280 x 560
 Internal cabinet depth (mm) : 280
 Cabinet width : 900mm

Adjustment:

- Pull out both buttons when basket is empty
- Push in left button and pull out right button: 1-5kg
- Pull out left button and push in right button: 5-7kg
- Push in both buttons: 6-12kg

Cabinet width mm	Dim. WxDxH mm	Art. No.
900	860x280x560	504.76.318

Packing: 1 Set



- > Cycle Test DIN EN 15338, 50.000 cycles
- > Neutral Salt Spray (NSS) DIN EN ISO 9227:2006 48 hours

Wall Unit

LENTO

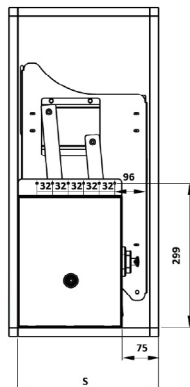
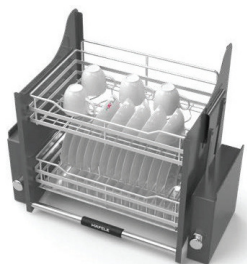

Material : Stainless Steel SUS304
 Finish : Stainless Steel SUS304
 Load bearing capacity : Max.12kg
 Dimension (W x D) mm : 600: 562 x 266 x 560
 900: 862 x 266 x 560

Design for modern kitchen
 Easy to pull up and down, to arrange and take out items
 Supplied with water drain sheet and chopstick box
 Easy to clean

Cabinet width mm	Dim. WxDxH mm	Art. No.
600	562x266x560	504.76.009
900	862x266x560	504.76.013

Packing: 1 Set



> Cycle Test DIN EN 15338, 50.000 cycles
 > Neutral Salt Spray (NSS) DIN EN ISO 9227:2006 48 hours

DISH DRAINER



Material : Stainless Steel 304 drainer grid, lateral support and draining sheet
 Polypropylene
 Finish : Grey /Stainless steel polished basket, transparent tray
 Application : Inside cabinet mounting
 Installation : For screw fixing
 Min. Internal cabinet depth : 300mm

Suitable for cabinet with the standard widths of 600mm and 900mm
 Min. internal cabinet depth
 With corrosion resistance (tested under 24 hours salt spray)

Cabinet width mm	Dim. WxDxH mm	Art. No.
600	549 x 253	544.06.024
900	849 x 253	544.06.027

Packing: 1 Set



> Neutral Salt Spray (NSS) DIN EN ISO 9227:2006 48 hours

PRESTO



Material : Stainless Steel SUS304 & Aluminium
 Finish : Tray: Stainless Steel SUS304
 Load bearing capacity : Max.10kg per tray
 Dimension (W x D) mm : 600: 564 x 276
 900: 864 x 276

Cabinet width mm	Dim. WxDxH mm	Art. No.
600	564x276	544.40.003
900	864x276	544.40.014

Packing: 1 Set



> Neutral Salt Spray (NSS) DIN EN ISO 9227:2006 48 hours

Waste Bin

ONE2FIVE WASTE BIN SYSTEM



- Separation : 2-bins and 4-bins, can organize organic and an-organic waste
- Inner bins capacity : 2x8L, 2x17L, 2x8L + 2x17L
- Type of installation : With drawer box system Hafele Matrix Box P
- Slides : Full Extension
- Material : Lids, base plates and pails plastic
- Colour : Dark grey
- Combination with Hafele Matrix Box P
- Waste separation system

Supplied with

Waste bin pail, 1 pc flexible hanging frame cover cap

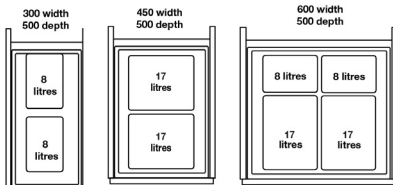

Cabinet width mm	Total capacity ltr	Waste bin pail components	To suit Matrix Box P
300	16	2 x 8 ltr	502.92.670
450	34	2 x 17 ltr	502.92.676
600	50	2 x 8 ltr & 2 x 17 ltr	502.92.688

Packing: 1 Set



- > Load capacity 35kg
- > Excellent running properties and synchronize action
- > Pass DIN EN 15338 (66,000 cycles)

TANDEM 15/15/D 300MM



- Material : Steel & Polypropylene
- Finish : Dark grey
- Separation : 2-fold
- Inner bin : 2x15 l, total capacity 30 l, 1 x Lid 15 l
- Type of installation : Bottom-mounted
- Slides : Full Extension
- Dimensions (W x D x H) : 251 x 482 x 400mm

Cabinet width min. mm	Finish	Art. No.
300	Silver/Dark grey	502.70.252

Packing: 1 Set

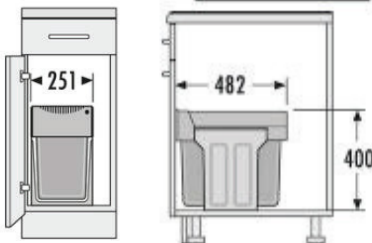

Waste Bin

SOLO 20



Manual



Automatic

Material : Steel & Polypropylene
 Finish : Slate grey
 Inner bin : 1x20 l
 Type of installation : Bottom-mounted
 Slides : Full Extension manual or Full Extension with automatic door-follower
 Colour : Dark grey
 Dimensions (W x D x H) : 245 x 427 x 396mm

Cabinet width min. mm	Version	Art. No.
300	Manual	502.43.300
400	Automatic	502.43.317

Packing: 1 Set

NINKA EASY WASTE



Material : Polypropylene
 Finish : Light grey
 Volume : 32 litres (2 x 16 litres)
 Version : For door widths from 400mm upwards
 Dimension (W x D x H) : 469x336x346mm

Cabinet width min. mm	Finish	Art. No.
400	Light grey	503.74.523

Packing: 1 Set

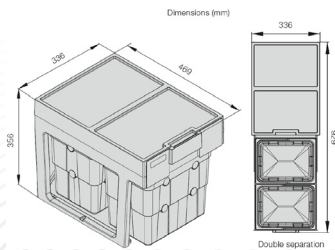

Waste Bin

MONO 12 LITRES



Material : Steel & Polypropylene
 Inner bin : 1 x 12 litres
 Type of installation : Side-wall-mounted, with door follower
 Springless turn and tilt lid
 Dimensions (W x D x H) : 293 x 298 x 298mm
 May be installed on left or on right sidewall

Cabinet width min. mm	Finish	Art. No.
400	Lid: Black Body: Stainless steel	502.12.032
	Lid: Pure white Body: Stainless steel	502.12.732

Packing: 1 Set

MONO 15 LITRES



Material : Steel & Polypropylene
 Inner bin : 1 x 15 litres
 Type of installation : Side-wall-mounted, with door follower
 Springless turn and tilt lid
 Dimensions (W x D x H) : 290 x 304 x 365mm
 May be installed on left or on right sidewall

Cabinet width min. mm	Finish	Art. No.
400	Lid: Steel white Body: Pure white	502.12.729
	Lid: Black Body: Dark grey	502.12.529
	Lid: Pure white Body: Stainless steel	502.12.023

Packing: 1 Set

UNO 19 450MM



Material : Steel & Polypropylene
 Finish : White/Light Gray
 Inner bin : 1 x 18 l
 Type of installation : Side-wall-mounted, with door follower
 Lid with turn & tilt mechanism
 Dimensions (W x D x H) : 388 x 203 x 420mm

Cabinet width min. mm	Finish	Art. No.
450	White/Light grey	502.62.710

Packing: 1 Set

Waste Bin

VIOLA



Material : Steel & Polypropylene
 Finish/Color : Dark Grey
 Mounting : For Left and Right hand use
 Capacity : 14L
 For cabinet width min. : 400,00 mm
 Dimension (WxDxH) : 227x172x170mm

Cabinet width min. mm	Finish	Art. No.
400	Dark grey	503.48.505

Packing: 1 Set

BIO BOY



Material : Polypropylene
 Finish/Color : Dark Grey
 Volume : 4.2 Litres
 Dimension (WxDxH) : 227x172x170mm
 Version : Suitable for door thickness 16-22mm

Door thickness mm	Finish	Art. No.
16-22	Dark grey	502.47.996

Packing: 1 Set

BIO BOWL



Material : Polypropylene
 Finish / colour : Bowl black / Spatula red
 Volume / load capacity : ± 2 Litres
 Version : Suitable for door thickness 15-20mm
 Dimension(W x D x H) : 295 x 170 x 120mm
 Weight : 0,8kg

Supplied with
 1 bowl + 1 spatula red

Door thickness mm	Finish	Art. No.
15-20	Black/Red	502.02.380

Packing: 1 Set

Drawer Runner & Organizer

MATRIX BOX P DRAWER SET 92MM

FULL EXTENSION, LOAD BEARING CAPACITY 35KG



Material : Steel
 Finish : Drawer sides: Powder coated,
 Cabinet runner: Galvanized
 Color : Metallic Anthracite
 Nom. Length : 500mm
 Type of pull out : Full extension, with integrated Smuso
 soft closing mechanism and self
 closing mechanism, with integrated
 rear panel fitting
 Load bearing capacity : 35kg
 Drawer side height : 92 & 115mm

Supplied with

1 left and 1 right drawer side with rear panel fitting
 1 left and 1 right cabinet runner
 1 left and 1 right cover cap with Häfele logo relief



> Synchronize runners soft and self closing mechanisms
 > Cycle Test DIN EN 15338, 50.000 cycles
 > Neutral Salt Spray (NSS) DIN EN ISO 9227:2006 48 hours

Nom. length mm	Drawer side height mm	Art. No.
500	92	513.04.305
500	115	513.14.305

Packing: 1 Set

SIDE RAILING, RECTANGULAR



For pull out for door front fixing
 Finish/ Color : Anthracite
 Nom. length : 500mm

Nom. length mm	Finish	Art. No.
500	Metallic Anthracite	551.60.325

Packing: 1 or 24 pairs

Drawer Runner & Organizer

MATRIX BOX P VIS INTERNAL DRAWER SET

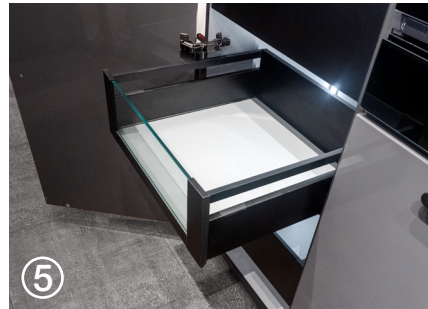
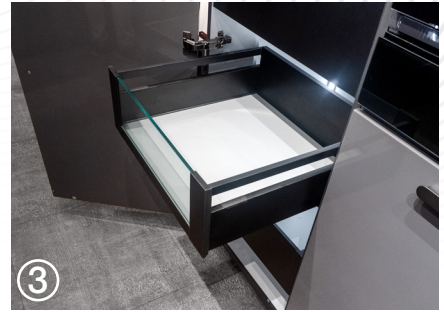
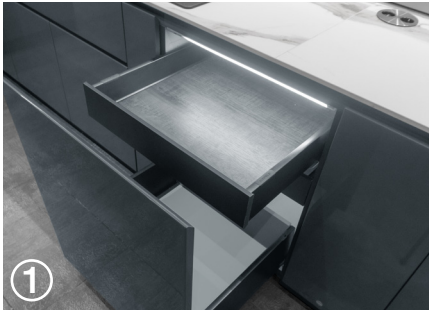

> Cycle Test DIN EN 15338, 50.000 cycles
> Neutral Salt Spray (NSS) DIN EN ISO 9227:2006 48 hours



- Type of pull out : Full extension, with integrated Smuso soft closing mechanism and self closing mechanism, with integrated rear panel fitting
- Material : Steel
Panel holder set: Polypropylene,
Panel profile: Aluminium
- Finish : Drawer sides,
Side railing and panel profile: Powder coated,
Cabinet runner: Zinc plated
- Min. Internal cabinet height : 165mm

	Front	Drawer side height mm	Cabinet width mm	Nom. Length mm	Finish	Art. No.
①	Metal	92	600	500	Metallic Anthracite	513.06.365
②	Metal	92	600	500	Metallic Anthracite	513.08.365
③	Glass	92	600	500	Metallic Anthracite	513.44.305
④	Metal	115	600	500	Metallic Anthracite	513.18.365
⑤	Glass	115	600	500	Metallic Anthracite	513.48.305

Drawer Runner & Organizer

MATRIX BOX SLIM DRAWER SET 89MM



Material : Steel
 Finish : Drawer sides: Powder coated, Cabinet runner: Zinc Plated
 Color : Anthracite
 Load bearing capacity : 30kg
 Version : Thin drawer sides of 13mm, full extension, metal drawer sides can be replaced with wooden drawer
 Nom. length : 500mm

With self closing and soft closing mechanism or with Push-to-Open

Supplied with

- 1 left and 1 right thin-walled drawer side with rear panel fitting
- 1 left and 1 right cabinet runner
- 1 left and 1 right runner coupling
- 1 left and 1 right front fixing bracket for screw fixing



Type of Pull Out	Art. No.
Full extension, with integrated soft closing and self closing mechanisms with integrated rear panel fitting	552.21.575
Full extension, with Push-to-Open with integrated rear panel fitting	552.21.565

Packing: 1 set

MATRIX BOX SLIM DRAWER SET 175MM



Material : Steel
 Finish : Drawer sides: Powder coated, Cabinet runner: Zinc Plated
 Color : Anthracite
 Load bearing capacity : 30kg
 Version : Thin drawer sides of 13mm, full extension, metal drawer sides can be replaced with wooden drawer
 Nom. length : 500mm

With self closing and soft closing mechanism or with Push-to-Open

Supplied with

- 1 left and 1 right thin-walled drawer side with rear panel fitting
- 1 left and 1 right cabinet runner
- 1 left and 1 right runner coupling
- 1 left and 1 right front fixing bracket for screw fixing
- 1 pair of L-shape connecting brackets
- 2 left and 2 right cover caps



Type of Pull Out	Art. No.
Full extension, with integrated soft closing and self closing mechanisms with integrated rear panel fitting	552.23.575
Full extension, with Push-to-Open with integrated rear panel fitting	552.23.565

Packing: 1 set

Drawer Runner & Organizer

CLASSICO UNIVERSAL



Height



> Size can be adapted trimming edges

Material : Polypropylene
 Finish : Slate grey grained
 For cabinet width : 250 - 900mm

For cabinet width mm	Art. No.
450	556.52.243
500	556.52.244
600	556.52.246
900	556.52.249

Packing: 1 Set

INSERT CLASSICO



- > Multi-purpose insert as a perfect addition to our cutlery insert series Classico
- > Perfect organisation for bigger kitchen aids
- > Lower bas as an optimal compartment division
- > Modern design compared with high functionality

Material : Polypropylene
 Surface design : Grained
 Finishing : Slate grey

Depth mm	Width mm	Drawer dim. mm	Art. No.
550	580	500/60	556.51.296
550	880	550/90	556.51.229

Packing: 1 Set

SALSA EXZELLENT



Material : Polypropylene
 Finishing : Slate grey
 Product dimension : 520 x 550mm
 Drawer dimension : 500/60mm

Drawer dim. mm	Finish	Art. No.
500/60	Slate grey	556.57.276

Packing: 1 Set

SALSA ERGOTOP



Material : Polypropylene
 Finishing : Slate grey
 Product dimension : 520 x 550mm
 Drawer dimension : 500/60
 Finishing : Slate grey
 Product width : 500 - 550mm
 depth : 440 - 520mm
 height : 47mm

Drawer dim. mm	Finish	Art. No.
500/60	Slate grey	556.51.276

Packing: 1 Set

Flap Fittings

FREE SPACE 6.15



- > Hinge-less stay flap fitting for more free room in all respects
- > Extremely powerful: A product series for the majority of the most common flap sizes and weights
- > Extremely compact: Minimal appearance and more storage space in the furniture
- > Extremely gentle running characteristics for a pleasant operating feeling
- > Extremely fast and time-saving processing
- > Extremely adaptable: Four standard colours and a product series for handle-free applications

- Area of application : For heavy stay flap applications up to 15kg (with cabinet height 600mm)
- Material : Housing: Polypropylene
Front fixing bracket and support lever: Steel
- Finish/colour : Front fixing bracket: Nickel plated,
Support lever: Nickel plated or black (with black housing),
Housing: Anthracite
- Opening angle : 90° or 107°
- Adjustment facility : Height, side, tilting angle, holding power
- Installation : Fitting for screw fixing with pre-mounted Euro screw, front panel fixing without tools, for sliding onto pre-mounted fixing screws

Supplied with

- 1 stay flap fitting set (1 fitting each left/right)
- 2 front fixing brackets with pre-mounted screws
- 1 set of installation instructions with paper drilling template for side panel

Model	Art. No.
G	372.27.321
H	372.27.322

Packing: 1 Set

FREE SPACE 1.11



- > Hinge-less stay flap fitting for more free room in all respects
- > Extremely powerful: A product series for the majority of the most common flap sizes and weights
- > Extremely compact: Minimal appearance and more storage space in the furniture
- > Extremely gentle running characteristics for a pleasant operating feeling
- > Extremely fast and time-saving processing
- > Extremely adaptable: Four standard colours and a product series for handle-free applications

- Area of application : For standard stay flap applications with front height up to 650mm
- Material : Housing: Polypropylene,
Front fixing bracket and support lever: Steel
- Finish/colour : Front fixing bracket and support lever: Nickel plated or black (with black housing),
Housing: Anthracite
- Opening angle : 90° or 107°
- Adjustment facility : Height, side, tilting angle, holding power
- Installation : Fitting for screw fixing with pre-mounted Euro screw, front panel fixing without tools, for sliding onto pre-mounted fixing screws

Supplied with

- 1 stay flap fitting set (1 piece each left/right)
- 4 fixing screws for front panel
- 1 set of installation instructions with paper drilling template for side panel

Model	Art. No.
B	372.27.350
C	372.27.351
D	372.27.352
E	372.27.353
F	372.27.354

Packing: 1 Set

Flap Fittings

Model Häfele Flap Fittings	B	C	D	E	F	G	H
Cabinet Height mm	Flap weight kg						
225	2,3 - 4,3	3,8 - 71	6,4 - 9,3	9,2 - 13,4	13,4 - 19,1		
250	1,9 - 3,9	3,4 - 6,4	5,8 - 9,1	8,3 - 12,6	12,1 - 17,2		
275	1,9 - 3,5	3,1 - 5,8	5,3 - 8,2	7,5 - 12	11 - 15,6		
300	1,7 - 3,2	2,8 - 5,3	4,8 - 7,5	6,9 - 11	10,1 - 14,3		
325	1,6 - 3,0	2,6 - 4,9	4,4 - 7,0	6,4 - 10,2	9,3 - 13,2		
350	1,5 - 2,8	2,4 - 4,6	4,1 - 6,5	5,9 - 9,5	8,6 - 12,3	11,7 - 18,9	18 - 25,7
375	1,3 - 2,6	2,2 - 4,3	3,8 - 6,0	5,5 - 8,8	8,1 - 11,4	10,9 - 17,6	16,8 - 24
400	1,2 - 2,4	2,1 - 4,0	3,6 - 5,6	5,2 - 8,3	7,6 - 10,7	10,2 - 16,5	15,8 - 22,5
425	1,1 - 2,3	2,0 - 3,8	3,4 - 5,3	4,9 - 7,8	7,1 - 10,1	9,6 - 15,5	14,8 - 21,2
450	1,0 - 2,1	1,9 - 3,5	3,2 - 5,0	4,6 - 7,3	6,7 - 9,5	9,1 - 14,7	14 - 20
475	1,0 - 2,0	1,8 - 3,4	3,0 - 4,7	4,3 - 7	6,4 - 9	8,6 - 13,9	13,3 - 18,9
500	0,9 - 1,9	1,7 - 3,2	2,9 - 4,5	4,1 - 6,6	6 - 8,6	8,2 - 13,2	12,6 - 18
525	0,9 - 1,8	1,6 - 3,0	2,7 - 4,3	3,9 - 6,3	5,7 - 8,2	7,8 - 12,6	12 - 17,1
550	0,8 - 1,7	1,5 - 2,9	2,6 - 4,1	3,7 - 6	5,5 - 7,8	7,4 - 12	11,5 - 16,4
575	0,8 - 1,7	1,4 - 2,8	2,5 - 3,9	3,6 - 5,7	5,2 - 7,4	7,1 - 11,5	11 - 15,7
600	0,8 - 1,6	1,4 - 2,7	2,4 - 3,7	3,4 - 5,5	5 - 7,1	6,8 - 11	10,5 - 15
625	0,7 - 1,5	1,3 - 2,5	2,3 - 3,6	3,3 - 5,3	4,8 - 6,8	6,5 - 10,6	10,1 - 14,4
650	0,7 - 1,5	1,3 - 2,4	2,2 - 3,5	3,2 - 5,1	4,6 - 6,6	6,3 - 10,2	9,7 - 13,8

Flap Fittings

METALLAMAT NEO 110° Ø 35mm non SC

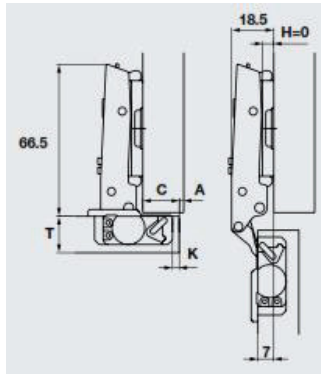
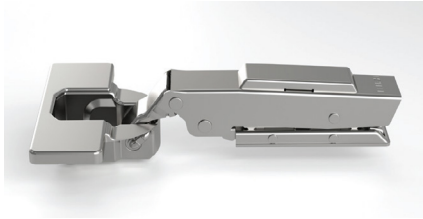

> 80,000 cycles functional cycles
> Neutral Salt Spray (NSS) DIN EN ISO 9227:2006 48 hours

Material : Steel
 Finish : Nickel plated
 Installation : Clip-on system
 Cup fixing : For screw fixing
 Drilling depth : Hinge cup 12,4mm
 Cup dimension : 45mm/9,5mm
 Adjustment facility :
 Side adjustment : ±2/-3mm
 Height adjustment : ±2/-2mm (via mounting plate)
 Depth adjustment : ±3/-2mm
 Door thickness : 16-26mm

Full Overlay Mounting	Art. No.
Non-Soft close	334.00.011

Packing: 1 pcs

Door Overlay mm										
10	11	12	13	14	15	16	17	18	19	
						3	4	5	6	0
Distance to cup K mm						Mounting plate distance mm				

CRUCIFORM MOUNTING PLATE



Material : Steel
 Finish : Nickel plated

Distance mm	Art. No.
0	334.90.021
2	334.90.027

Packing: 1 pcs

COVER CAP



Arm cover cap



Hinge cover cap

Material : Steel
 Finish : Nickel plated

Description	Art. No.
Arm Cover Cap	334.90.022
Hinge Cover Cap	334.90.023

Packing: 1 pcs

Accessories

CABINET HANGER FOR PRESS FITTING OR SCREW FIXING



- Material : Cabinet hanger: steel
- Finish : Galvanized
- Adjustment facility : Adjustment screws can be accessed from the front after installation
- Standard : The load bearing capacity of the cabinet hanger is 65kg / piece in compliance with the DIN EN 68840 standard requirements.

Cabinet hanger is mounted "invisibly" behind the rear panel (space requirements Min. 16mm)

Note
Only use hand screwdriver for adjustment.

Installation

- The cabinet hanger must be fitted in the upper third of the cabinet for safety reasons.
- With heavy loads: mount at least 2 countersunk head screws (3.5 x 30mm). Screw must rest on wall plug.

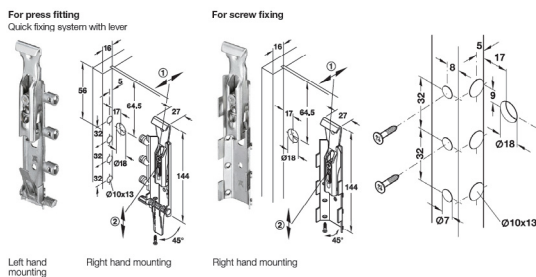

- ① depth adjustment with 20 mm clearance
- ② height adjustment 18 mm

Installation		Mounting	Art. No.
For press fitting	Quick fixing system with lever	Left	290.21.901
		Right	290.21.900
For screw fixing		Left or Right	290.21.930

Packing: 20 or 100 pcs

WALL PLATE FOR CABINET HANGER

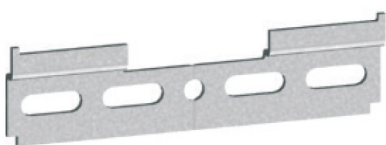

- Material : Steel
- Finish : Galvanized
- Installation : For screw fixing
- Length : 110mm

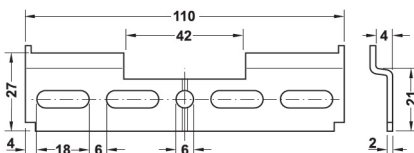

Finish	Art. No.
Galvanized	290.21.992

Packing: 1 or 50 pcs

Accessories

ADJUSTABLE FOOT FOR KITCHEN CABINET

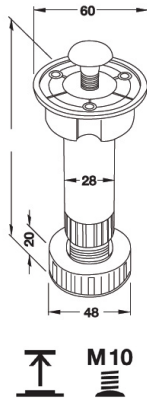

Material : Polypropylene
 Color : Black
 Adjusting range : -5 to 10mm
 Installation : With M10 fixing screw or 3 chipboard screws with countersunk head Ø3.5mm
 Load bearing capacity : Approximately 100kg

For plinth height mm	Art. No.
80	637.45.308
100	637.45.326
120	637.45.344
150	637.45.371

Packing: 1 or 200 pcs

ACCESSORIES FOR ADJUSTABLE FOOT KITCHEN CABINET

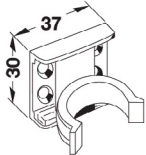

Screw Fixing

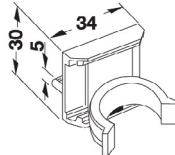

Groove mounting

Material : Polypropylene
 Color : Black

Installation	Art. No.
Screw Fixing	637.45.906
Groove Mounting	637.45.915

Packing: 1,100 or 500 pcs

KITCHEN REFERENCE





