





TAIWAN C-MART PRACTICAL TOOLS CO., LTD. / SHANGHAI C-MART TOOLS CO., LTD.

Adjustable wrench



• High carbon steel drop forged, Polished and chrome plated

ITEM NO.	SIZE	BOX(CTN/PCS)
F0001-04	100mm/4"	12/-
F0001-06	150mm/6"	6/72
F0001-08	200mm/8"	6/60
F0001-10	250mm/10"	6/48
F0001-12	300mm/12"	6/24
F0001-15	375mm/15"	1/12
F0001-18	450mm/18"	1/12
F0001-24	600mm/24"	1/6

2-in-1 adjustable wrench, rubber grip



• High carbon steel drop forged with metric marking, phosphated finish

ITEM NO.	SIZE	BOX(CTN/PCS)
F0002-06	150mm/6"	6/72
F0002-08	200mm/8"	6/60
F0002-10	250mm/10"	6/48
F0002-12	300mm/12"	6/24

Adjustable wrench



• High carbon steel drop forged, Polished and chrome plated

ITEM NO.	SIZE	BOX(CTN/PCS)
F0102-06	150mm/6"	6/72
F0102-08	200mm/8"	6/60
F0102-10	250mm/10"	6/48
F0102-12	300mm/12"	6/24

Double open-end wrench



• Chrome vanadium steel drop Forged, fine sand blast finish

ITEM NO.	SIZE	BOX(CTN/PCS)
F0003-0607	6*7mm	12/144
F0003-0810	8*10mm	12/144
F0003-1012	10*12mm	12/144
F0003-1113	11*13mm	12/144
F0003-1214	12*14mm	12/120
F0003-1315	13*15mm	12/120
F0003-1417	14*17mm	12/120
F0003-1618	16*18mm	12/120
F0003-1719	17*19mm	12/120
F0003-1921	19*21mm	6/36
F0003-1922	19*22mm	6/36
F0003-2123	21*23mm	6/36
F0003-2224	22*24mm	6/36
F0003-2326	23*26mm	6/60
F0003-2427	24*27mm	6/60
F0003-3032	30*32mm	6/60

Double box-end wrench



• Chrome vanadium steel drop Forged, fine sand blast finish

ITEM NO.	SIZE	BOX(CTN/PCS)
F0004-0607	6*7mm	12/144
F0004-0810	8*10mm	12/144
F0004-1012	10*12mm	12/144
F0004-1113	11*13mm	12/120
F0004-1214	12*14mm	12/120
F0004-1315	13*15mm	10/100
F0004-1417	14*17mm	10/100
F0004-1618	16*18mm	10/100
F0004-1719	17*19mm	10/100
F0004-1921	19*21mm	10/60
F0004-1922	19*22mm	10/60
F0004-2123	21*23mm	10/60
F0004-2224	22*24mm	10/60
F0004-2326	23*26mm	10/40
F0004-2427	24*27mm	10/40
F0004-3032	30*32mm	10/40

Combination wrench



• Chrome vanadium steel drop Forged, fine sand blast finish

ITEM NO.	SIZE	BOX(CTN/PCS)
F0005-5.5	5.5mm	12/144
F0005-06	6mm	12/144
F0005-07	7mm	12/144
F0005-08	8mm	12/144
F0005-09	9mm	12/144
F0005-10	10mm	12/144
F0005-11	11mm	12/144
F0005-12	12mm	12/144
F0005-13	13mm	12/144
F0005-14	14mm	12/144
F0005-15	15mm	10/100
F0005-16	16mm	10/100
F0005-17	17mm	6/72
F0005-18	18mm	6/36
F0005-19	19mm	6/36
F0005-20	20mm	4/24
F0005-21	21mm	4/24
F0005-22	22mm	4/24
F0005-23	23mm	6/36
F0005-24	24mm	6/36
F0005-25	25mm	6/36
F0005-26	26mm	6/36
F0005-27	27mm	6/36
F0005-28	28mm	6/36
F0005-29	29mm	6/36
F0005-30	30mm	2/40
F0005-31	31mm	2/40
F0005-32	32mm	2/40
F0005-34	34mm	5/20
F0005-36	36mm	5/20
F0005-38	38mm	5/20
F0005-41	41mm	5/10
F0005-46	46mm	5/10
F0005-50	50mm	5/10

Combination wrench CR-V



• Chrome vanadium steel drop forged, mirror polished finish

ITEM NO.	SIZE	BOX(CTN/PCS)
F0051-06	6mm	10/150
F0051-07	7mm	10/150
F0051-08	8mm	10/150
F0051-09	9mm	10/150
F0051-10	10mm	10/150
F0051-11	11mm	10/150
F0051-12	12mm	10/150
F0051-13	13mm	10/150
F0051-14	14mm	10/150
F0051-15	15mm	10/150
F0051-16	16mm	10/60
F0051-17	17mm	10/60
F0051-18	18mm	10/60
F0051-19	19mm	10/60
F0051-20	20mm	10/60
F0051-21	21mm	10/60
F0051-22	22mm	10/60
F0051-23	23mm	10/60
F0051-24	24mm	8/48
F0051-25	25mm	
F0051-26	26mm	
F0051-27	27mm	
F0051-30	30mm	
F0051-32	32mm	

Ratchet wrench-double box end

CR-V.



ITEM NO.	SIZE	BOX(CTN/PCS)
F0106-0809	8x9mm	12/144
F0106-0810	8x10mm	12/144
F0106-1011	10x11mm	12/144
F0106-1012	10x12mm	12/144
F0106-1213	12x13mm	12/144
F0106-1214	12x14mm	12/144
F0106-1415	14x15mm	12/108
F0106-1417	14x17mm	12/108
F0106-1618	16x18mm	12/72
F0106-1719	17x19mm	12/72

Double open-end wrench



• High carbon steel drop forged, mirror polished and chrome plated.

ITEM NO.	SIZE	BOX(CTN/PCS)
F0301-5.507	5.5*7mm	24/288
F0301-0607	6*7mm	24/288
F0301-0608	6*8mm	24/288
F0301-0809	8*9mm	24/288
F0301-0810	8*10mm	24/288
F0301-0911	9*11mm	24/240
F0301-1011	10*11mm	24/240
F0301-1012	10*12mm	24/240
F0301-1113	11*13mm	24/240
F0301-1213	12*13mm	24/240
F0301-1214	12*14mm	24/240
F0301-1315	13*15mm	12/168
F0301-1316	13*16mm	12/168
F0301-1415	14*15mm	12/168
F0301-1417	14*17mm	12/168
F0301-1617	16*17mm	12/168
F0301-1618	16*18mm	12/168
F0301-1719	17*19mm	12/168
F0301-1819	18*19mm	12/168
F0301-1821	18*21mm	6/120
F0301-1921	19*21mm	6/120
F0301-1922	19*22mm	6/120
F0301-2022	20*22mm	6/120
F0301-2123	21*23mm	6/72
F0301-2224	22*24mm	6/72
F0301-2326	23*26mm	6/48
F0301-2427	24*27mm	6/48
F0301-2528	25*28mm	6/48
F0301-2629	26*29mm	6/48
F0301-2730	27*30mm	6/48
F0301-3032	30*32mm	6/48

Double box-end wrench



• High carbon steel drop forged, mirror polished and chrome plated.

ITEM NO.	SIZE	BOX(CTN/PCS)
F0401-5.507	5.5*7mm	24/288
F0401-0607	6*7mm	24/288
F0401-0608	6*8mm	24/288
F0401-0809	8*9mm	24/288
F0401-0810	8*10mm	24/288
F0401-0911	9*11mm	12/240
F0401-1011	10*11mm	12/240
F0401-1012	10*12mm	12/240
F0401-1113	11*13mm	12/240
F0401-1213	12*13mm	12/240
F0401-1214	12*14mm	12/240
F0401-1315	13*15mm	12/168
F0401-1415	14*15mm	12/168
F0401-1417	14*17mm	12/168
F0401-1617	16*17mm	12/120
F0401-1618	16*18mm	12/120
F0401-1719	17*19mm	12/120
F0401-1819	18*19mm	12/120
F0401-1821	18*21mm	6/96
F0401-1921	19*21mm	6/96
F0401-1922	19*22mm	6/96
F0401-2022	20*22mm	6/96
F0401-2123	21*23mm	6/60
F0401-2224	22*24mm	6/60
F0401-2326	23*26mm	6/36
F0401-2427	24*27mm	6/36
F0401-2528	25*28mm	6/36
F0401-2629	26*29mm	6/36
F0401-2730	27*30mm	6/36
F0401-3032	30*32mm	6/36
F0401-3236	32*36mm	6/36

Impact spanner-open end



• High carbon steel drop forged, phosphated finish

ITEM NO.	SIZE	BOX(CTN/PCS)
F0055-30	30mm	1/25
F0055-32	32mm	1/25
F0055-34	34mm	1/20
F0055-36	36mm	1/20
F0055-41	41mm	1/20
F0055-46	46mm	1/20
F0055-50	50mm	1/10
F0055-55	55mm	1/10
F0055-60	60mm	1/5
F0055-65	65mm	1/5
F0055-70	70mm	1/5
F0055-75	75mm	1/5

Combination wrench



• High carbon steel drop forged, mirror polished and chrome plated.

ITEM NO.	SIZE	BOX(CTN/PCS)
F0501-5.5	5.5mm	24/288
F0501-06	6mm	24/288
F0501-07	7mm	24/288
F0501-08	8mm	24/288
F0501-09	9mm	24/288
F0501-10	10mm	24/288
F0501-11	11mm	24/288
F0501-12	12mm	12/240
F0501-13	13mm	12/240
F0501-14	14mm	12/240
F0501-15	15mm	12/168
F0501-16	16mm	12/168
F0501-17	17mm	12/168
F0501-18	18mm	12/120
F0501-19	19mm	12/120
F0501-20	20mm	12/120
F0501-21	21mm	6/96
F0501-22	22mm	6/96
F0501-23	23mm	6/60
F0501-24	24mm	6/60
F0501-25	25mm	6/60
F0501-26	26mm	6/60
F0501-27	27mm	6/36
F0501-28	28mm	6/36
F0501-29	29mm	6/36
F0501-30	30mm	6/36
F0501-31	31mm	6/36
F0501-32	32mm	6/36
F0501-1/4	1/4"	12/360
F0501-5/16	5/16"	12/360
F0501-3/8	3/8"	12/360
F0501-7/16	7/16"	12/300
F0501-1/2	1/2"	12/240
F0501-9/16	9/16"	12/240
F0501-5/8	5/8"	12/180
F0501-11/16	11/16"	12/120
F0501-3/4	3/4"	12/120
F0501-13/16	13/16"	6/90
F0501-7/8	7/8"	6/90
F0501-15/16	15/16"	6/90

Impact spanner-box end



• High carbon steel drop forged, phosphated finish

ITEM NO.	SIZE	BOX(CTN/PCS)
F0056-30	30mm	1/25
F0056-32	32mm	1/25
F0056-34	34mm	1/20
F0056-36	36mm	1/20
F0056-41	41mm	1/20
F0056-46	46mm	1/20
F0056-50	50mm	1/10
F0056-55	55mm	1/10
F0056-60	60mm	1/5
F0056-65	65mm	1/5
F0056-70	70mm	1/5
F0056-75	75mm	1/5

8-pc double open-end wrench set



• High carbon steel drop forged, mirror polished and chrome plated.

ITEM NO.	SIZE	BOX(CTN/SET)
T0003	6x7, 8x9, 10x11, 12x13, 14x15, 16x17, 18x19, 20x22mm	-/12

8-pc double box-end wrench set



• High carbon steel drop forged, mirror polished and chrome plated.

ITEM NO.	SIZE	BOX(CTN/SET)
T0004	6x7, 8x9, 10x11, 12x13, 14x15, 16x17, 18x19, 20x22mm	-/12

14-pc combination wrench set



• High carbon steel drop forged, mirror polished and chrome plated.

ITEM NO.	SIZE	BOX(CTN/SET)
T0005	8, 10, 11, 12, 13, 14, 15, 16, 17, 18, 19, 21, 22, 24mm	-/12

10-pc double open-end wrench set



• High carbon steel drop forged, mirror polished and chrome plated.

ITEM NO.	SIZE	BOX(CTN/SET)
T0003A	6x7, 8x10, 10x12, 12x14, 14x17, 17x19, 19x21, 22x24, 24x27, 30x32mm	-/12

10-pc double box-end wrench set



• High carbon steel drop forged, mirror polished and chrome plated.

ITEM NO.	SIZE	BOX(CTN/SET)
T0004A	6x7, 8x10, 10x12, 12x14, 14x17, 17x19, 19x22, 22x24, 24x27, 30x32mm	-/12

14-pc combination wrench set



• High carbon steel drop forged, mirror polished and chrome plated.

ITEM NO.	SIZE	BOX(CTN/SET)
T0006	8, 10, 11, 12, 13, 14, 15, 17, 19, 22, 24, 27, 30, 32mm	-/8

10-pc double open-end wrench set



• High carbon steel drop forged, mirror polished and chrome plated.

ITEM NO.	SIZE	BOX(CTN/SET)
T0003B	6x7, 8x9, 10x11, 12x13, 14x15, 16x17, 18x19, 20x22, 22x24, 24x27mm	-/12

10-pc double box-end wrench set



• High carbon steel drop forged, mirror polished and chrome plated.

ITEM NO.	SIZE	BOX(CTN/SET)
T0004B	6x7, 8x9, 10x11, 12x13, 14x15, 16x17, 18x19, 20x22, 22x24, 24x27mm	-/12

11-pc combination wrench set



• High carbon steel drop forged, mirror polished and chrome plated.

ITEM NO.	SIZE	BOX(CTN/SET)
T0007	8, 9, 10, 11, 12, 13, 14, 15, 17, 19, 22mm	-/12

6-pc double open-end wrench set



• High carbon steel drop forged, mirror polished and chrome plated.

ITEM NO.	SIZE	BOX(CTN/SET)
T0003C	8x10, 10x12, 12x14, 14x17, 17x19, 19x22mm	-/12

6-pc double box-end wrench set



• High carbon steel drop forged, mirror polished and chrome plated.

ITEM NO.	SIZE	BOX(CTN/SET)
T0004C	8x10, 10x12, 12x14, 14x17, 17x19, 19x22mm	-/12

9-pc combination wrench set



• High carbon steel drop forged, mirror polished and chrome plated.

ITEM NO.	SIZE	BOX(CTN/SET)
T0008	7, 8, 10, 11, 12, 13, 14, 15, 17mm	-/12

7-pc ratchet combination wrench set

FLEX HEAD

NEW!



• High carbon steel drop forged, mirror polished and chrome plated.

ITEM NO.	SIZE	BOX/CTN/SET
T0009	8, 10, 12, 13, 14, 17, 19mm	-/12

7-pc ratchet combination wrench set

NEW!



• High carbon steel drop forged, mirror polished and chrome plated.

ITEM NO.	SIZE	BOX/CTN/SET
T0010	8, 10, 12, 13, 14, 17, 19mm	-/12

Belt wrench

CR-V.



• Chrome vanadium steel drop forged

ITEM NO.	SIZE	BOX/CTN/PCS
F0007-09	225mm/9"	6/48

Chain pipe wrench

CR-V.



• Chrome vanadium steel drop forged

ITEM NO.	SIZE	BOX/CTN/PCS
F0008-09	225mm/9"	6/36

Cross rim wrench, rubber grip

Rubber grip



ITEM NO.	L	•	BOX/CTN/PCS
F0010B-400	400mm/16"	17*19*21*23mm	4/12
F0010B-500	500mm/20"	17*19*21*23mm	4/12

Quick-action cross tire wrench



ITEM NO.	•	BOX/CTN/PCS
F0010-KS	17-19-21-23mm	1/12

10-pc T type hex wrench set

CR-V.



• T-type plastic handle for better grip, chrome vanadium hex black finished

ITEM NO.	SIZE	BOX/CTN/SET
F0011	2.0, 2.5, 3.0, 4.0, 4.5, 5.0, 5.5, 6.0, 8.0, 10.0mm	-/12

1/4" dr.socket driver



ITEM NO.	SIZE	BOX/CTN/PCS
F0121	6.3mm/1/4"	12/-

Nut driver



ITEM NO.	•	BOX/CTN/PCS
F0093-05	5mm	12/120
F0093-5.5	5.5mm	12/120
F0093-06	6mm	12/120
F0093-07	7mm	12/120
F0093-08	8mm	12/120



T-type socket wrench (heavy duty)



ITEM NO.	SIZE	L	BOX(CTN/PCS)
F0091-08	8mm	305mm	10/60
F0091-09	9mm	305mm	10/60
F0091-10	10mm	305mm	10/60
F0091-11	11mm	305mm	10/60
F0091-12	12mm	305mm	10/60
F0091-13	13mm	305mm	10/60
F0091-14	14mm	305mm	10/60
F0091-15	15mm	305mm	10/60
F0091-16	16mm	305mm	10/60
F0091-17	17mm	305mm	10/60
F0091-18	18mm	305mm	12/48
F0091-19	19mm	305mm	12/48
F0091-22	22mm	305mm	12/48
F0091-24	24mm		

T-type socket wrench



ITEM NO.	SIZE	L	BOX(CTN/PCS)
F0094-08	8mm	305mm	-/50
F0094-09	9mm	305mm	-/50
F0094-10	10mm	305mm	-/50
F0094-11	11mm	305mm	-/50
F0094-12	12mm	305mm	-/50
F0094-13	13mm	305mm	-/50
F0094-14	14mm	305mm	-/50
F0094-15	15mm	305mm	-/50
F0094-16	16mm	305mm	-/50
F0094-17	17mm	305mm	-/50
F0094-18	18mm	305mm	-/50
F0094-19	19mm	305mm	-/50

Let's make a C-MART choice
C-mart tools

L-handle torx wrench

CR-V.

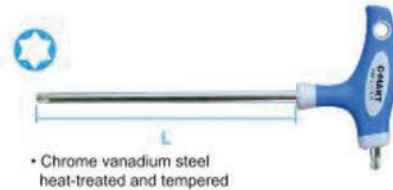

ITEM NO.	SIZE	L	BOX(CTN/PCS)
F0013-09100	T9	100mm	12/120
F0013-10100	T10	100mm	12/120
F0013-15100	T15	100mm	12/120
F0013-20100	T20	100mm	12/120
F0013-25100	T25	100mm	12/120
F0013-27150	T27	150mm	12/120
F0013-30150	T30	150mm	12/120
F0013-40150	T40	150mm	12/120
F0013-45150	T45	150mm	12/120
F0013-50150	T50	150mm	12/120

L-handle hex wrench

S2.



ITEM NO.	SIZE	L	BOX(CTN/PCS)
F0014-2.0	2.0mm	80mm	12/288
F0014-2.5	2.5mm	80mm	12/288
F0014-3.0	3.0mm	100mm	12/288
F0014-4.0	4.0mm	100mm	12/288
F0014-5.0	5.0mm	150mm	12/288
F0014-6.0	6.0mm	150mm	12/192
F0014-8.0	8.0mm	180mm	12/144
F0014-10.0	10.0mm	180mm	12/120

L-handle hex wrench-extra long

CR-V.

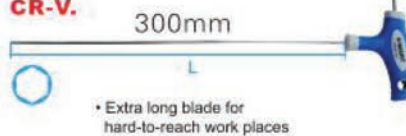

ITEM NO.	SIZE	L	BOX(CTN/PCS)
F0141-03	3mm	300mm	-/12
F0141-04	4mm	300mm	-/12
F0141-05	5mm	300mm	-/12
F0141-06	6mm	300mm	-/12
F0141-08	8mm	250mm	-/12
F0141-10	10mm	250mm	-/12

8-pc ball point hex key set

CR-V.



ITEM NO.	SIZE	BOX(CTN/SET)
F0151-MM	1.5, 2.0, 2.5, 3.0, 4.0, 5.0, 5.5, 6.0mm	6/48

9-pc ball point hex key set, long arm

CR-V.



ITEM NO.	SIZE	BOX(CTN/SET)
F0015-MM	1.5, 2.0, 2.5, 3.0, 4.0, 5.0, 6.0, 8.0, 10.0mm	6/48
F0015-INCH	1/16, 5/64, 3/32, 1/8, 5/32, 3/16, 1/4, 5/16, 3/8	6/48

9-pc ball point hex key set extra long arm

CR-V.



ITEM NO.	SIZE	BOX(CTN/SET)
F0016-MM	1.5, 2.0, 2.5, 3.0, 4.0, 5.0, 6.0, 8.0, 10.0mm	6/48
F0016-INCH	1/16, 5/64, 3/32, 1/8, 5/32, 3/16, 1/4, 5/16, 3/8	6/48

9-pc hex key set, extra long arm

CR-V.



ITEM NO.	SIZE	BOX(CTN/SET)
F0019-MM	1.5, 2.0, 2.5, 3.0, 4.0, 5.0, 6.0, 8.0, 10.0mm	6/48
F0019-INCH	1/16, 5/64, 3/32, 1/8, 5/32, 3/16, 1/4, 5/16, 3/8	6/48

9-pc ball point hex key set, long arm



ITEM NO.	SIZE	BOX(CTN/SET)
F0020-MM	1.5, 2.0, 2.5, 3.0, 4.0, 5.0, 6.0, 8.0, 10.0mm	6/48

9-pc ball point hex key set extra long arm

CR-V.



• Chrome vanadium steel, mirror finish

ITEM NO.	SIZE	BOX(CTN/SET)
F0021-MM	1.5, 2.0, 2.5, 3.0, 4.0, 5.0, 6.0, 8.0, 10.0mm	6/48

9-pc hex key set

CR-V.



• Chrome vanadium steel

ITEM NO.	SIZE	BOX(CTN/SET)
F0191-MM	1.5, 2.0, 2.5, 3.0, 4.0, 5.0, 6.0, 8.0, 10.0mm	6/48

9-pc hex key set, long arm



CR-V. • Chrome vanadium steel

ITEM NO.	SIZE	BOX(CTN/SET)
F0192-MM	1.5, 2.0, 2.5, 3.0, 4.0, 5.0, 6.0, 8.0, 10.0mm	6/48

9-pc hex key set, extra long arm



• Chrome vanadium steel

CR-V.

ITEM NO.	SIZE	BOX(CTN/SET)
F0193-MM	1.5, 2.0, 2.5, 3.0, 4.0, 5.0, 6.0, 8.0, 10.0mm	6/48

7-pc torx key set



• Chrome vanadium steel, mirror finish

CR-V.

ITEM NO.	SIZE	BOX(CTN/SET)
F0022	T9, T10, T15, T20, T25, T27, T30	10/60

Ball point hex key, extra long arm

S2



• Alloy steel heat treated and chrome plated

ITEM NO.	SIZE	BOX(CTN/PCS)
F0017-1.5	1.5mm	10/120
F0017-2.0	2.0mm	10/120
F0017-2.5	2.5mm	10/120
F0017-3.0	3.0mm	10/120
F0017-4.0	4.0mm	10/120
F0017-5.0	5.0mm	6/36
F0017-6.0	6.0mm	6/36
F0017-8.0	8.0mm	2/24
F0017-10.0	10.0mm	1/12
F0017-12.0	12.0mm	1/-
F0017-14.0	14.0mm	1/-
F0017-16.0	16.0mm	1/-
F0017-17.0	17.0mm	1/-
F0017-18.0	18.0mm	1/-
F0017-19.0	19.0mm	1/-
F0017-22.0	22.0mm	1/-
F0017-24.0	24.0mm	1/-
F0017-27.0	27.0mm	1/-
F0017-1/16	1/16"	10/120
F0017-5/64	5/64"	10/120
F0017-3/32	3/32"	10/120
F0017-7/64	7/64"	10/120
F0017-1/8	1/8"	10/120
F0017-5/32	5/32"	10/120
F0017-3/16	3/16"	6/36
F0017-7/32	7/32"	6/36
F0017-1/4	1/4"	2/24
F0017-5/16	5/16"	2/24
F0017-3/8	3/8"	1/12

9-pc torx key set



• Chrome vanadium steel, mirror finish

CR-V.

ITEM NO.	SIZE	BOX(CTN/SET)
F0023	T10, T15, T20, T25, T27, T30, T40, T45, T50	10/60

9-pc torx wrench set Extra long arm



• Chrome vanadium steel, mirror finish

CR-V.

ITEM NO.	SIZE	BOX(CTN/SET)
F0231	T10, T15, T20, T25, T27, T30, T40, T45, T50	6/36

Ball point hex key, long arm

CR-V



Both ends flat for sizes above 22mm

• Chrome vanadium steel heat treated and tempered, chrome plated

ITEM NO.	SIZE	BOX(CTN/PCS)
F0171-1.5	1.5mm	20/200/2000
F0171-2.0	2.0mm	20/200/2000
F0171-2.5	2.5mm	20/200/2000
F0171-3.0	3.0mm	12/144/1440
F0171-4.0	4.0mm	12/72/720
F0171-5.0	5.0mm	6/36/360
F0171-6.0	6.0mm	6/30/300
F0171-8.0	8.0mm	6/24/192
F0171-10.0	10.0mm	3/12/96
F0171-12.0	12.0mm	1/-
F0171-13.0	13.0mm	1/-
F0171-14.0	14.0mm	1/-
F0171-15.0	15.0mm	1/-
F0171-16.0	16.0mm	1/-
F0171-17.0	17.0mm	1/-
F0171-19.0	19.0mm	1/-
F0171-22.0	22.0mm	1/-
F0171-24.0	24.0mm	1/-
F0171-27.0	27.0mm	1/-
F0171-29.0	29.0mm	1/-
F0171-30.0	30.0mm	1/-
F0171-32.0	32.0mm	1/-
F0171-34.0	34.0mm	1/-
F0171-36.0	36.0mm	1/-

9-pc ball point hex key set, long arm

S2



• Alloy steel heat treated and red chrome plated

ITEM NO.	SIZE	BOX(CTN/SET)
F0242-MM	1.5, 2.0, 2.5, 3.0, 4.0, 5.0, 6.0, 8.0, 10.0mm	6/48

9-pc ball point hex key set extra long arm

S2



• Alloy steel heat treated and red chrome plated

ITEM NO.	SIZE	BOX(CTN/SET)
F0243-MM	1.5, 2.0, 2.5, 3.0, 4.0, 5.0, 6.0, 8.0, 10.0mm	6/48

Socket wrench, flexible handle

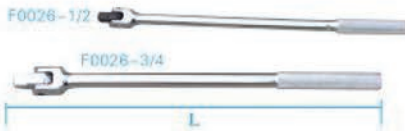

• Chrome vanadium steel, mirror finish

ITEM NO.	SIZE	L	BOX(CTN/PCS)
F0026-1/2	1/2"DR.	425mm/17"	6/24
F0026-3/4	3/4"DR.	500mm/20"	6/12

Torque wrench 1/2" DR.



ITEM NO.	SIZE	BOX(CTN/PCS)
F0025-20	20kgs / 40-210N.M.	1/10
F0025-30	30kgs / 70-350N.M.	1/8

Dial torque wrench



ITEM NO.	SIZE	BOX(CTN/PCS)
F0252	0-300Nm	1/20

Reversible ratchet handle



• Ratchet made of chrome molybdenum steel

ITEM NO.	SIZE	L	BOX(CTN/PCS)
F0027	3/4"DR.	510mm/20"	1/6
F0271	1"DR.	760mm/32"	1/-
F0027A	Ratchet head	3/4"DR.	-
F0271A	Ratchet head	1"DR.	-

Reversible ratchet handle 45T

life time free repair parts



• Ratchet made of chrome molybdenum steel

ITEM NO.	SIZE	BOX(CTN/PCS)
F0028-1/2	1/2"DR 12.5mm	6/36

Reversible ratchet handle 48T

life time free repair parts



• Ratchet made of chrome molybdenum steel



Improved ratchet mechanism for added torque

No screws needed to fasten or unfasten

Press button to quickly release socket

Ideal tool for factory, installation and automobile repair use

- 1.Improved ratchet mechanism for added torque and durability.
- 2.No screws needed to fasten or unfasten.
- 3.Switch to set clockwise and otherwise use.
- 4.Auto release button for fast socket release.
- 5.Ergo-shaped double colour plastic handle for comfort and firm grip.

ITEM NO.	SIZE	BOX(CTN/PCS)
F0281-1/2	1/2"DR 12.5mm	6/36
F0281-3/8	3/8"DR 10.0mm	10/50
F0281-1/4	1/4"DR 6.3mm	6/48

Reversible ratchet handle 72T



• Ratchet made of chrome molybdenum steel

ITEM NO.	SIZE	BOX(CTN/PCS)
F0283-1/2	1/2"DR 12.5mm	6/36
F0283-1/4	1/4"DR. 18.5mm	6/36

Telescopic ratchet handle 72T



• Ratchet made of chrome molybdenum steel

ITEM NO.	SIZE	BOX(CTN/PCS)
F0284-1/2	1/2"DR 300/440mm	6/36

Double socket ratchet wrench



• Socket made of chrome molybdenum steel, black phosphated finish

ITEM NO.	SIZE	BOX(CTN/PCS)
F0030-1012	10*12mm	2/50
F0030-1113	11*13mm	2/50
F0030-1214	12*14mm	2/50
F0030-1315	13*15mm	2/40
F0030-1317	13*17mm	2/40
F0030-1417	14*17mm	2/40
F0030-1618	16*18mm	2/40
F0030-1721	17*21mm	2/40
F0030-1719	17*19mm	2/40
F0030-1921	19*21mm	2/40
F0030-1922	19*22mm	2/40
F0030-1924	19*24mm	2/32
F0030-2123	21*23mm	2/32
F0030-2126	21*26mm	2/32
F0030-2224	22*24mm	2/32
F0030-2326	23*26mm	2/32
F0030-2427	24*27mm	2/32
F0030-3032	30*32mm	2/24
F0030-3236	32*36mm	2/24
F0030-3641	36*41mm	2/24
F0030-4146	41*46mm	2/24

Speed handle 1/2"DR.



• Chrome vanadium steel, mirror finish

ITEM NO.	L	BOX(CTN/PCS)
F0031	425mm/17"	5/20

L type handle 1/2"DR.



• Chrome vanadium steel, mirror finish

ITEM NO.	SIZE	BOX(CTN/PCS)
F0032-10	250mm/10"	10/60
F0032-12	300mm/12"	10/40

L type handle



• Chrome vanadium steel, mirror finish

ITEM NO.	SIZE	L	BOX(CTN/PCS)
F0321-18	3/4"DR.	450mm/18"	10/-
F0322-17	1"DR.	425mm/17"	12/-
F0323-06	1/4"DR.	150mm/6"	12/-

L type tire socket wrench



• Chrome vanadium steel, mirror finish

ITEM NO.	SIZE	BOX(CTN/PCS)
F0133-17	17mm	6/48
F0133-19	19mm	6/48
F0133-21	21mm	6/48
F0133-22	22mm	6/48
F0133-23	23mm	6/48
F0133-24	24mm	6/48

Sliding T handle



• Chrome vanadium steel, mirror finish

ITEM NO.	SIZE	L	BOX(CTN/PCS)
F0034-10	1/2"DR.	250mm/10"	6/54
F0341-06	3/8"DR.	160mm/6"	12/-
F0342-4.5	1/4"DR.	115mm/4.5"	12/-
F0343-20	3/4"DR.	500mm/20"	12/-
F0344-20	1"DR.	500mm/20"	12/-

Extension bar



• Chrome vanadium steel, mirror finish

ITEM NO.	SIZE	L	BOX(CTN/PCS)
F0035-05	1/2"DR.	125mm/5"	6/96
F0035-10	1/2"DR.	250mm/10"	6/54
F0351-03	3/8"DR.	75mm/3"	
F0351-06	3/8"DR.	150mm/6"	
F0351-10	3/8"DR.	250mm/10"	
F0352-02	1/4"DR.	50mm/2"	
F0352-04	1/4"DR.	100mm/4"	
F0353-08	3/4"DR.	200mm/8"	
F0354-08	1"DR.	200mm/8"	
F0354-16	1"DR.	400mm/16"	

Tire socket wrench telescopic handle

1/2"DR.



• Chrome vanadium steel, mirror finish

17mm / 19mm
21mm / 23mm

ITEM NO.	SIZE	BOX(CTN/PCS)
F0033-1/2	340/545mm	6/24

Universal joint



ITEM NO.	SIZE	BOX(CTN/PCS)
F0036	1/2"DR.	12/120
F0361	3/8"DR.	12/120
F0362	1/4"DR.	12/120

Adapter 3 way



ITEM NO.	FDR.	MDR.	SIZE	BOX(CTN/PCS)
F0037-1/2-3/8	F1/2	M3/8	12.5mm	12/-
F0037-3/8-1/2	F3/8	M1/2	10.0mm	12/-

Square adapter



ITEM NO.	FDR.	MDR.	SIZE	BOX(CTN/PCS)
F0038-1/2-3/8	F1/2	M3/8	12.5mm	12/-
F0038-3/8-1/2	F3/8	M1/2	10.0mm	12/-
F0038-3/8-1/4	F3/8	M1/4	10.0mm	12/-
F0038-1/4-3/8	F1/4	M3/8	6.30mm	12/-

Adapter



ITEM NO.	SIZE	BOX(CTN/PCS)
F0381-3/4	3/4"DR. 1"DR.	-

Bit sockets



ITEM NO.	SIZE1	SIZE2	BOX(CTN/PCS)
F0039-PH1	1/4"DR.	PH1*37mm	24/-
F0039-PH2	1/4"DR.	PH2*37mm	24/-
F0039-PH3	1/4"DR.	PH3*37mm	24/-
F0040-PH1	3/8"DR.	PH1*50mm	12/-
F0040-PH2	3/8"DR.	PH2*50mm	12/-
F0040-PH3	3/8"DR.	PH3*50mm	12/-
F0041-PH2-100	1/2"DR.	PH2*100mm	12/144
F0041-PH3-100	1/2"DR.	PH3*100mm	12/144
F0041-PH4-100	1/2"DR.	PH4*100mm	12/144

Bit sockets



ITEM NO.	SIZE1	SIZE2	BOX(CTN/PCS)
F0039-H03	1/4"DR.	H3*37mm	24/-
F0039-H04	1/4"DR.	H4*37mm	24/-
F0039-H05	1/4"DR.	H5*37mm	24/-
F0039-H06	1/4"DR.	H6*37mm	24/-
F0039-H07	1/4"DR.	H7*37mm	24/-
F0039-H08	1/4"DR.	H8*37mm	24/-
F0039-H10	1/4"DR.	H10*37mm	24/-
F0040-H03	3/8"DR.	H3*50mm	12/-
F0040-H04	3/8"DR.	H4*50mm	12/-
F0040-H05	3/8"DR.	H5*50mm	12/-
F0040-H06	3/8"DR.	H6*50mm	12/-
F0040-H07	3/8"DR.	H7*50mm	12/-
F0040-H08	3/8"DR.	H8*50mm	12/-
F0040-H10	3/8"DR.	H10*50mm	12/-
F0041-H04-100	1/2"DR.	H4*100mm	12/144
F0041-H05-100	1/2"DR.	H5*100mm	12/144
F0041-H06-100	1/2"DR.	H6*100mm	12/144
F0041-H07-100	1/2"DR.	H7*100mm	12/144
F0041-H08-100	1/2"DR.	H8*100mm	12/144
F0041-H10-100	1/2"DR.	H10*100mm	12/144
F0041-H12-100	1/2"DR.	H12*100mm	12/144
F0041-H14-100	1/2"DR.	H14*100mm	12/144
F0041-H17-100	1/2"DR.	H17*100mm	12/144
F0041-H19-100	1/2"DR.	H19*100mm	8/96
F0041-H04-55	1/2"DR.	H4*55mm	12/144
F0041-H05-55	1/2"DR.	H5*55mm	12/144
F0041-H06-55	1/2"DR.	H6*55mm	12/144
F0041-H07-55	1/2"DR.	H7*55mm	12/144
F0041-H08-55	1/2"DR.	H8*55mm	12/144
F0041-H10-55	1/2"DR.	H10*55mm	12/144
F0041-H12-55	1/2"DR.	H12*55mm	12/144
F0041-H14-55	1/2"DR.	H14*55mm	12/144
F0041-H6-250	1/2"DR.	H6*250mm	

Bit sockets



ITEM NO.	SIZE1	SIZE2	BOX(CTN/PCS)
F0041-M05-100	1/2"DR.	M5*100mm	12/144
F0041-M06-100	1/2"DR.	M6*100mm	12/144
F0041-M08-100	1/2"DR.	M8*100mm	12/144
F0041-M10-100	1/2"DR.	M10*100mm	12/144
F0041-M12-100	1/2"DR.	M12*100mm	12/144
F0041-M14-100	1/2"DR.	M14*100mm	12/144
F0041-M16-100	1/2"DR.	M16*100mm	12/144
F0041-M18-100	1/2"DR.	M18*100mm	12/144

Bit sockets



ITEM NO.	SIZE1	SIZE2	BOX(CTN/PCS)
F0039-PZ1	1/4"DR.	PZ1*37mm	24/-
F0039-PZ2	1/4"DR.	PZ2*37mm	24/-
F0039-PZ3	1/4"DR.	PZ3*37mm	24/-
F0040-PZ1	3/8"DR.	PZ1*50mm	12/-
F0040-PZ2	3/8"DR.	PZ2*50mm	12/-
F0040-PZ3	3/8"DR.	PZ3*50mm	12/-

Bit sockets



ITEM NO.	SIZE1	SIZE2	BOX(CTN/PCS)
F0039-T08	1/4"DR.	T8*37mm	24/-
F0039-T10	1/4"DR.	T10*37mm	24/-
F0039-T15	1/4"DR.	T15*37mm	24/-
F0039-T20	1/4"DR.	T20*37mm	24/-
F0039-T25	1/4"DR.	T25*37mm	24/-
F0039-T30	1/4"DR.	T30*37mm	24/-
F0039-T40	1/4"DR.	T40*37mm	24/-
F0041-T20-100	1/2"DR.	T20*100mm	12/144
F0041-T25-100	1/2"DR.	T25*100mm	12/144
F0041-T27-100	1/2"DR.	T27*100mm	12/144
F0041-T30-100	1/2"DR.	T30*100mm	12/144
F0041-T35-100	1/2"DR.	T35*100mm	12/144
F0041-T40-100	1/2"DR.	T40*100mm	12/144
F0041-T45-100	1/2"DR.	T45*100mm	12/144
F0041-T50-100	1/2"DR.	T50*100mm	12/144
F0041-T55-100	1/2"DR.	T55*100mm	12/144
F0041-T60-100	1/2"DR.	T60*100mm	12/144
F0041-T70-100	1/2"DR.	T70*100mm	12/144
F0041-T20-55	1/2"DR.	T20*55mm	12/144
F0041-T25-55	1/2"DR.	T25*55mm	12/144
F0041-T27-55	1/2"DR.	T27*55mm	12/144
F0041-T30-55	1/2"DR.	T30*55mm	12/144
F0041-T40-55	1/2"DR.	T40*55mm	12/144
F0041-T45-55	1/2"DR.	T45*55mm	12/144
F0041-T50-55	1/2"DR.	T50*55mm	12/144
F0041-T52-55	1/2"DR.	T52*55mm	12/144
F0041-T55-55	1/2"DR.	T55*55mm	12/144

Bit sockets



ITEM NO.	SIZE1	SIZE2
F0040-T08-Z	3/8"DR.	T8*50mm
F0040-T10-Z	3/8"DR.	T10*50mm
F0040-T15-Z	3/8"DR.	T15*50mm
F0040-T20-Z	3/8"DR.	T20*50mm
F0040-T25-Z	3/8"DR.	T25*50mm
F0040-T27-Z	3/8"DR.	T27*50mm
F0040-T30-Z	3/8"DR.	T30*50mm
F0040-T40-Z	3/8"DR.	T40*50mm
F0040-T45-Z	3/8"DR.	T45*50mm
F0040-T50-Z	3/8"DR.	T50*50mm
F0040-T55-Z	3/8"DR.	T55*50mm
F0040-T60-Z	3/8"DR.	T60*50mm

Bit sockets



ITEM NO.	SIZE1	SIZE2	BOX(CTN/PCS)
F0039-FD4	1/4"DR.	FD4*37mm	24/-
F0039-FD5.5	1/4"DR.	FD5.5*37mm	24/-
F0039-FD6.5	1/4"DR.	FD6.5*37mm	24/-
F0040-FD4	3/8"DR.	FD4*50mm	12/-
F0040-FD5.5	3/8"DR.	FD5.5*50mm	12/-
F0040-FD6.5	3/8"DR.	FD6.5*50mm	12/-
F0040-FD8	3/8"DR.	FD8*50mm	12/-
F0041-FD08-100	1/2"DR.	FD8*100mm	12/144
F0041-FD10-100	1/2"DR.	FD10*100mm	12/144
F0041-FD12-100	1/2"DR.	FD12*100mm	12/144

6pt reg. sockets

1/2"DR.

- Chrome vanadium steel, mirror finish



CR-V.

ITEM NO.	SIZE	BOX(CTN/PCS)
F0029-6-08	8mm	12/288
F0029-6-09	9mm	12/288
F0029-6-10	10mm	12/288
F0029-6-11	11mm	12/288
F0029-6-12	12mm	12/288
F0029-6-13	13mm	12/288
F0029-6-14	14mm	12/288
F0029-6-15	15mm	12/288
F0029-6-16	16mm	12/288
F0029-6-17	17mm	12/144
F0029-6-18	18mm	12/144
F0029-6-19	19mm	12/144
F0029-6-20	20mm	12/144
F0029-6-21	21mm	12/144
F0029-6-22	22mm	12/144
F0029-6-23	23mm	12/144
F0029-6-24	24mm	12/144
F0029-6-25	25mm	12/96
F0029-6-26	26mm	12/96
F0029-6-27	27mm	12/96
F0029-6-28	28mm	12/96
F0029-6-29	29mm	12/96
F0029-6-30	30mm	12/96
F0029-6-32	32mm	12/96
F0029-6-34	34mm	12/96
F0029-6-36	36mm	12/96

6pt deep. sockets

1/2"DR.



CR-V.

- Chrome vanadium steel, mirror finish

ITEM NO.	SIZE	BOX(CTN/PCS)
F0291-6-08	8mm	12/216
F0291-6-09	9mm	12/216
F0291-6-10	10mm	12/216
F0291-6-11	11mm	12/216
F0291-6-12	12mm	12/216
F0291-6-13	13mm	12/216
F0291-6-14	14mm	12/216
F0291-6-15	15mm	12/216
F0291-6-16	16mm	12/216
F0291-6-17	17mm	12/96
F0291-6-18	18mm	12/96
F0291-6-19	19mm	12/96
F0291-6-21	21mm	12/72
F0291-6-22	22mm	12/72
F0291-6-24	24mm	12/72
F0291-6-27	27mm	12/72
F0291-6-30	30mm	12/72
F0291-12-08	8mm	
F0291-12-10	10mm	
F0291-12-12	12mm	
F0291-12-14	14mm	
F0291-12-17	17mm	
F0291-12-19	19mm	

12pt reg. sockets

1/2"DR.



- Chrome vanadium steel, mirror finish

CR-V.

ITEM NO.	SIZE	BOX(CTN/PCS)
F0029-12-08	8mm	12/288
F0029-12-09	9mm	12/288
F0029-12-10	10mm	12/288
F0029-12-11	11mm	12/288
F0029-12-12	12mm	12/288
F0029-12-13	13mm	12/288
F0029-12-14	14mm	12/288
F0029-12-15	15mm	12/288
F0029-12-16	16mm	12/288
F0029-12-17	17mm	12/144
F0029-12-18	18mm	12/144
F0029-12-19	19mm	12/144
F0029-12-20	20mm	12/144
F0029-12-21	21mm	12/144
F0029-12-22	22mm	12/144
F0029-12-23	23mm	12/144
F0029-12-24	24mm	12/144
F0029-12-25	25mm	12/96
F0029-12-26	26mm	12/96
F0029-12-27	27mm	12/96
F0029-12-28	28mm	12/96
F0029-12-29	29mm	12/96
F0029-12-30	30mm	12/96
F0029-12-32	32mm	12/96
F0029-12-34	34mm	12/96
F0029-12-36	36mm	12/96

6pt reg. sockets

3/8"DR.

- Chrome vanadium steel, mirror finish



CR-V.

ITEM NO.	SIZE	BOX(CTN/PCS)
F0292-6-06	6mm	12/540
F0292-6-07	7mm	12/540
F0292-6-08	8mm	12/540
F0292-6-09	9mm	12/540
F0292-6-10	10mm	12/540
F0292-6-11	11mm	12/540
F0292-6-12	12mm	12/540
F0292-6-13	13mm	12/360
F0292-6-14	14mm	12/360
F0292-6-15	15mm	12/288
F0292-6-16	16mm	12/288
F0292-6-17	17mm	12/288
F0292-6-18	18mm	12/288
F0292-6-19	19mm	12/288
F0292-6-20	20mm	12/216
F0292-6-21	21mm	12/216
F0292-6-22	22mm	12/216
F0292-6-23	23mm	12/216
F0292-6-24	24mm	12/216

6pt reg. sockets with blue ribbon

1/2"DR.

Carbon steel heat treated.
Chrome plated with blue ribbon



ITEM NO.	SIZE	BOX(CTN/PCS)
F0029A-6-08	8mm	12/480
F0029A-6-09	9mm	12/480
F0029A-6-10	10mm	12/480
F0029A-6-11	11mm	12/480
F0029A-6-12	12mm	12/480
F0029A-6-13	13mm	12/480
F0029A-6-14	14mm	12/480
F0029A-6-15	15mm	12/480
F0029A-6-16	16mm	12/480
F0029A-6-17	17mm	12/144
F0029A-6-18	18mm	12/144
F0029A-6-19	19mm	12/144
F0029A-6-20	20mm	12/144
F0029A-6-21	21mm	12/144
F0029A-6-22	22mm	12/144
F0029A-6-23	23mm	12/144
F0029A-6-24	24mm	12/144
F0029A-6-25	25mm	12/96
F0029A-6-26	26mm	12/96
F0029A-6-27	27mm	12/96
F0029A-6-28	28mm	12/96
F0029A-6-29	29mm	12/96
F0029A-6-30	30mm	12/96
F0029A-6-32	32mm	12/96

6pt deep. sockets

3/8"DR.

CR-V.

• Chrome vanadium steel,
mirror finish



ITEM NO.	SIZE	BOX(CTN/PCS)
F0293-06	6mm	12/540
F0293-07	7mm	12/540
F0293-08	8mm	12/540
F0293-09	9mm	12/540
F0293-10	10mm	12/540
F0293-11	11mm	12/540
F0293-12	12mm	12/540
F0293-13	13mm	12/360
F0293-14	14mm	12/360
F0293-15	15mm	12/288
F0293-16	16mm	12/288
F0293-17	17mm	12/288
F0293-18	18mm	12/288
F0293-19	19mm	12/288
F0293-20	20mm	12/216
F0293-21	21mm	12/216
F0293-22	22mm	12/216
F0293-23	23mm	12/216
F0293-24	24mm	12/216

6pt reg. sockets

1/4"DR.

CR-V.

• Chrome vanadium steel,
mirror finish



ITEM NO.	SIZE	BOX(CTN/PCS)
F0294-6-04	4mm	24/-
F0294-6-4.5	4.5mm	24/-
F0294-6-05	5mm	24/-
F0294-6-5.5	5.5mm	24/-
F0294-6-06	6mm	24/-
F0294-6-07	7mm	24/-
F0294-6-08	8mm	24/-
F0294-6-09	9mm	24/-
F0294-6-10	10mm	12/-
F0294-6-11	11mm	12/-
F0294-6-12	12mm	12/-
F0294-6-13	13mm	12/-
F0294-6-14	14mm	12/-

12pt reg. sockets

3/4"DR.

CR-MO



ITEM NO.	SIZE	H	BOX(CTN/PCS)
F1029-12-19	19mm	50mm	-
F1029-12-21	21mm	50mm	-
F1029-12-22	22mm	51mm	-
F1029-12-23	23mm	51mm	-
F1029-12-24	24mm	51mm	-
F1029-12-26	26mm	52mm	-
F1029-12-27	27mm	52mm	-
F1029-12-28	28mm	54mm	-
F1029-12-29	29mm	54mm	-
F1029-12-30	30mm	56mm	-
F1029-12-31	31mm	56mm	-
F1029-12-32	32mm	56mm	-
F1029-12-34	34mm	56mm	-
F1029-12-36	36mm	58mm	-
F1029-12-38	38mm	60mm	-
F1029-12-41	41mm	64mm	-
F1029-12-46	46mm	68mm	-
F1029-12-48	48mm	70mm	-
F1029-12-50	50mm	72mm	-
F1029-12-55	55mm	76mm	-
F1029-12-60	60mm	78mm	-
F1029-12-65	65mm	80mm	-

6pt reg. sockets

1/4"DR.

CR-V.

• Chrome vanadium steel,
mirror finish



ITEM NO.	SIZE	BOX(CTN/PCS)
F0295-6-04	4mm	24/-
F0295-6-4.5	4.5mm	24/-
F0295-6-05	5mm	24/-
F0295-6-5.5	5.5mm	24/-
F0295-6-06	6mm	24/-
F0295-6-07	7mm	24/-
F0295-6-08	8mm	24/-
F0295-6-09	9mm	24/-
F0295-6-10	10mm	12/-
F0295-6-11	11mm	12/-
F0295-6-12	12mm	12/-
F0295-6-13	13mm	12/-
F0295-6-14	14mm	12/-

12pt reg. sockets

1"DR.

CR-MO



ITEM NO.	SIZE	H	BOX(CTN/PCS)
F2029-12-30	30mm	60mm	-
F2029-12-31	31mm	60mm	-
F2029-12-32	32mm	60mm	-
F2029-12-34	34mm	60mm	-
F2029-12-36	36mm	60mm	-
F2029-12-38	38mm	60mm	-
F2029-12-41	41mm	60mm	-
F2029-12-46	46mm	70mm	-
F2029-12-48	48mm	70mm	-
F2029-12-50	50mm	70mm	-
F2029-12-55	55mm	87mm	-
F2029-12-60	60mm	91mm	-
F2029-12-65	65mm	95mm	-
F2029-12-70	70mm	100mm	-
F2029-12-75	75mm	105mm	-
F2029-12-80	80mm	105mm	-

Spark plug socket

1/2"DR.

• Chrome vanadium steel,
mirror finish



ITEM NO.	SIZE	BOX(CTN/PCS)
F0297-16	16mm	10/60
F0297-21	21mm	10/60

Flex spark plug socket



ITEM NO.	SIZE	BOX(CTN/PCS)
F0298-16	16mm	12/216
F0298-21	21mm	12/96

Spark plug socket 1/2"DR.



- Chrome vanadium steel, mirror finish

ITEM NO.	SIZE	BOX(CTN/PCS)
F0296-16	16mm	12/216
F0296-21	21mm	12/96

Impact reg. sockets 1/2"DR.



- Made of chrome molybdenum steel, black phosphated finish

ITEM NO.	SIZE	BOX(CTN/PCS)
F0042-10	10mm	12/-
F0042-11	11mm	12/-
F0042-12	12mm	12/-
F0042-13	13mm	12/-
F0042-14	14mm	12/-
F0042-15	15mm	12/-
F0042-16	16mm	12/-
F0042-17	17mm	12/-
F0042-18	18mm	12/-
F0042-19	19mm	12/-
F0042-21	21mm	12/-
F0042-22	22mm	12/-
F0042-23	23mm	12/-
F0042-24	24mm	12/-
F0042-27	27mm	12/-
F0042-29	29mm	12/-
F0042-30	30mm	12/-
F0042-32	32mm	12/-

風動接杆 1/2"DR.

Impact extension bar



- 鉻鈦鋼,發黑處理

編號	規格	盒箱(支)
F0045-03	75mm/3'	12/-
F0045-05	125mm/5'	12/-
F0045-10	250mm/10'	12/-

Impact deep. sockets 1/2"DR.



- Made of chrome molybdenum steel, black phosphated finish

ITEM NO.	SIZE	BOX(CTN/PCS)
F0421-10	10mm	12/-
F0421-11	11mm	12/-
F0421-12	12mm	12/-
F0421-13	13mm	12/-
F0421-14	14mm	12/-
F0421-15	15mm	12/-
F0421-16	16mm	12/-
F0421-17	17mm	12/-
F0421-18	18mm	12/-
F0421-19	19mm	12/-
F0421-21	21mm	12/-
F0421-22	22mm	12/-
F0421-23	23mm	12/-
F0421-24	24mm	12/-
F0421-26	26mm	12/-
F0421-27	27mm	12/-
F0421-29	29mm	12/-
F0421-30	30mm	12/-
F0421-32	32mm	12/-

Impact sockets 3/4"DR.



- Made of chrome molybdenum steel, black phosphated finish

ITEM NO.	SIZE	BOX(CTN/PCS)
F0046-17	17mm	-
F0046-19	19mm	-
F0046-20	20mm	-
F0046-21	21mm	-
F0046-22	22mm	-
F0046-23	23mm	-
F0046-24	24mm	-
F0046-26	26mm	-
F0046-27	27mm	-
F0046-28	28mm	-
F0046-29	29mm	-
F0046-30	30mm	-
F0046-31	31mm	-
F0046-32	32mm	-
F0046-33	33mm	-
F0046-34	34mm	-
F0046-36	36mm	-
F0046-38	38mm	-
F0046-41	41mm	-
F0046-46	46mm	-
F0046-48	48mm	-
F0046-50	50mm	-
F0046-55	55mm	-

Impact sockets 1"DR.



- Made of chrome molybdenum steel, black phosphated finish

ITEM NO.	SIZE	BOX(CTN/PCS)
F0047-17	17mm	-
F0047-19	19mm	-
F0047-20	20mm	-
F0047-21	21mm	-
F0047-22	22mm	-
F0047-23	23mm	-
F0047-24	24mm	-
F0047-26	26mm	-
F0047-27	27mm	-
F0047-28	28mm	-
F0047-29	29mm	-
F0047-30	30mm	-
F0047-31	31mm	-
F0047-32	32mm	-
F0047-34	34mm	-
F0047-36	36mm	-
F0047-41	41mm	-
F0047-46	46mm	-
F0047-48	48mm	-
F0047-50	50mm	-
F0047-55	55mm	-
F0047-56	56mm	-
F0047-58	58mm	-
F0047-60	60mm	-
F0047-63	63mm	-
F0047-65	65mm	-
F0047-70	70mm	-
F0047-75	75mm	-
F0047-80	80mm	-

Impact bit sockets 1/2"DR.



- Made of chrome molybdenum steel, black phosphated finish

ITEM NO.	SIZE	BOX(CTN/PCS)
F0049-H04	H04	12/-
F0049-H05	H05	12/-
F0049-H06	H06	12/-
F0049-H08	H08	12/-
F0049-H10	H10	12/-
F0049-H12	H12	12/-
F0049-H14	H14	12/-
F0049-H17	H17	12/-
F0049-H19	H19	12/-

Magnetic nut setters



- Made of chrome molybdenum steel, black phosphated finish

ITEM NO.	SIZE	BOX(CTN/PCS)
F0043-0842	8mm(5/16")xL42	-
F0043-0865	8mm(5/16")xL65	-

Oil filter wrench



- Heavy duty drop-forged slip joint wrench with double dipped comfort grip handle.
- Fits 2-1/2"-3-1/2"(63.5-89mm)filters.

ITEM NO.	SIZE	BOX(CTN/PCS)
S0001-11	280mm/11"	6/48

Swivel handle oil filter wrench



- 90 degree swivel to access filters in confined areas.
- Black wide band resists corrosion and prevent the filter from being crushed.
- Optimum transmission of force due to ergonomically designed handgrips.

ITEM NO.	SIZE	BOX(CTN/PCS)
S0002-6073	2-3/8" - 2-7/8"	6/48
S0002-7385	2-7/8" - 3-3/8"	6/48

Oil filter wrench



ITEM NO.	SIZE	BOX(CTN/PCS)
S0021-5575	55-75mm	6/60
S0021-7595	75-95mm	6/60

Piston ring compressor



- Self locking ratchet pawl prevents premature release and allows positive locking action.

ITEM NO.	SIZE	APPLICABLE DIA.	BOX(CTN/PCS)
S0003-03	3"	53-175mm	1/50
S0003-04	4"	60-175mm	1/50
S0003-06	6"	60-195mm	1/50

3-prong oil filter wrench



- 21MM MALE HEXAGON
- FITS 2-3/4" TO 4-1/2"(70MM-110MM)

ITEM NO.	BOX(CTN/PCS)
S0004	1/40

3-prong oil filter wrench



- 21MM MALE HEXAGON
- FITS 2-3/4" TO 4-1/2"(70MM-110MM)

ITEM NO.	BOX(CTN/PCS)
S0005	1/40

Trim pad remover



編號	規格	盒箱 (支)
S0008-08	200mm/8"	

Automobile circuit tester



編號	盒箱 (支)
S0011	12/300

Inflator and gauge kit



- Aluminum handle with gauge and hose.
- 3-in-1 function: inflating, deflating and measurement of tire air pressure.

ITEM NO.	BOX(CTN/PCS)
S0015	10/40

Digital display air inflator



- ※ Nozzle length: 80mm
- ※ Maximum pressure: $\leq 0.8\text{Mpa}$
- ※ Applicable pressure: $\leq 0.2-0.4\text{Mpa}$
- ※ For tires, balls, inflatable toys and rubber boats
- ※ Valve core adjustment pin stored in handle

ITEM NO.	BOX(CTN/PCS)
S0015S	6/36

Ball joint separator



- Chrome vanadium steel drop forged
- For removal of ball joints
- Fork width:17mm

ITEM NO.	SIZE	BOX(CTN/PCS)
S0019-17	17mm	-
S0019-20	20mm	-

Ball joint separator



- Two-stage operating design suits most ball joints in steering and suspension.
- Offset lever provides maximum jaw opening at 30mm & 56mm.
- Fork width:22mm.

ITEM NO.	SIZE	BOX(CTN/PCS)
S0020		-

Coil spring clamp



- Jaws made of chrome vanadium steel.
- Poles made of carbon steel heat treated.
- Used to clamp coil springs under wheel cover.

ITEM NO.	SIZE	BOX(CTN/PCS)
S0022-270	270mm	-
S0022-370	370mm	-

Bearing separator set

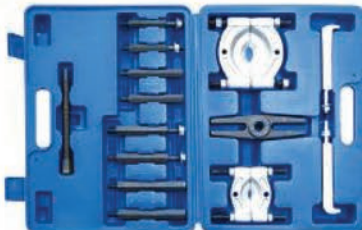

- Bearing separator & bolts 1 set (415 drop forged hardened 42°~45°capacity 30mm~50mm).
- Bearing separator & bolts 1 set (415 drop forged hardened 42°~45°capacity 50mm~75mm).
- Main rod 4 pieces (hex bar 17mm 3/8"x127mmx16t).
- Extension rod 4 pieces (hex bar 14mm 3/8"x102mmx16t).
- Beam 1 piece (carbon steel).
- Center bolt 1 piece(9/16x1175x10t/inch carbon steel).

編號	規格	盒箱 (支)
S0017	30-75mm	1/4

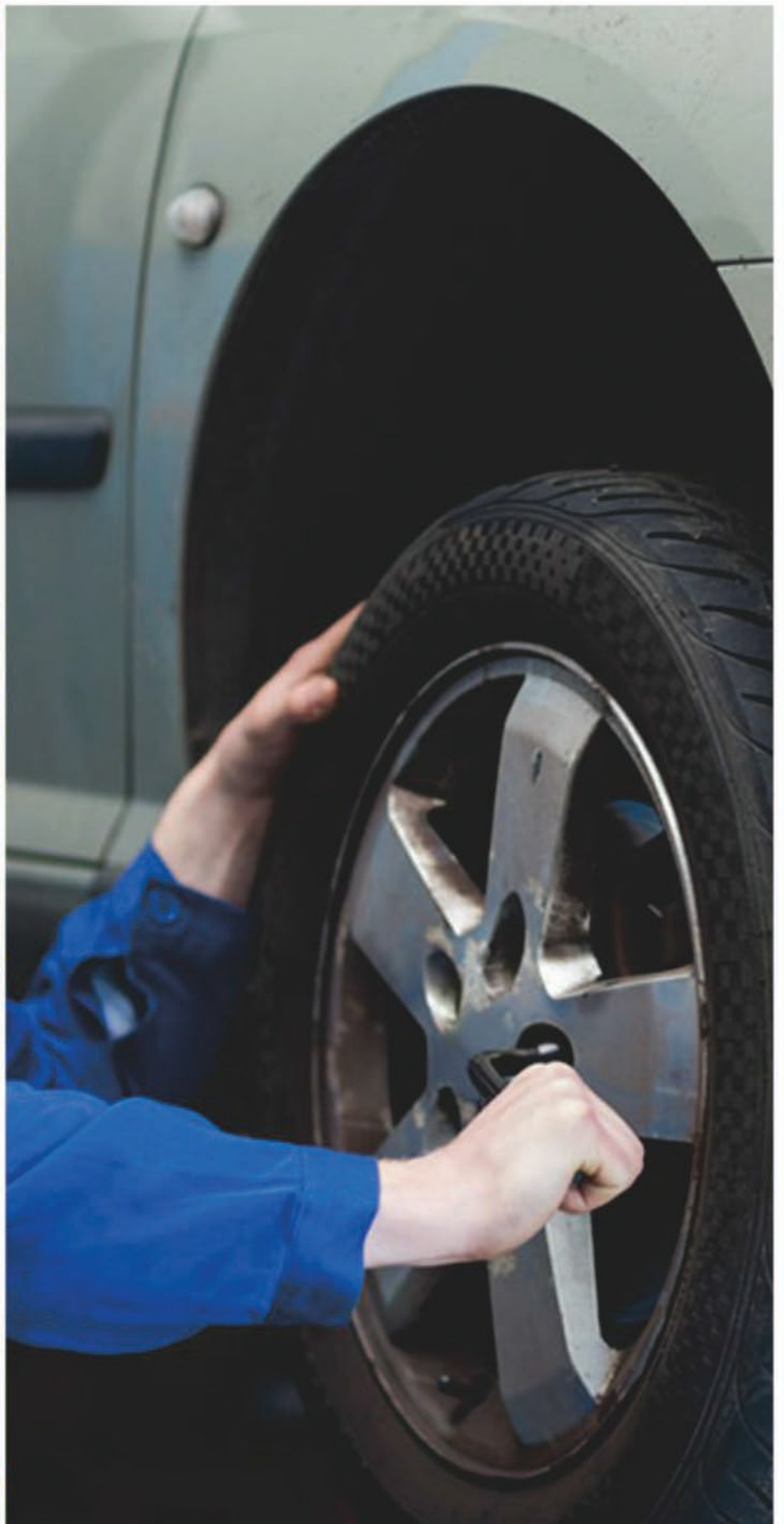



TAIWAN C-MART PRACTICAL TOOLS CO., LTD. / SHANGHAI C-MART TOOLS CO., LTD.

8-pc tool kit

- Screwdriver
 ⚡ 5×100 ⚡ 5×100
- Utility cutter
- Measuring tape
 2m×13mm
- Adjustable wrench
 200mm/8"
- Lineman's pliers
 175mm/7"
- Voltage tester
- Canvas bag



ITEM NO.	SIZE	BOX(CTN/SET)
K0001	8-pc set	1/16

42-pc electrician's tool kit



- Claw hammer 8 oz
- Lineman's pliers 175mm/7"
- Point-nosed pliers
 150mm/6"
- 6-pc screwdriver set
- Soldering iron 30w
- Multi-function scissors
 175mm/7"
- Electrician's knife
- Adjustable wrench
 200mm/8"
- Crimping pliers
- Measuring tape
 3m×16mm
- Digital voltage tester
- 9pc 6.3mm socket:
 4, 5, 6, 7, 8, 9, 10, 11, 12, 13mm
- 8pc ball point hex key set long arm
- Spinner handle
- 8 pcs of screwdrivers
 ⚡ 6×150mm
 ⚡ 5×100mm
 ⚡ 3.2×150mm
 ⚡ 3.2×75mm
 ⚡ 6×150mm
 ⚡ 5×100mm
 ⚡ 3.2×150mm
 ⚡ 3.2×75mm

ITEM NO.	SIZE	BOX(CTN/SET)
K0004	42-pc set	1/6

18-pc tool kit

- Voltage tester
- Screwdriver
 ⚡ 6×100 ⚡ 6×100
- Scissors
- Insulating tape
- Flashlight
- Adjustable wrench
 200mm/8"
- Claw hammer 8 oz
- Lineman's pliers
 175mm/7"
- Point-nosed pliers
 150mm/6"
- Measuring tape
 2m×13mm
- 6-pc precision screwdriver set
- Canvas bag



ITEM NO.	SIZE	BOX(CTN/SET)
K0002	18-pc set	1/8

59-pc electrician's tool kit



- Screwdrivers
 ⚡ 5×100 ⚡ 5×100
- Machinist's hammer
- Crimping pliers
- Diagonal cutting pliers
- Point-nosed pliers
- Multimeter
- 6-pc precision screwdriver
- Measuring tape
 2m×13mm
- Hacksaw frame
- Insulating tape
- Adjustable wrench
 8"/200mm
- 8-pc ball point hex key set long arm
- Voltage tester
- Rosin core solder
- Utility cutter
- Flashlight
- Soldering iron
- Tweezers
- Spinner handle
- Bit adapter
- Soldering iron stand
- 22-pc bits
- Blow case

ITEM NO.	SIZE	BOX(CTN/SET)
K0005	59-pc set	1/6

18-pc socket set 1/2"DR.



- Ratchet handle
- Sliding T-bar 1/2dr*10
- Ext bar 1/2dr*21mm
- Spark plug 1/2dr*5
- 13-pc socket 6pt :
 1/2DR*8, 10, 11, 12, 13, 14, 15, 16, 17, 18, 19, 22, 24mm
- Blow mold case

ITEM NO.	SIZE	BOX(CTN/SET)
K0007	18-pc set	1/5

32-pc socket set 1/2"DR.



- Universal joint
- Adapter
- 2-pc extension bar 5", 10"
- 2-pc spark plug: 16, 21mm
- 6-pc socket 12pt:
 10, 12, 14, 15, 17, 19mm
- 19-pc socket 6pt :
 8, 9, 10, 11, 12, 13, 14, 15, 16, 17, 18, 19, 20, 21, 22, 24, 27, 30, 32mm
- Blow mold case

ITEM NO.	SIZE	BOX(CTN/SET)
K0008	32-pc set	1/4

Socket/bit set---ratchet handle



- 1pc mini ratchet T-handle.
- 1pc 25mm adaptor.
- 1pc magnetic extension shaft.
- 3pcs slotted: 3.0, 5.0, 6.0mm.
- 3pcs phillips: ph1, ph2, ph3.
- 3pcs torx: t10, t15, t20
- 6pcs sockets: 5, 6, 7, 8, 9, 10mm



ITEM NO.	SIZE	BOX(CTN/SET)
K0027	18-pc set	6/48

21-pc socket & bit set



- 1pc T type screwdriver bits and socket handle
- 1pc extension socket bar
- 9pcs Socket: 5, 6, 7, 8, 9, 10, 11, 12, 13mm
- 10pcs Screwdriver Bits:
 - Phillips: PH1, PH2
 - Slotted: 4.0, 5.0mm
 - Pozidriv: PZ1, PZ2
 - Torx: T15, T20
 - Hex: 4.0, 5.0mm

ITEM NO.	SIZE	BOX(CTN/SET)
K0006	21-pc set	6/24

25-pc T-handle socket & bit set



Stronger handle for better grip
Plastic case for storage

ITEM NO.	SIZE	BOX(CTN/SET)
K0006A	25-pc set	6/24

32-pc socket set 1/2"DR.



- 22-1/2" DR. 12pt. Reg. Sockets: 8, 9, 10, 11, 12, 13, 14, 15, 16, 17, 18, 19, 20, 21, 22, 23, 24, 26, 27, 28, 30, 32mm
- 3-1/2" DR. Extension bars: 3" 5" 10"
- 1-Adapter 3 way: F1/2-M3/8
- 1-Screwdriver: 52mm
- 1-1/2" DR. Universal joint
- 1-1/2" DR. Ratchet handle
- 2-1/2" DR. Spark plug sockets: 16mm 21mm
- 1-1/2" DR. I-type handle: 10"

ITEM NO.	SIZE	BOX(CTN/SET)
K0108	32-pc set	1/4

18-pc socket set 1/2"DR.



- 1/2"dr. sockets: 8, 10, 11, 12, 13, 14, 15, 17, 19, 21, 22, 23, 27mm
- 1/2"dr. Deep socket: 21mm
- 1/2"dr. Sliding T bar: 250mm
- 1/2"dr. Extension bar: 120mm
- 1/2"dr. Ratchet handle: 1/2"×250mm
- Metal case: 370×150×50mm

ITEM NO.	SIZE	BOX(CTN/SET)
K0009	18-pc set	1/10

26-pc socket set 1/2"DR.



- 1/2"dr. Sockets: 10, 11, 12, 13, 14, 15, 16, 17, 18, 19, 20, 21, 22, 23, 24, 27, 30, 32mm
- 1/2"dr. Deep sockets: 16- 21mm
- 1/2"dr. Sliding T bar: 250mm
- 1/2"dr. Universal joint
- 1/2"dr. Extension bar: 5"- 10"
- 1/2"dr. Ratchet handle: 1/2"×250mm
- Metal case: 370×150×50mm

ITEM NO.	SIZE	BOX(CTN/SET)
K0010	26-pc set	1/4

82-pc socket set 1/2"DR.+1/4"DR.



- 9-1/4"dr. 6pt. Reg. Socket: 4, 4.5, 5, 5.5, 6, 7, 8, 9, 10mm
- 9-1/4"dr. 6pt. Deep. Socket: 5, 5.5, 6, 7, 8, 9, 10, 11, 12, 13mm
- 21-1/2"dr. 6pt. Reg. Socket: 8, 9, 10, 11, 12, 13, 14, 15, 16, 17, 18, 19, 20, 21, 22, 23, 24, 25, 27, 30, 32mm
- 4-1/2"dr. 6pt. Deep. Socket: 14, 15, 17, 19mm
- 24-1/4"dr. Bit x 25mm L:
 - FD-4, FD-5.5, FD-6.5, FD-7,
 - PH-#1, PH-#2, PH-#3, PZ-#1, PZ-#2, PZ-#3,
 - HW-3, HW-4, HW-5, HW-6, HW-8,
 - HW-10, TX-8,
 - TX-10, TX-15, TX-20, TX-25,
 - TX-27, TX-30, TX-40
- 2-1/4"dr. Extension bar: 2", 4"
- 2-1/2"dr. Extension bar: 5", 10"
- 1-1/4"dr. Universal joint
- 1-1/2"dr. Universal joint
- 1-1/4"dr. Extension spinner handle
- 1-1/4"dr. Sliding T -handle
- 1-1/4"dr. Ratchet handle 45T
- 1-1/2"dr. Tatchet handle 45T
- 1-1/4"dr. Coupler adapter 1/4x1/4"
- 1-3/8Fx1/2M 3-way adapter
- 1-1/2"dr. Flexible handle 15"
- 2-1/2"dr. Spark plug: 16, 21mm

ITEM NO.	SIZE	BOX(CTN/SET)
K0015	82-pc set	1/2



120-pc socket set

1/2"DR.+1/4"DR.+3/8"DR.



- 10-1/4"dr. 6pt. Reg. Socket : 4,5,6,7,8,9,10,11,12,13mm
- 10-1/4"dr. 6pt. Reg. Socket : 5/32",3/16" ,7/32",1/4",9/32",5/16",11/32",3/8",7/16",1/2"
- 4-1/4"dr. 6pt. Reg. Socket : 8 ,9 ,10,12mm
- 11-3/8"dr. 6pt. Reg. Socket : 9,10,11,12,13,14 ,15,16,17,18,19mm
- 9-3/8"dr. 6pt.reg.socket : 3/8", 7/16",1/2",9/16",5/8",11/16",3/4",13/16",7/8"
- 4-3/8"dr. 6pt. Deep. Socket : 13,14,15,17mm
- 8-3/8"dr. Star socket : E8,e10,e11,e12,e14,e16,e18,e20
- 7-1/2"dr. 6pt. Reg. Socket : 20,21,22,24,27,30,32mm
- 4-1/2"dr. 6pt.reg. Socket : 15/16",1",1-1/16",1-1/4"
- 4-1/2"dr. Imp reg. Socket : 17,19,21,23mm
- 17-3/8"dr. Bit socket : PH-#1, PH-#2, PZ-#1, PZ-#2, HW-3, HW-4, HW-5, HW-6, FD-5.5, FD-6.5, TX-20, TX-30, TX-40, TX-45, TX-50, TX-55, TX-60
- 10-1/4"dr. Bit x 25mm L : PH-#1,PH-#2,PH-#3 , TX-10,TX-15,TX-20, TX-25, TX-27,TX-30,TX-40
- 1-1/4"dr. Extension bar : 2"
- 2-3/8"dr. Extension bar : 3",6"
- 2-1/2"dr. Extension bar : 5",10"
- 1-1/4"dr. Universal joint
- 1-3/8"dr. Universal joint
- 1-1/2"dr.universal joint
- 1-1/4"dr. Extension spinner handle
- 1-1/4"dr. Ratchet handle 45T
- 1-3/8"dr. Ratchet handle 45T
- 1-1/2"dr. Ratchet handle 45T
- 1-1/4"dr. Coupler adapter 1/4x1/4"
- 2-3/8"dr. Spark plug socket : 16,21mm
- 11-combination wrench : 8,9,10,11,12,13,14, 16,17,18,19mm

ITEM NO.	SIZE	BOX(CTN/SET)
K0017	120-pc set	1/2

121-pc socket set

1/2"DR.+1/4"DR.+3/8"DR.



- 10-1/4" Dr. 6pt. Reg. Sockets: 4-5-6-7-8-9-10-11-12-13mm
- 4-1/4" Dr. 6pt. Deep Sockets: 8-9-10-12mm
- 1-1/4" Dr. Ratchet Handle
- 1-1/4" Dr. Extension Bar 2"
- 1-1/4" Dr. Universal Joint
- 1-1/4" Dr. 1/4" Hexagon Bit Coupler
- 1-1/4" Dr. Spinner Handle
- 7-1/4" Dr. Bits: T10-t15-t20-t25-t27-t30-t40
- 11-3/8" Dr. 6pt. Reg. Sockets: 9-10-11-12-13-14-15-16-17-18-19mm
- 4-3/8" Dr. 6pt.deep Sockets: 13-14-15-17mm
- 8-3/8" Dr. Star Reg. Sockets: E8-e10-e11-e12-e14-e16-e18-e20
- 2-3/8" Dr. Bit Sockets: Fd5.5-6.5mm
- 2-3/8" Dr. Bit Sockets: Ph1-ph2
- 2-3/8" Dr. Bit Sockets: Pz1-pz2
- 4-3/8" Dr. Bit Sockets: Hw3-4-5-6mm
- 7-3/8" Dr. Bit Sockets: Tx20-30-40-45-50-55-60
- 1-3/8" Dr. Ratchet Handle
- 2-3/8" Dr. Extension Bar 3"-6"
- 2-3/8" Dr. Spark Plug Socket 16-21mm
- 1-3/8" Dr. Universal Joint
- 7-1/2" Dr. 6pt. Reg. Metric Sockets: 20-21-22-24-27-30-32mm
- 1-1/2" Dr. Ratchet Handle
- 2-1/2" Dr. Extension Bar 5"-10"
- 1-1/2" Dr. Universal Joint
- 11-combination Wrenches:8-10-11-12-13-14-15-16-17-18-19mm
- 1-3/8"fx1/4"m Adapter
- 1-3/8"fx1/2"m Adapter
- 1-oil Filter Wrench 63-102mm
- 1-1/2" Dr. Torx Bit Socket T-52
- 1-electric Circuit Tester 6v/12v24v
- 9-hex Key Wrenches (1.5,2,2.5,3,4,5,6,8,10)
- 2-go Thru Screwdriver 6x100mm, 2x100mm
- 18-6.3mm Bits: Fd4-5.5-6.5 Ph1-2pz1-2hw 3-4-5-6tx10-15-20-25-27-30-40

ITEM NO.	SIZE	BOX(CTN/SET)
K0171	121-pc set	1/2

38-pc socket set

1/4"DR.



- 14-1/4"dr. Reg. Sockets: 3.5,4.0, 4.5,5.0,5.5,6.0,7.0,8.0,9.0, 10.0,11.0,12.0,13.0,14.0mm
- 18-bit Sockets: Fd-4,Fd-5.5,Fd-6.5,Ph-1,Ph-2, Pz-1,Pz-2,Hw-03,Hw-04,Hw-05,Hw-06,Hw-08 Tx-10,Tx-15,Tx-20,Tx-25,Tx-30,Tx-40
- 2-extension Ar: 2",4"
- 1-ratchet Handle
- 1-sliding T Bar
- 1-universal Joint
- 1-spinner Handle

ITEM NO.	SIZE	BOX(CTN/SET)
K0019	38-pc set	1/12

58-pc socket set

3/8"DR.



- 18-3/8"dr. reg. sockets: 6,7,8, 9,10,11,12,13, 14,15,16,17,18,19,2 ,21,22,24mm
- 9-3/8"dr. deep sockets: 8,10,11,12, 13,14,15,17,19mm
- 24-bit sockets: fd-4,fd-5.5,fd-7.0,ph-1,ph-2, pz-1, pz-2,pz-3, hw-03,hw-04,hw-0,hw-06,hw-07, hw-08,hw-10, tx-10, tx-15, tx-20 , tx-2 ,tx-30,tx-40 , tx-45, tx-50,tx-55
- 2-extension ar: 3",10"
- 1-ratchet handle
- 1-spark plug socket 16-21mm
- 1-universal joint
- 1-1/2"fx3/8"m 3 way adapter

ITEM NO.	SIZE	BOX(CTN/SET)
K0020	58-pc set	1/5

Bit assortment - 40pc set



- 7-H10X30L:H4,H5,H6,H7,H8,H10,H12
- 7-H10X75L:H4,H5,H6,H7,H8,H10,H12
- 5-H10X30L:M5,M6,M8,M10,M12
- 5-H10X75L:M5,M6,M8,M10,M12
- 7-H10X30L:T20,T25,T30,T40,T50,T55
- 7-H10X75L:T20,T25,T30,T40,T50,T55
- 1-3/8DR.Coupler
- 1-1/4DR.Coupler

ITEM NO.	SIZE	BOX(CTN/SET)
K0021	40-pc set	1/10

26-pc socket set 3/4"DR.



- 1-20" Sliding T handle
- 1-8" Extension 1-Adapter
- 16-3/4"Dr.sockets:21,22,23,24,26,27,28,29,30,31,32,34,36,38,41,46mm
- 4-1"Dr.sockets:50,55,60,65mm
- 1-20"Extension bar
- 1-5" L handle
- 1-3/4"Dr.reversible ratchet.

ITEM NO.	SIZE	BOX(CTN/SET)
K0022	26-pc set	1/2

21-pc socket set 1"DR.



- 1-20" Sliding T handle
- 1-8" Extension bar
- 1-16"extension bar
- 1-1"Dr.reversible ratchet
- 16-1"Dr.sockets:30,31,32,34,36,38,41,46,48,50,55,60,65,70,75,80mm

ITEM NO.	SIZE	BOX(CTN/SET)
K0023	21-pc set	1/1

12-pc socket wrench set

1/2"DR.



- Material:cr.v.steel
 1-pc ratchet handle
 1-pc plastic store case
 10-pcs 12.5mm-1/2" regular sockets:
 8, 9, 10, 11, 12, 13, 14, 15, 17, 19mm

ITEM NO.	SIZE	BOX(CTN/SET)
K0024	12-pc set	4/16

12-pc socket wrench set

3/8"DR.



- Material:cr.v.steel 1-pc ratchet handle
 1-pc plastic store case
 10-pcs 10mm-3/8" regular sockets:
 8, 10, 11, 12, 13, 14, 15, 16, 17, 18mm

ITEM NO.	SIZE	BOX(CTN/SET)
K0025	12-pc set	6/24

12-pc socket wrench set

1/4"DR.



- Material:cr.v.steel
 1-pc ratchet handle
 1-pc plastic store case
 10-pcs 6.3mm-1/4" regular sockets:
 4, 5, 6, 7, 8, 9, 10, 11, 12, 13mm

ITEM NO.	SIZE	BOX(CTN/SET)
K0026	12-pc set	4/48

Let's make a C-MART choice
C-mart tools





TAIWAN C-MART PRACTICAL TOOLS CO., LTD. / SHANGHAI C-MART TOOLS CO., LTD.

Rubber mallet



- Quality rubber head with hard wood handle

ITEM NO.	SIZE	BOX(CTN/PCS)
G0001-08	8 oz	12/60
G0001-12	12 oz	12/48
G0001-16	16 oz	12/36
G0001-24	24 oz	12/24

Two-way mallet



- Striking caps replaceable if worn-out.
- Hard wood handle

ITEM NO.	SIZE	BOX(CTN/PCS)
G0002-30	30mm	12/60
G0002-40	40mm	12/36

Mallet head replacements



ITEM NO.	SIZE	BOX(CTN/PCS)
G0002A-30-Y	Yellow 30mm	-/60
G0002A-40-Y	Yellow 40mm	-/36
G0002A-30-B	Black 30mm	-/60
G0002A-40-B	Black 40mm	-/36

Dead blow rubber mallet



ITEM NO.	SIZE	BOX(CTN/PCS)
G0003-1	1 LB	6/36
G0003-1.5	1.5 LB	6/24
G0003-2	2 LB	6/18
G0003-3	3 LB	6/12
G0003-4	4 LB	6/12
G0003-5	5 LB	-/6
G0003-6	6 LB	-/6

Claw hammer, wood handle



- Drop forged high carbon steel heat treated and tempered.
- Hard wood handle with plastic end cap

ITEM NO.	SIZE	BOX(CTN/PCS)
G0004	16 oz	6/24

Claw hammer, steel pipe handle with rubber grip



- Drop forged high carbon steel heat treated and tempered.
- Steel pipe handle with plastic grip.

ITEM NO.	SIZE	BOX(CTN/PCS)
G0005-08	8 oz	6/48
G0005-12	12 oz	6/36
G0005-16	16 oz	6/24

Sledge hammer, fibre-glass handle



- Drop forged high carbon steel heat treated and tempered.
- Double-colour fibre-glass handle

ITEM NO.	SIZE	BOX(CTN/PCS)
G0006-03	3 LB	6/12
G0006-04	4 LB	6/12
G0006-06	6 LB	-/6
G0006-08	8 LB	-/6
G0006-10	10 LB	-/4
G0006-12	12 LB	-/2
G0006-16	16LB	1/2
G0006-18	18 LB	1/2

Dead blow/brass hammer



ITEM NO.	SIZE	BOX(CTN/PCS)
G0009	24 oz	6/24

Ball pein hammers



- Drop forged high carbon steel heat treated and tempered.
- Hard wood handle with plastic end cap

ITEM NO.	SIZE	BOX(CTN/PCS)
G0010-0.5	0.5 LB	6/72
G0010-1	1 LB	6/48
G0010-1.5	1.5 LB	6/36
G0010-2	2 LB	6/24

Machinist's hammer



- Drop forged high carbon steel heat treated and tempered.
- Hard wood handle

ITEM NO.	SIZE	BOX(CTN/PCS)
G0011-200	200g	6/72
G0011-300	300g	6/48
G0011-500	500g	6/36
G0011-800	800g	6/24
G0011-1500	1500g	6/12

Claw hammer, fibre-glass handle



- Drop forged high carbon steel heat treated and tempered.
- Fibre-glass handle with soft rubber grip.

ITEM NO.	SIZE	BOX(CTN/PCS)
G0007-08	8 oz	6/36
G0007-12	12 oz	6/36
G0007-16	16 oz	6/36

Welding goggles



ITEM NO.	SIZE	BOX(CTN/PCS)
H0001		20/60

Safety goggles



ITEM NO.	SIZE	BOX(CTN/PCS)
H0002		-/200

Safety goggles



ITEM NO.	SIZE	BOX(CTN/PCS)
H0201		-/200

Led flashlight



ITEM NO.	SIZE	BOX(CTN/PCS)
H0003	One aa battery included	10/100
H0004	Two aa battery included	10/100

Leather working gloves



ITEM NO.	SIZE	BOX(CTN/PCS)
H0005		-/120

Double layer heatproof welding gloves



ITEM NO.	SIZE	BOX(CTN/PCS)
H0006		-/72

Arc welding helmet

- Double-layer lenses
- Strap size adjustable
- To be used together with safety helmet
- Safety helmet to be bought separately



ITEM NO.	SIZE	BOX(CTN/PCS)
H0009		-/25

Arc welding helmet



- Double-layer lenses
- Strap size adjustable

ITEM NO.	SIZE	BOX(CTN/PCS)
H0010		-/25

Arc welding helmet



- Double-layer lenses
- Strap size adjustable

ITEM NO.	SIZE	BOX(CTN/PCS)
H0010B		-/25

Auto-darkening welding helmet



NEW!

MMA TIG MIG

ITEM NO.	SIZE	BOX(CTN/PCS)
H0012		-/1

Auto-darkening welding helmet



NEW!

MMA TIG MIG

ITEM NO.	SIZE	BOX(CTN/PCS)
H0013		-/1

Automatic tie wire twister



6 MONTHS OF QUARANTEED USE

NEW!



ITEM NO.	SIZE	BOX(CTN/PCS)
L0070		-/1

High pressure foot pump



- Single-tube high pressure pump, foot pedaled with gauge
- For inflating bicycle tyres, motorbike tyres, car tyres, inflatable toys and sports gears

ITEM NO.	SIZE	BOX(CTN/PCS)
L0001	55*120	-/20

High pressure foot pump

- Twin-tube high pressure pump, foot pedaled with gauge
- For inflating bicycle tyres, motorbike tyres, inflatable toys and sports gears



ITEM NO.	SIZE	BOX(CTN/PCS)
L0002	55*120	-/10

Hand pump



- Additional cylinder for increased pressure making pumping easier and faster
- For inflating bicycle tyres, motorbike tyres, inflatable toys and sports gears

ITEM NO.	SIZE	BOX(CTN/PCS)
L0003	32*500	-/10

Stealth pump with gauge



ITEM NO.	SIZE	BOX(CTN/PCS)
L0004	32*530mm	-/10

Hand pump



L0005-32

L0005-38

- Presta/schrader valves compatible
- Inflates to maximum 120 psi/8 bar
- Includes 3 inflator needles
- Impact resistant nylon base

ITEM NO.	SIZE	BOX(CTN/PCS)
L0005-32	32x530mm	-/10
L0005-38	38x530mm	-/10

Stealth pump with gauge



- Presta/schrader valves compatible
- Inflates to maximum 120 psi/8 bar
- Includes 3 inflator needles
- Built-in pressure gauge
- Wide stable base

ITEM NO.	SIZE	BOX(CTN/PCS)
L0006	32*685mm	-/10

Magnetizer / Demagnetizer



ITEM NO.	SIZE	BOX(CTN/PCS)
L0008		25/100

Digital multimeter



- Automatic polarity indication
- Data-hold mode
- Overload protection
- Low battery indication

ITEM NO.	SIZE	BOX(CTN/PCS)
L0016		1/20

Digital multimeter

FEATURES

- 3 1/2 digits LCD, max. reading 1999
- Overload protection
- Low battery indication
- Audible continuity



ITEM NO.	SIZE	BOX(CTN/PCS)
L0017		1/20

Digital multimeter



ITEM NO.	SIZE	BOX(CTN/PCS)
L0015		1/60

Laser level



NEW!

Five LED blue rays

- 4V1H1P four vertical lines, one horizontal line and one lower opposite point
- Accuracy: $\pm 1\text{mm}/5\text{m}$
- Working radius: 10m

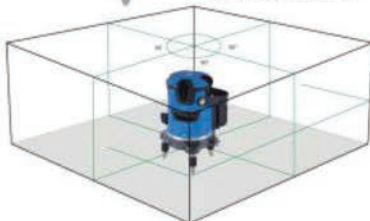

- Osram LED lighting source from Germany
- Wave length: 520nm
- Self leveling mechanism valued at: $\pm 3'$
- Lithium battery powered to ensure up to 8 hours of working time
- Cast iron swivel tripod base
- Impact resistant and dust proof.
- (fall off from any height more than 1 meter not acceptable)
- Working temperature: -10°C — $+45^{\circ}\text{C}$

ITEM NO.	SIZE	BOX(CTN/PCS)
L0063	5 Lines	

Laser level

12 LINES



NEW!

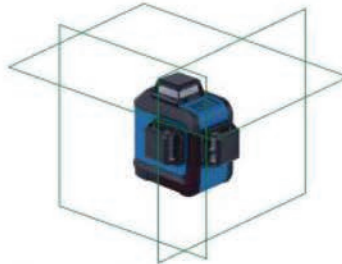

- Type of laser line: 3x360°
- Self leveling mechanism valued at $\pm 3'$
- Accuracy $\pm 1\text{mm}/5\text{m}$
- Slope locking mode: available
- Working temperature -10° — $+45^{\circ}$

ITEM NO.	SIZE	BOX(CTN/PCS)
L0064	12 Lines	

Laser measure



NEW!

- 5-meter steel tape plus 30 meter laser measure.
- USB charged full for a week long use

ITEM NO.	SIZE	BOX(CTN/PCS)
D0028	5m+30m	

Digital voltage tester



ITEM NO.	SIZE	BOX(CTN/PCS)
L0034	135mm	16/128

Digital voltage tester



ITEM NO.	SIZE	BOX(CTN/PCS)
L0035	135mm	16/128

Voltage tester



ITEM NO.	SIZE	BOX(CTN/PCS)
L0036	145mm	24/480

Multifunctional digital tester

LED LIGHT



ITEM NO.	SIZE	BOX(CTN/PCS)
L0033		-/-

Voltage tester



ITEM NO.	SIZE	BOX(CTN/PCS)
L0037	190mm	24/480

3 way screwdriver tester

- slotted screwdriver
- phillips screwdriver
- voltage tester



ITEM NO.	SIZE	BOX(CTN/PCS)
L0038	ph1x4mm	-/120

Auto air-venting grease gun

PATENTED



ITEM NO.	SIZE	BOX(CTN/PCS)
L0025	600cc	1/12

Heavy duty grease gun



ITEM NO.	SIZE	BOX(CTN/PCS)
L0026	600cc	1/12

Professional lever action grease gun



ITEM NO.	SIZE	BOX(CTN/PCS)
L0027	600cc	1/10

Grease gun



ITEM NO.	SIZE	BOX(CTN/PCS)
L0028	450cc	1/12

Grease gun



ITEM NO.	SIZE	BOX(CTN/PCS)
L0029	600cc	1/10

Grease gun soft hose



ITEM NO.	SIZE	BOX(CTN/PCS)
L0030-12	300mm/12"	
L0030-18	450mm/18"	

Grease gun metal hose



ITEM NO.	SIZE	BOX(CTN/PCS)
L0031	175mm/7"	

Grease gun accessories(coupler)



ITEM NO.	SIZE	BOX(CTN/PCS)
L0032		

Pump oiler



ITEM NO.	SIZE	BOX(CTN/PCS)
L0024-250F	FLEXIBLE HOSE 250ml	10/120
L0024-250M	STEEL HOSE 250ml	10/120
L0024-400F	FLEXIBLE HOSE 400ml	10/120
L0024-400M	STEEL HOSE 400ml	10/120

Hand operated pump



Type	Hand crank
Weight	2.16kg
Length	1.36m
Pumping distance	6m
Liquid flow capacity	50L/min
Liquid type	Oil, Light spirits, Heavy oil

ITEM NO.	SIZE	BOX(CTN/PCS)
L0019-25	28L/min	1/6
L0019-32	50L/min	1/6

Plastic oil pump



ITEM NO.	SIZE	BOX(CTN/PCS)
L0020	530mm	10/120

Plastic oil pump



ITEM NO.	SIZE	BOX(CTN/PCS)
L0021	610mm	10/60

Plastic oil pump



ITEM NO.	SIZE	BOX(CTN/PCS)
L0022	1210mm	-/24

Tool box



ITEM NO.	SIZE	BOX(CTN/PCS)
L0045	350mm/14"	-/12
L0046	425mm/17"	1/9
L0461	475mm/19"	1/6

Tool box with trays



ITEM NO.	A(mm)	B(mm)	C(mm)	BOX(CTN/PCS)
L0042-17	430	180	190	1/2
L0042-20	510	218	225	1/2

Hand-away tool box with trays



ITEM NO.	A(mm)	B(mm)	C(mm)	BOX(CTN/PCS)
L0043-18	465	200	195	1/2
L0043-20	495	200	235	1/2

Tool box



ITEM NO.	SIZE	BOX(CTN/PCS)
L0044-360	360mm/14.5"	1/12
L0044-420	420mm/17"	1/12

Three layer tool trolley



ITEM NO.	A(mm)	B(mm)	C(mm)	C1(mm)	BOX(CTN/PCS)
L0053	719	365	663	780	-/1

Three layer tool trolley

Promotional items



ITEM NO.	A(mm)	B(mm)	C(mm)	C1(mm)	BOX(CTN/PCS)
L0053A	719	365	663	780	-/1

Three layer tool trolley with drawer



Max.loading capacity:150kgs

ITEM NO.	A(mm)	B(mm)	C(mm)	C1(mm)	BOX(CTN/PCS)
L0054	737	383	668	785	-/1

Five layer caster cabinet



Max.loading capacity:240kgs

ITEM NO.	A(mm)	B(mm)	C(mm)	C1(mm)	BOX(CTN/PCS)
L0055	724	470	867	1032	-/1

Seven layer caster cabinet



Max.loading capacity:240kgs

ITEM NO.	A(mm)	B(mm)	C(mm)	C1(mm)	BOX(CTN/PCS)
L0056	724	470	867	1032	-/1

Five layer caster cabinet with side cabin



Max.loading capacity:240kgs

ITEM NO.	A(mm)	B(mm)	C(mm)	C1(mm)	BOX(CTN/PCS)
L0057	1035	458	897	1052	-/1

Tool bag



ITEM NO.	SIZE	BOX(CTN/PCS)
L0047	320mm/13"	-/20

Tool bag



ITEM NO.	SIZE	BOX(CTN/PCS)
L0471	350mm/14"	1/10

Tool bag



ITEM NO.	SIZE	BOX(CTN/PCS)
L0048	385mm/15"	1/12

Make-your-own wrench set



You can select wrenches you need and arrange them in set

ITEM NO.	SIZE	BOX(CTN/PCS)
L0049-08	8-pc set	-
L0049-10	10-pc set	-
L0049-12	12-pc set	-

Waist pouch



ITEM NO.	SIZE	BOX(CTN/PCS)
L0050-01	Single	-
L0050-02	Two-pc	-
L0050-03	Three-pc	-

Waist pouch



ITEM NO.	SIZE	BOX(CTN/PCS)
L0050-05	five pc	-

Tool pouch



ITEM NO.	SIZE	BOX(CTN/PCS)
L0052		-/100

Tool pouch belt



ITEM NO.	SIZE	BOX(CTN/PCS)
L0061		-

Cordless drill pouch



ITEM NO.	SIZE	BOX(CTN/PCS)
L0062		-/100

Wrecking bar



ITEM NO.	SIZE	BOX(CTN/PCS)
L0041-18	450mm/18"	5/20
L0041-24	600mm/24"	5/10
L0041-30	750mm/30"	5/10
L0041-36	900mm/36"	4/8
L0041-48	1200mm/48"	3/6
L0041-60	1500mm/60"	3/6





TAIWAN C-MART PRACTICAL TOOLS CO., LTD. / SHANGHAI C-MART TOOLS CO., LTD.

Pneumatic socket wrench

1/2" DR.



- Twin hammer mechanism for steady and potent performance
- Easy adjustable power regulator
- Axle made of carbon steel drop-forged and heat treated
- Handle exhaust
- Ideal for changing tires, assembling work and other workshop applications

ITEM NO.	SIZE	BOX(CTN/PCS)
W0001	plastic box	1/5

Pneumatic socket wrench

1/2" DR.



- Twin hammer mechanism for steady and potent performance
- Easy adjustable power regulator
- Axle made of carbon steel drop-forged and heat treated
- Front exhaust
- Ideal for changing tires, assembling work and other workshop applications

ITEM NO.	SIZE	BOX(CTN/PCS)
W0002		1/-

Pneumatic riveting gun

Professional



ITEM NO.	SIZE	BOX(CTN/PCS)
W0004		1/10

Spray gun



- Nozzle: stainless steel
- Air cap: brass
- Clamp: aluminum

ITEM NO.	SIZE	BOX(CTN/PCS)
W-71G	400cc	1/25
W-71S	600cc	1/10

Spray gun



- Nozzle: stainless steel
- Air cap: brass
- Clamp: aluminum

ITEM NO.	SIZE	BOX(CTN/PCS)
W-77G	400cc	1/25
W-77S	1000cc	1/10

Air screwdriver



ITEM NO.	SIZE	BOX(CTN/PCS)
W0003	10,500r.p.m.	1/30

Air screwdriver



ITEM NO.	SIZE	BOX(CTN/PCS)
W0003B	10,500r.p.m.	1/30

Aluminium air duster



ITEM NO.	SIZE	BOX(CTN/PCS)
L0012-12	12mm	12/120
L0012-80	80mm	12/120

2 cylinder air compressor



ITEM NO.	SIZE	BOX(CTN/PCS)
S0024	-	1/4

Air duster gun



Promotional item

ITEM NO.	SIZE	BOX(CTN/PCS)
L0010-110	110mm	10/140

Air duster gun



INDUSTRIAL QUALITY



Copper sealing valve and German sealing rings



1/4 threaded copper cuppler for better sealing performance and longer life

Stainless steel pipe nozzle with scratch proof rubber cover
Copper sealing valve and German sealing rings
Body and handle made of reinforced nylon
1/4 threaded copper cuppler for better sealing performance and longer life

ITEM NO.	SIZE	BOX(CTN/PCS)
L0011-110	110mm	10/140
L0011-270	270mm	10/100



 **W0007**

Electric drill | 350W

Hole diameter: MaxØ10mm Input Power: 220V-240V-
No Load Speed: 0-3700r/min Rated Frequency: 50Hz/60Hz

ITEM NO.	CHUCK SIZE	BOX(CTN/PCS)
W0007-10	MaxØ10mm	1/10



**Two step speed control
Big torque**

 **W0007B**

Electric drill | 530W

Hole diameter: MaxØ10mm Input Power: 220V-240V-
No Load Speed: 0-1240r/min Rated Frequency: 50Hz/60Hz

ITEM NO.	CHUCK SIZE	BOX(CTN/PCS)
W0007B	Ø10mm	1/10



 **W0008B**

Impact drill | 900W

Hole diameter: MaxØ13mm Input Power: 220V-240V-
No Load Speed: 0-3200r/min Rated Frequency: 50Hz/60Hz

ITEM NO.	CHUCK SIZE	BOX(CTN/PCS)
W0008B	Ø13mm	1/8

W0011-20

Hammer drill | 500W

SDS-plus Double insulated handle for safety
 2 function-hammer and drill Forward/reverse rotation function
 Variable speed switch

Hole diameter: Ø20mm Input Power: 220V-240V-
 No Load Speed: 0-850r/min Rated Frequency: 50Hz/60Hz



ITEM NO.	MAX.HOLE OPENING	BOX(CTN/PCS)
W0011-20	Ø20mm	1/5



W0011-24

Hammer drill | 620W

SDS-plus Double insulated handle for safety
 3 function-hammer, drill and chisel Forward/reverse rotation function
 Variable speed switch

Hole diameter: Ø24mm Input Power: 220V-240V-
 No Load Speed: 0-870r/min Rated Frequency: 50Hz/60Hz



ITEM NO.	MAX.HOLE OPENING	BOX(CTN/PCS)
W0011-24	Ø24mm	1/5



W0011-26

Hammer drill | 800W

SDS-plus Double insulated handle for safety
 3 function-hammer, drill and chisel Forward/reverse rotation function
 Variable speed switch

Hole diameter: Ø26mm Input Power: 220V-240V-
 No Load Speed: 0-900r/min Rated Frequency: 50Hz/60Hz



ITEM NO.	MAX.HOLE OPENING	BOX(CTN/PCS)
W0011-26	Ø26mm	1/4





Heavy-duty combihammer

Double function hammer demolition and chisel

No Load Speed: 850r/min Input Power: 220V-240V~
Impact Frequency: 3200r/min Rated Frequency: 50Hz/60Hz

ITEM NO.	RATED POWER	BOX(CTN/PCS)
W0018-1200	1200W	1/2
W0018-1500	1500W	1/2

W0031-65

Demolition hammer | 1350W

Input Power: 220-240V Rated Frequency: 50Hz No Load Speed: 1800r/min

ITEM NO.	POWER	BOX(CTN/PCS)
W0031-65	1350W	-/1



W0009-650

Angle grinder | 650W

Rated Input Power: 650W M10
Max Disc Diameter: 100-110mm Input Power: 220V-240V~
No Load Speed: 10500r/min Rated Frequency: 50/60Hz

ITEM NO.	BOX(CTN/PCS)
W0009-650	1/10

W0009-710

Angle grinder | 710W

Rated Input Power: 710W M10 / M14
Max Disc Diameter: 100-110mm / 110-125mm Input Power: 220V-240V~
No Load Speed: 11000r/min Rated Frequency: 50/60Hz

ITEM NO.	SPECS.	BOX(CTN/PCS)
W0009-710-M10	M10 100-110mm	1/10
W0009-710-M14	M14 110-125mm	1/10



W0009-1100

Angle grinder | 1100W

Rated Input Power: 1100W M10
 Max Disc Diameter: 100-110mm Input Power: 220V-240V-
 No Load Speed: 10500r/min Rated Frequency: 50/60Hz

ITEM NO.	BOX(CTN/PCS)
W0009-1100	1/10



W0025

Angle grinder | 1100W

Rated Input Power: 1100W M10
 Max Disc Diameter: 100-110mm Input Power: 220V-240V-
 No Load Speed: 10800r/min Rated Frequency: 50/60Hz

ITEM NO.	BOX(CTN/PCS)
W0025	1/10

W0019-355

Cut-off machine | 2000W/15A

Rated Power: 2000W No-load speed: 3800rpm
 Cutting wheel disc size: 355mm Amperate: 15A

ITEM NO.	BOX(CTN/PCS)
W0019-355	-/1



Cutting capacity: **ø25mm**



Cutting capacity: **ø35mm**



W0020-355

Cut-off machine | 2200W/15A

Rated Power: 2200W No-load speed: 3800rpm
 Cutting wheel disc size: 355mm Amperate: 15A

ITEM NO.	BOX(CTN/PCS)
W0020-355	-/1



W0010

Marble cutter | 1260W

Saw blade diameter: Ø105-110mm Input Power: 220V-240V-
Cutting depth: 34mm Rated Frequency: 50/60Hz
No Load Speed: 11000r/min

ITEM NO.	BOX(CTN/PCS)
W0010	1/6

W0027 Circular saw 

Rated voltage: 220V- Rated frequency: 50Hz
Rated power: 1380W / 1800W / 2400W
No-load speed: 5300r/min
Blade diameter: 185 / 235 / 305mm

ITEM NO.	BLADE SIZE	BOX(CTN/PCS)
W0027-07	185mm/7"	1/4
W0027-09	235mm/9"	1/4
W0027-12	305mm/12"	1/4



Gear drive

W0028 

Miter saw | 1600W

Rated Voltage: 110/220V Rated Frequency: 50/60Hz
Input Power: 1600W No Load Speed: 5000r/min
Blade Diameter: 255mm
Max cutting capacity at 90° :75x120mm(HxW)
at 45° :75x80mm(HxW)

ITEM NO.	BOX(CTN/PCS)
W0028	1/-

W0030

Portable blower | 600W 

Rated voltage: 220-240V Rated frequency: 50Hz
Input power: 600W No load speed: 13000r/min
Blowing rate: 2.3m³/min

ITEM NO.	BOX(CTN/PCS)
W0030	1/-



W0012 12V cordless drill



Battery
Li-ion



Li-ion 12V d.c. 1300mAh 230V-50Hz
No-load speed: 0-400 / 0-1400min⁻¹
Max chuck capacity: Ø10mm Keyless Chuck
LED Light Max torque: 25N.m
Drill capacity: Steel Ø10mm Wood Ø22mm
Charge time: 3-5 hour charger

ITEM NO.	BATTERY SPECS.	BOX(CTN/PCS)
W0012	12V 1300mAh	1/10

W0012D BATTERY

W0012P CHARGER

1300mAh



W0013 18V cordless drill



Battery
Li-ion



Li-ion 18V d.c. 1300mAh 230V-50Hz
No-load speed: 0-400 / 0-1400min⁻¹
Torque: 19+1 Setting Rings
Max chuck capacity: Ø10mm Keyless Chuck
LED Light Max torque: 40N.m
Drill capacity: Steel Ø10mm Wood Ø22mm
Charge time: 1 hour charger

ITEM NO.	BATTERY SPECS.	BOX(CTN/PCS)
W0013	18V 1300mAh	1/4

W0013D BATTERY

W0013P CHARGER

1300mAh



W0014 Impact socket wrench



3000mAh / 4000mAh 230V-50Hz No-load speed: 0-2400rpm Max torque: 260Nm
Chuck: 1/2" Motor: Brushless Motor Charge time: 1 hour quick charger Switch: forward & reverse

ITEM NO.	BATTERY SPECS.	BOX(CTN/PCS)
W0014-3.0	21V 3000mAh	1/4
W0014-4.0	21V 4000mAh	1/4

W0014D BATTERY

W0014P CHARGER

3000mAh / 4000mAh



Battery
Li-ion
BRUSHLESS MOTOR

1/2"DR.



W0022 12V cordless drill set



Battery
Li-ion



Capacity:1400mA Li-ion
Drill in steel / wood: Ø10 / 15mm
No load speed: 0-400/1300rpm
Charge time:1hour
Selected durable motor
Max Torque :24N.M

INCLUDES: ONE BLOW MOLD CASE, ONE CHARGER, TWO BATTERIES

ITEM NO.	BATTERY SPECS.	BOX(CTN/PCS)
W0022	12V 1400mAh	1/10

W0022D BATTERY

W0022P CHARGER

1400mAh



W0023 20V cordless drill set



Battery
Li-ion



Capacity:1500mA Li-ion
Drill in steel / wood: Ø10mm
No load speed: 0-400/1300rpm
Charge time:1hour
Selected durable motor
Max Torque :28N.M

INCLUDES: ONE BLOW MOLD CASE, ONE CHARGER, TWO BATTERIES

ITEM NO.	BATTERY SPECS.	BOX(CTN/PCS)
W0023	20V 1500mAh	1/10

W0023D BATTERY

W0023P CHARGER

1500mAh



W0014B 21V impact socket wrench



- ※ Li-ion 21V d.c.
- ※ No-load speed: 0-3200rpm
- ※ Motor: Brushless Motor
- ※ 4000mAh
- ※ Max torque: 350Nm
- ※ Charge time: 2 hour quick charger
- ※ 230V-50Hz
- ※ Chuck: 1/2"
- ※ Switch: forward & reverse

ITEM NO.	BATTERY SPECS.	BOX(CTN/PCS)
W0014B	21V 4000mAh	1/10

W0014BD BATTERY

W0014BP CHARGER

4000mAh



1/2"DR.



Battery
Li-ion
BRUSHLESS MOTOR



W0016

Cordless screwdriver | 3.6V

Voltage: 3.6V Power: Li-ion, 1300mAh
 No-load speed: 210rpm Clutch: 9 setting rings
 Max torque: 3.5Nm Chuck: 1/4" (ϕ 6.35mm)
 Charge time: 3-5 hours Switch: forward & reverse

ITEM NO.	BATTERY SPECS	BOX(CTN/PCS)
W0016	1300mAh	6/12



W0024

Cordless screwdriver | 4V

230V- 50Hz No-load speed: 200min
 Max torque: 4.0Nm Charge time: 5hour

ITEM NO.	BATTERY SPECS	BOX(CTN/PCS)
W0024	4V	6/12

W0021

1500W

Multi-washer high pressure

Rated voltage: 220-240V Rated frequency: 50/60Hz
 Input power: 1500W Flow capacity: 390L/H
 Working pressure: 90Bar Max pressure: 130Bar
 Gross weight: 11Kgs M.R.P (Rs) : 11900.00

ITEM NO.	RATED POWER	BOX(CTN/PCS)
W0021	1500W	1/-



W0026

1200W

Automatic high pressure cleaning machine

Rated voltage: 220-240V Rated frequency: 50/60Hz
 Input power: 1200W Flow capacity: 10L/H
 Working pressure: 8.0Bar Max pressure: 1100Bar
 Gross weight: 11Kgs M.R.P (Rs) : 2800

ITEM NO.	RATED POWER	BOX(CTN/PCS)
W0026	1200W	1/-

Multi-washer high pressure

Rated voltage: 220-240V Rated frequency: 50Hz
 Input power: 1300W 1500W Flow capacity: 360L/H
 Working pressure: 70Bar Max pressure: 105Bar 130Bar
 Gross weight: 13Kgs 15Kgs M.R.P (Rs) : 2800

ITEM NO.	RATED POWER	BOX(CTN/PCS)
W0033	1300W	1/-
W0034	1500W	1/-



W0034 1500W



W0017

Inverter welder machines tig series

Rated Input Voltage(V)	220V	MMA Output Current Range(A)	20-130
Frequency(HZ)	50HZ	Insulation Class	H
Rated Output Current(A)	130	Protection Class	IP21S
Rated Output Voltage(V)	25.2	Suitable Stick Diameter(mm)	2.5-3.2
No-Load Voltage(V)	62	Exterior Size(mm)	375X155X232
Rated Duty Cycle(%)	60	Weight(kgs)	7

ITEM NO.	SIZE	BOX(CTN/PCS)
W0017		1/-

B0009

Electrode holder

• Suitable for professionals. a two year limited Warranty is offered

ITEM NO.	AMP.	BOX(CTN/PCS)
B0009-300	300A	1/48
B0009-500	500A	1/48



INDUSRIAL





TAIWAN C-MART PRACTICAL TOOLS CO., LTD. / SHANGHAI C-MART TOOLS CO., LTD.

Diamond cutting wheel

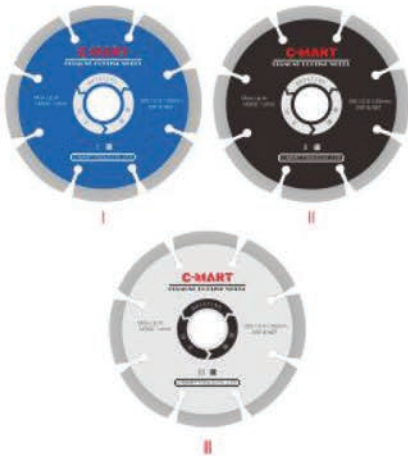

ITEM NO.	SIZE	BOX(CTN/PCS)
A0079	I 105*2.0*20mm	24/144
A0080	II 105*2.0*20mm	24/144
A0081	III 105*2.0*20mm	24/144

Diamond cutting wheel

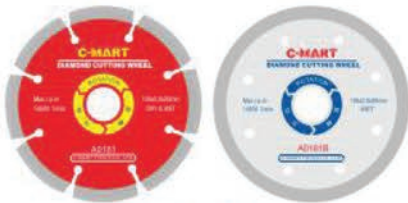

Promotional items

ITEM NO.	SIZE	BOX(CTN/PCS)
A0181	105*2.0*20mm	24/144
A0181B	105*1.2*20mm	24/144

Ultra thin turbo blade



Ultra thin

Promotional items

Especially designed to cut tiles and other ceramic products

ITEM NO.	SIZE	BOX(CTN/PCS)
A0082	105*1.2*20mm	24/144
A0182	105*1.2*20mm	24/144

Diamond cutting wheel, 3-pc set



ITEM NO.	SIZE	BOX(CTN/PCS)
A0087	115*1.2*20mm	

Abrasive cutting wheel



Triple fibre woven

ITEM NO.	SIZE	BOX(CTN/PCS)
A0083-04-1.2	105x1.2x16mm / 4"	20/800
A0083-04-2.0	105x2.0x16mm / 4"	-/400
A0083-12	305mm/12"	-/25
A0083-14	355mm/14"	-/25
A0083-16	405mm/16"	-/25

Abrasive cutting wheel



ITEM NO.	SIZE	BOX(CTN/PCS)
A0084-04-1.0	105x1.0x16mm / 4"	20/800
A0084-04-2.0	105x2.0x16mm / 4"	-/400
A0084-12	305mm/12"	-/25
A0084-14	355mm/14"	-/25
A0084-16	405mm/16"	-/25

Abrasive cutting wheel for stainless steel



ITEM NO.	SIZE	BOX(CTN/PCS)
A0084B-14	355mm/14"	30/-

Tungsten carbide tipped saw blade for aluminum



ITEM NO.	SIZE	BOX(CTN/PCS)
A0085-11030	110mm 30T	-/100
A0085-11040	110mm 40T	-/100
A0085-25480	254mm 80T	-/20
A0085-254100	254mm 100T	-/20

Tungsten carbide tipped saw blade for wood



ITEM NO.	SIZE	BOX(CTN/PCS)
A0086-11024	110 x 24T	
A0086-11030	110 x 30T	
A0086-11040	110 x 40T	
A0086-18524	185 x 24T	
A0086-18540	185 x 40T	
A0086-18560	185 x 60T	
A0086-23030	230 x 30T	
A0086-23040	230 x 40T	
A0086-23060	230 x 60T	
A0086-23080	230 x 80T	
A0086-25430	254 x 30T	
A0086-25440	254 x 40T	
A0086-25460	254 x 60T	
A0086-25480	254 x 80T	
A0086-30540	305 x 40T	
A0086-30560	305 x 60T	
A0086-30580	305 x 80T	
A0086-35540	355 x 40T	
A0086-35560	355 x 60T	
A0086-35572	355 x 72T	
A0086-35580	355 x 80T	
A0086-355100	355 x 100T	

5pcs woodwork drill bit set



4mm 5mm 6mm 8mm 10mm
5/32" 3/16" 1/4" 5/16" 3/8"

ITEM NO.	SIZE	BOX(CTN/SE)
A0118-05	5-pc set	20/100

8pcs masonry drill bit set



3mm 4mm 5mm 6mm
1/8" 5/32" 3/16" 1/4"
7mm 8mm 9mm 10mm
9/32" 5/16" 11/32" 3/8"

ITEM NO.	SIZE	BOX(CTN/SE)
A0118-08	8-pc set	10/100

5pcs masonry drill bit set



4mm 5mm 6mm 8mm 10mm
5/32" 3/16" 1/4" 5/16" 3/8"

ITEM NO.	SIZE	BOX(CTN/SE)
A0119-05	5-pc set	20/100

8pcs masonry drill bit set



3mm 4mm 5mm 6mm 7mm 8mm 9mm 10mm
1/8" 5/32" 3/16" 1/4" 9/32" 5/16" 11/32" 3/8"

ITEM NO.	SIZE	BOX(CTN/SET)
A0119-08	8-pc set	10/100

9pcs sorted drill bit set



5mm 6mm 8mm
3/16" 1/4" 5/16"

5mm 6mm 8mm
3/16" 1/4" 5/16"

5mm 6mm 8mm
3/16" 1/4" 5/16"

ITEM NO.	SIZE	BOX(CTN/SET)
A0120-09	9-pc set	10/100

16pcs sorted drill bit set



2mm 3mm 4mm 5mm 6mm 8mm
5/64" 1/8" 5/32" 3/16" 1/4" 5/16"

4mm 5mm 6mm 8mm
5/32" 3/16" 1/4" 5/16"

10mm 4mm 5mm 6mm 8mm 10mm
3/8" 5/32" 3/16" 1/4" 5/16" 3/8"

ITEM NO.	SIZE	BOX(CTN/SET)
A0120-16	16-pc set	10/100

High speed twist drills

Dual coloured, rolled



ITEM NO.	SIZE	BOX(CTN/PCS)
A0200	1-13mm	

Masonry drills



• High carbon steel, carbide-tipped

ITEM NO.	SIZE	BOX(CTN/SET)
A0097	4.0-10.0mm	

Hss straight shank twist drills



• Made of high speed steel, titanium coated

ITEM NO.	SIZE	REMARKS
A0100-0.5	0.5mm	No coating
A0100-0.6	0.6mm	No coating
A0100-0.7	0.7mm	No coating
A0100-0.8	0.8mm	No coating
A0100-0.9	0.9mm	No coating
A0100	1.0-13.5mm	Coating

Hss straight shank twist drill set

A0100A
1.5 2.0 2.5 3.0 3.2 3.5 4.0 4.5
4.8 5.0 5.5 6.0 6.5

A0100C
1.0 1.5 2.0 2.5 3.0 3.5 4.0 4.5
5.0 5.5 6.0 6.5 7.0 7.5 8.0 8.5
9.0 9.5 10.0

A0100B
1.0 1.5 2.0 2.5 3.0 3.5 4.0 4.5
5.0 5.5 6.0 6.5 7.0 7.5 8.0 8.5
9.0 9.5 10.0 10.5 11.0 11.5
12.0 12.5 13.0



ITEM NO.	SIZE	BOX(CTN/SET)
A0100A	13pc-set	1/50
A0100C	19pc-set	1/20
A0100B	25pc-set	1/10

Hammer drills



ITEM NO.	SIZE	BOX(CTN/PCS)
A0098-06110	6x110mm	
A0098-08110	8x110mm	
A0098-10110	10x110mm	
A0098-06150	6x150mm	
A0098-08150	8x150mm	
A0098-10150	10x150mm	
A0098-12150	12x150mm	
A0098-14150	14x150mm	
A0098-16150	16x150mm	
A0098-10300	10x300mm	
A0098-12350	12x350mm	
A0098-14350	14x350mm	
A0098-16350	16x350mm	
A0098-18350	18x350mm	
A0098-20350	20x350mm	
A0098-22350	22x350mm	
A0098-25350	25x350mm	
A0098-1/4110	1/4" 110mm	
A0098-5/16110	5/16" 110mm	
A0098-3/8110	3/8" 110mm	
A0098-1/4150	1/4" 150mm	
A0098-5/16150	5/16" 150mm	
A0098-3/8150	3/8" 150mm	
A0098-1/2150	1/2" 150mm	
A0098-9/16150	9/16" 150mm	
A0098-5/8150	5/8" 150mm	

Taper shank twist drills



ITEM NO.	SIZE	ITEM NO.	SIZE
A0099-13.5	13.5mm	A0099-36.0	36mm
A0099-14.0	14mm	A0099-36.5	36.5mm
A0099-14.5	14.5mm	A0099-37.0	37mm
A0099-15.0	15mm	A0099-37.5	37.5mm
A0099-15.5	15.5mm	A0099-38.0	38mm
A0099-16.0	16mm	A0099-38.5	38.5mm
A0099-16.5	16.5mm	A0099-39.0	39mm
A0099-17.0	17mm	A0099-39.5	39.5mm
A0099-17.5	17.5mm	A0099-40.0	40mm
A0099-18.0	18mm	A0099-40.5	40.5mm
A0099-18.5	18.5mm	A0099-41.0	41mm
A0099-19.0	19mm	A0099-41.5	41.5mm
A0099-19.5	19.5mm	A0099-42.0	42mm
A0099-20.0	20mm	A0099-42.5	42.5mm
A0099-20.5	20.5mm	A0099-43.0	43mm
A0099-21.0	21mm	A0099-43.5	43.5mm
A0099-21.5	21.5mm	A0099-44.0	44mm
A0099-22.0	22mm	A0099-44.5	44.5mm
A0099-22.5	22.5mm	A0099-45.0	45mm
A0099-23.0	23mm	A0099-45.5	45.5mm
A0099-23.5	23.5mm	A0099-46.0	46mm
A0099-24.0	24mm	A0099-46.5	46.5mm
A0099-24.5	24.5mm	A0099-47.0	47mm
A0099-25.0	25mm	A0099-47.5	47.5mm
A0099-25.5	25.5mm	A0099-48.0	48mm
A0099-26.0	26mm	A0099-48.5	48.5mm
A0099-26.5	26.5mm	A0099-49.0	49mm
A0099-27.0	27mm	A0099-49.5	49.5mm
A0099-27.5	27.5mm	A0099-50.0	50mm
A0099-28.0	28mm	A0099-51.0	51mm
A0099-28.5	28.5mm	A0099-52.0	52mm
A0099-29.0	29mm	A0099-53.0	53mm
A0099-29.5	29.5mm	A0099-54.0	54mm
A0099-30.0	30mm	A0099-55.0	55mm
A0099-30.5	30.5mm	A0099-56.0	56mm
A0099-31.0	31mm	A0099-57.0	57mm
A0099-31.5	31.5mm	A0099-58.0	58mm
A0099-32.0	32mm	A0099-59.0	59mm
A0099-32.5	32.5mm	A0099-60.0	60mm
A0099-33.0	33mm	A0099-61.0	61mm
A0099-33.5	33.5mm	A0099-62.0	62mm
A0099-34.0	34mm	A0099-63.0	63mm
A0099-34.5	34.5mm	A0099-64.0	64mm
A0099-35.0	35mm	A0099-65.0	65mm
A0099-35.5	35.5mm		

Hammer chisel-flat



CR-V.

ITEM NO.	SIZE	BOX(CTN/PCS)
A0981-14	14x250mm	12/72
A0981-17	17x280mm	12/72

Hammer chisel-pointed



CR-V.

ITEM NO.	SIZE	BOX(CTN/PCS)
A0982-14	14x250mm	12/72
A0982-17	17x280mm	12/72

Hss solid ground machine taps



ITEM NO.	SIZE	BOX(CTN/PCS)
A1100-2.0	M2	10/-
A1100-2.5	M2.5	10/-
A1100-03	M3	10/-
A1100-04	M4	10/-
A1100-05	M5	10/-
A1100-06	M6	10/-
A1100-08	M8	10/-
A1100-10	M10	5/-
A1100-12	M12	5/-



Lock installation kit



ITEM NO.	SIZE	BOX(CTN/SET)
A0102	2-1/8"	10/60

Lock installation kit



ITEM NO.	SIZE	BOX(CTN/SET)
A0103	2-1/8"	6/36

TCT hole saw



鑽鐵 (For metal)



ITEM NO.	SIZE	BOX(CTN/PGS)
A2103	Ø15 - Ø23mm	10/340
A2103	Ø24 - Ø28mm	10/240
A2103	Ø30 - Ø40mm	10/120
A2103	Ø42 - Ø55mm	10/72
A2103	Ø60 - Ø63mm	1/96
A2103	Ø70mm	1/80
A2103	Ø75 - Ø80mm	1/60
A2103	Ø90mm	1/48
A2103	Ø100mm	1/36

TCT hole saw

(For glass)



ITEM NO.	SIZE	BOX(CTN/PGS)
A3103-06	6mm	10/400/4000
A3103-08	8mm	10/400/4000
A3103-10	10mm	10/400/4000
A3103-12	12mm	10/400/4000
A3103-14	14mm	10/400/4000
A3103-16	16mm	10/400/4000
A3103-18	18mm	10/400/4000
A3103-20	20mm	10/400/4000
A3103-21	21mm	2/80/800
A3103-22	22mm	2/48/480
A3103-24	24mm	2/48/480
A3103-25	25mm	2/48/480
A3103-27	27mm	2/48/480
A3103-28	28mm	2/48/480
A3103-30	30mm	2/40/400
A3103-32	32mm	2/30/300
A3103-34	34mm	2/30/300
A3103-35	35mm	2/30/300
A3103-38	38mm	2/24/240
A3103-40	40mm	2/24/240
A3103-42	42mm	2/24/240
A3103-45	45mm	2/16/160
A3103-50	50mm	2/12/120
A3103-53	53mm	2/12/120
A3103-55	55mm	2/12/120
A3103-60	60mm	2/126
A3103-65	65mm	2/126
A3103-70	70mm	2/100
A3103-75	75mm	2/72
A3103-80	80mm	2/72
A3103-85	85mm	2/60
A3103-90	90mm	2/60
A3103-95	95mm	2/50
A3103-100	100mm	2/50
A3103-105	105mm	2/30
A3103-110	110mm	2/30
A3103-115	115mm	2/30
A3103-120	120mm	2/30
A3103-125	125mm	2/30

8-pc hole saw set (for wood)



HOLE SAW SIZE: 64mm 76mm 89mm
102mm 127mm

ITEM NO.	SIZE	BOX(CTN/SET)
A0110	8-pc set	1/20

11-pc hole saw set (for wood)

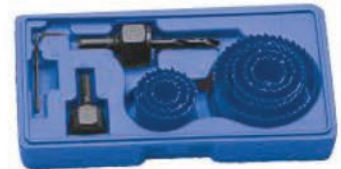

HOLE SAW SIZE: 19mm 22mm 29mm 32mm
38mm 44mm 51mm 64mm

ITEM NO.	SIZE	BOX(CTN/SET)
A0111	11-pc set	1/40

16-pc hole saw set (for wood)



12 pieces of hole saws sizes:
19.22.29.32.38.44.51.64.76.89.102.127mm
1 3/8" mandrel 1 1/4" drill bit(2" long) with mandrel
1 drive plate 1 hex wrench 1 blow molded storage case

ITEM NO.	SIZE	BOX(CTN/SET)
A0112	16-pc set	1/20

Adjustable hole cutter



A0109-30300
30-300mm



A0109-30200
30-200mm



A0109-30120
30-120mm

- ※ Alloy steel cutter blades heat treated
- ※ Whole set includes one adjustable hole cutter drill, one 6mm hex key wrench and one plain brad point drill
- ※ Use after tightly fixing cutting blade screws with attached hex key wrench
- ※ Do not drill metal

Suitable for none metal board
such as plywood and plasterboard

S2 BITS FOR PNEUMATIC & ELECTRIC SCREWDRIVERS

C0040

Double end bits-Phillips

1/4" DR.



ITEM.	H1	PH	L
C0040-PH1-65	6.35mm--1/4"	PH1	65mm
C0040-PH1-100	6.35mm--1/4"	PH1	100mm
C0040-PH1.5-65	6.35mm--1/4"	PH1.5	65mm
C0040-PH2-65	6.35mm--1/4"	PH2	65mm
C0040-PH3-65	6.35mm--1/4"	PH3	65mm
C0040-PH2-100	6.35mm--1/4"	PH2	100mm
C0040-PH2-150	6.35mm--1/4"	PH2	150mm

C0402

Single end bits-torx

1/4" DR.



ITEM.	H1	TX	L
C0402-T10-50	6.35mm--1/4"	T10	50mm
C0402-T15-50	6.35mm--1/4"	T15	50mm
C0402-T20-50	6.35mm--1/4"	T20	50mm
C0402-T25-50	6.35mm--1/4"	T25	50mm
C0402-T30-50	6.35mm--1/4"	T30	50mm

C0404

Ø4 phillips





ITEM.	Ø	Ø1	PH	L
C0404-PH00-1.6	Ø4	Ø1.6	PH00	40mm
C0404-PH0-2.0	Ø4	Ø2.0	PH0	40mm
C0404-PH0-2.5	Ø4	Ø2.5	PH0	40mm
C0404-PH1-3.0	Ø4	Ø3.0	PH1	40mm
C0404-PH2-4.0	Ø4	Ø4.0	PH2	40mm

C0406

Ø6 phillips





ITEM.	Ø	Ø1	PH	L
C0406-PH0-2.0	Ø6	Ø2.0	PH0	60mm
C0406-PH1-3.0	Ø6	Ø3.0	PH1	60mm
C0406-PH1-4.0	Ø6	Ø4.0	PH1	60mm
C0406-PH2-4.0	Ø6	Ø4.0	PH2	60mm
C0406-PH2-5.0	Ø6	Ø5.0	PH2	60mm
C0406-PH2-6.0	Ø6	Ø6.0	PH2	60mm

C0040B

Double end bits-Phillips

1/4" DR.



ITEM.	H1	H	L
C0040B-PH1-65	6.35mm--1/4"	PH1	65mm
C0040B-PH2-65	6.35mm--1/4"	PH2	65mm
C0040B-PH1-110	6.35mm--1/4"	PH1	110mm
C0040B-PH2-110	6.35mm--1/4"	PH2	110mm

C0040C

Double end bits-Phillips S2

1/4" DR.



ITEM.	H1	H	L
C0040C-PH1-65	6.35mm--1/4"	PH1	65mm
C0040C-PH2-65	6.35mm--1/4"	PH2	65mm

C0401

Single end bits-hex

1/4" DR.



ITEM.	H1	H	L
C0401-H3-50	6.35mm--1/4"	H3	50mm
C0401-H4-50	6.35mm--1/4"	H4	50mm
C0401-H5-50	6.35mm--1/4"	H5	50mm
C0401-H6-50	6.35mm--1/4"	H6	50mm
C0401-H2.5-50	6.35mm--1/4"	H2.5	50mm

C0403

Single end bits-Phillips

1/4" DR.



ITEM.	H1	PH	Ø	L
C0403-PH1-3.0	6.35mm--1/4"	PH1	Ø3.0	50mm
C0403-PH1-4.5	6.35mm--1/4"	PH1	Ø4.5	50mm
C0403-PH2-4.5	6.35mm--1/4"	PH2	Ø4.5	50mm
C0403-PH2-6.0	6.35mm--1/4"	PH2	Ø6.0	50mm

C0405

Ø5 phillips





ITEM.	Ø	Ø1	PH	L
C0405-PH00-1.6	Ø5	Ø1.6	PH00	50mm
C0405-PH0-2.0	Ø5	Ø2.0	PH0	50mm
C0405-PH0-2.5	Ø5	Ø2.5	PH0	50mm
C0405-PH1-3.0	Ø5	Ø3.0	PH1	50mm
C0405-PH1-4.0	Ø5	Ø4.0	PH1	50mm
C0405-PH2-4.0	Ø5	Ø4.0	PH2	50mm
C0405-PH2-5.0	Ø5	Ø5.0	PH2	50mm

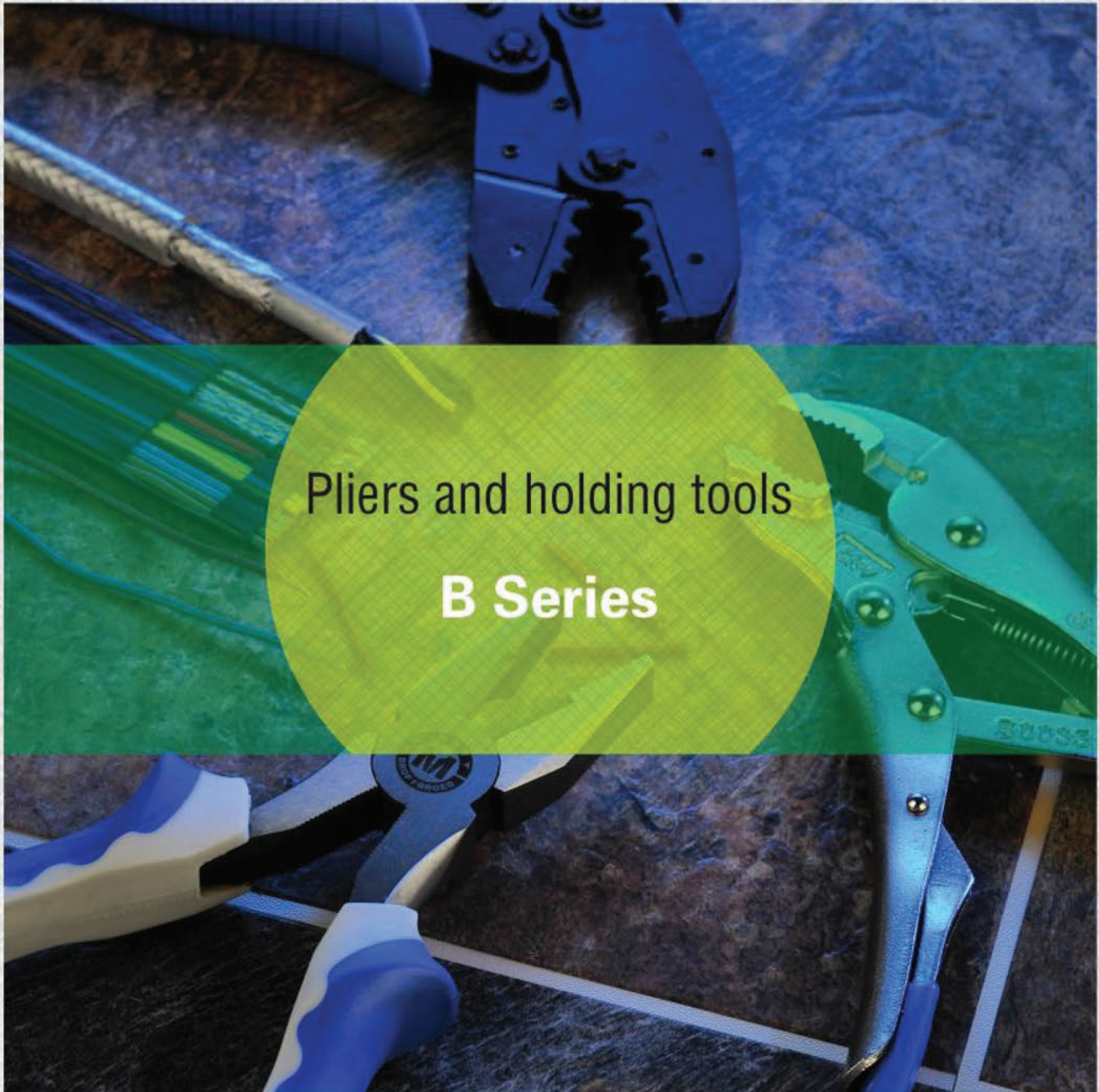

Pliers and holding tools
B Series

TAIWAN C-MART PRACTICAL TOOLS CO., LTD. / SHANGHAI C-MART TOOLS CO., LTD.

Lineman's pliers

CR-V.



WIRE Ø 3.4mm
SOFT WIRE Ø 4.0mm

- Drop forged from chrome vanadium steel.
- Cutting edges induction hardened.
- Double-color handle.

ITEM NO.	SIZE	BOX(CTN/PCS)
B0144-06	150mm/6"	6/72
B0144-07	175mm/7"	6/60
B0144-08	200mm/8"	6/48

Point-nosed pliers

CR-V.



WIRE Ø 1.5mm
SOFT WIRE Ø 2.6mm

- Drop forged from chrome vanadium steel.
- Cutting edges induction hardened.
- Double-color handle.

ITEM NO.	SIZE	BOX(CTN/PCS)
B0154-06	150mm/6"	6/72
B0154-07	175mm/7"	6/60
B0154-08	200mm/8"	6/48

Diagonal cutting pliers

CR-V.



WIRE Ø 1.9mm
SOFT WIRE Ø 3.2mm

- Drop forged from chrome vanadium steel.
- Cutting edges induction hardened.
- Double-color handle.

ITEM NO.	SIZE	BOX(CTN/PCS)
B0164-06	150mm/6"	6/72
B0164-07	175mm/7"	6/60
B0164-08	200mm/8"	6/48

Lineman's pliers



※ Cutting edges induction quenched

Hrc:58-62

※ Dropped forged of cr.v.steel,fully heat treated

※ Double-colour handle ergo-shaped

※ Applicable terminals:1.25-5.5mm



※ Cutting edges
induction
quenched
Hrc:58-62

※ Dropped forged
of cr.v.steel, fully
heat treated

※ Applicable
terminals:
1.25-5.5mm

※ Double-colour
handle ergo-shaped

ITEM NO.	SIZE	BOX(CTN/PCS)
B0144-06	150mm/6"	-/72
B0144-07	175mm/7"	-/60
B0144-08	200mm/8"	-/48

Heavy duty pipe wrench



- Jaws made from high carbon steel, heat treated.
- Selected cast iron handle vinyl dipped for comfort

ITEM NO.	SIZE	MAX. WORKING DIA.	BOX (CTN/PCS)
B0001-08	200mm/8"	Φ27mm	6/48
B0001-10	250mm/10"	Φ34mm	6/36
B0001-12	300mm/12"	Φ42mm	6/24
B0001-14	350mm/14"	Φ50mm	6/24
B0001-18	450mm/18"	Φ60mm	-/12
B0001-24	600mm/24"	Φ76mm	-/8
B0001-36	900mm/36"	Φ85mm	-/4
B0001-48	1200mm/48"	Φ110mm	-/2

Pipe wrench (aluminum handle)



- Jaws made of chrome vanadium steel heat treated.
- Aluminum handle for easier operation and added torque

ITEM NO.	SIZE	MAX. WORKING DIA.	BOX (CTN/PCS)
B0002-08	200mm/8"	Φ27mm	10/60
B0002-10	250mm/10"	Φ34mm	10/40
B0002-12	300mm/12"	Φ42mm	6/24
B0002-14	350mm/14"	Φ50mm	5/20
B0002-18	450mm/18"	Φ60mm	-/12
B0002-24	600mm/24"	Φ76mm	-/8
B0002-36	900mm/36"	Φ85mm	-/4
B0002-48	1200mm/48"	Φ110mm	-/2

Chain pipe wrench



ITEM NO.	SIZE	MAX. WORKING DIA.	BOX (CTN/PCS)
B0004-690	690mm	76mm/3"	-/4
B0004-900	900mm	100mm/4"	-/4
B0004-1000	1000mm	150mm/6"	-/2
B0004-1200	1200mm	200mm/8"	-/2
B0004-1400	1400mm	300mm/12"	-/2

Pump pliers



- Carbon steel drop forged & chrome plated

ITEM NO.	SIZE	BOX (CTN/PCS)
B0006-10	250mm/10"	6/48
B0006-12	300mm/12"	6/36

Pump pliers

CR-V.



- Chrome vanadium steel drop forged

ITEM NO.	SIZE	BOX (CTN/PCS)
B0007-10	250mm/10"	6/48

Slip joint pliers



A: Double colour vinyl dipped handle

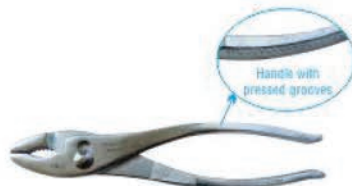

B: Bare handle with pressed grooves

ITEM NO.	SIZE	BOX (CTN/PCS)
B0008-06	150mm/6"	12/96
B0008A-08	200mm/8"	6/72
B0008B-08	200mm/8"	6/72
B0008-10	250mm/10"	6/48

Lineman's pliers

CR-V.



- Chrome vanadium steel drop forged.
- Fully hardened, cutting edges induction quenched

ITEM NO.	SIZE	BOX (CTN/PCS)
B0010-08	200mm/8"	6/48

Point-nosed pliers

CR-V.



- Chrome vanadium steel drop forged.
- Fully hardened, cutting edges induction quenched

ITEM NO.	SIZE	BOX (CTN/PCS)
B0011-06	150mm/6"	6/72

Diagonal cutting pliers

CR-V.



- Chrome vanadium steel drop forged.
- Fully hardened, cutting edges induction quenched

ITEM NO.	SIZE	BOX (CTN/PCS)
B0012-06	150mm/6"	6/72

Plastic cutting pliers

CR-V.



- Chrome vanadium steel drop forged & heat treated
- Spring loaded

ITEM NO.	SIZE	BOX (CTN/PCS)
B0013-05	125mm/5"	12/96
B0013-06	150mm/6"	12/96

Plastic cutting pliers

CR-V.



- Chrome vanadium steel drop forged & heat treated
- Spring loaded

ITEM NO.	SIZE	BOX (CTN/PCS)
B0131-05	125mm/5"	12/96
B0131-06	150mm/6"	12/96

Diagonal cutting pliers



- Chrome vanadium steel drop forged & heat treated
- Spring loaded

ITEM NO.	SIZE	BOX (CTN/PCS)
B0218-05	125mm/5"	12/108

Lineman's pliers



- Carbon steel drop forged steel with insulation sleeves

ITEM NO.	SIZE	BOX(CTN/PCS)
B0014-06	150mm/6"	6/72
B0014-07	175mm/7"	6/60
B0014-08	200mm/8"	6/48

Point-nosed pliers



- Carbon steel drop forged steel with insulation sleeves

ITEM NO.	SIZE	BOX(CTN/PCS)
B0015-06	150mm/6"	6/72
B0015-07	175mm/7"	6/60
B0015-08	200mm/8"	6/48

Diagonal cutting pliers



- Carbon steel drop forged steel with insulation sleeves

ITEM NO.	SIZE	BOX(CTN/PCS)
B0016-06	150mm/6"	6/72
B0016-07	175mm/7"	6/60
B0016-08	200mm/8"	6/48

Energy saving combination pliers



- Carbon steel drop forged steel with insulation sleeves

ITEM NO.	SIZE	BOX(CTN/PCS)
B0142-08	200mm/8"	6/48

Lineman's pliers Ni.Cr.coated



- Carbon steel drop forged steel with insulation sleeves

ITEM NO.	SIZE	BOX(CTN/PCS)
B0141-08	200mm/8"	6/48

Point-nosed pliers Ni.Cr.coated



- Carbon steel drop forged steel with insulation sleeves

ITEM NO.	SIZE	BOX(CTN/PCS)
B0151-06	150mm/6"	6/72

Diagonal cutting pliers Ni.Cr.coated



- Carbon steel drop forged steel with insulation sleeves

ITEM NO.	SIZE	BOX(CTN/PCS)
B0161-06	150mm/6"	6/72

Lineman's pliers EURO TYPE



- ※ Drop forged from high carbon steel.
- ※ Cutting edges induction hardened.
- ※ Plastic insulation sleeves

ITEM NO.	SIZE	BOX(CTN/PCS)
B0143-06	150mm/6"	12/72
B0143-07	175mm/7"	12/60
B0143-08	200mm/8"	12/48

Point-nosed pliers EURO TYPE



- ※ Drop forged from high carbon steel.
- ※ Cutting edges induction hardened.
- ※ Plastic insulation sleeves

ITEM NO.	SIZE	BOX(CTN/PCS)
B0153-06	150mm/6"	12/72
B0153-07	175mm/7"	12/60
B0153-08	200mm/8"	12/48

Diagonal cutting pliers EURO TYPE



- ※ Drop forged from high carbon steel.
- ※ Cutting edges induction hardened.
- ※ Plastic insulation sleeves

ITEM NO.	SIZE	BOX(CTN/PCS)
B0163-06	150mm/6"	12/72
B0163-07	175mm/7"	12/60
B0163-08	200mm/8"	12/48

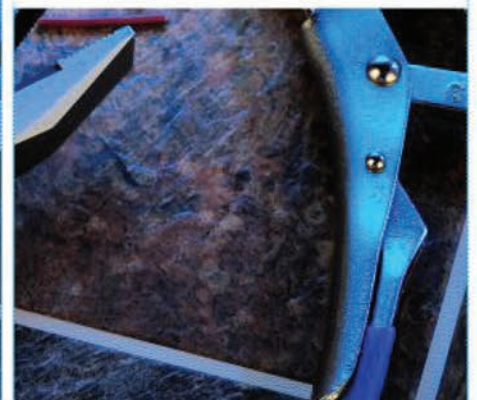

Heavy-duty combination pliers



- ※ Cutting capacity
Hard wire: Ø3.4mm
Soft wire: Ø4.0mm
- ※ Drop forged from high carbon steel.
- ※ Cutting edges induction hardened.
- ※ Plastic insulation sleeves

ITEM NO.	SIZE	BOX/CTN/PCS
B0019-10	250mm/10"	6/36

Point-nosed pliers



- Carbon steel drop forged & heat treated.
- Black nickel finish.
- Spring loaded.

ITEM NO.	SIZE	BOX/CTN/PCS
B0017-05	125mm/5"	12/96

Mini point nose pliers



- Carbon steel drop forged & heat treated.
- Black nickel finish.
- Spring loaded.

ITEM NO.	SIZE	BOX/CTN/PCS
B0171-05	135mm/5"	12/96

Mini flat nose pliers



- Carbon steel drop forged & heat treated.
- Black nickel finish.
- Spring loaded.

ITEM NO.	SIZE	BOX/CTN/PCS
B0172-05	130mm/5"	12/96

Mini bent nose pliers



- Carbon steel drop forged & heat treated.
- Black nickel finish.
- Spring loaded.

ITEM NO.	SIZE	BOX/CTN/PCS
B0173-05	130mm/5"	12/96

Diagonal cutting pliers



- Carbon steel drop forged & heat treated.
- Black nickel finish.
- Spring loaded.

ITEM NO.	SIZE	BOX/CTN/PCS
B0018-110	110mm	12/96

Mini combination pliers



- Carbon steel drop forged & heat treated.
- Black nickel finish.
- Spring loaded.

ITEM NO.	SIZE	BOX/CTN/PCS
B0181-05	125mm/5"	12/96

Mini end cutters



- Carbon steel drop forged & heat treated.
- Black nickel finish.
- Spring loaded.

ITEM NO.	SIZE	BOX/CTN/PCS
B0182-110	110mm	12/96

Circlip pliers set



- ※ High carbon steel, heat-treated.
- ※ Spring loaded for easier operation.
- ※ Plastic handle for comfort.
- ※ Always wear eye protection when using tools.
- ※ Effective range: 10-50mm 3/8"-2"

ITEM NO.	SIZE	BOX/CTN/PCS
B0026-07	175mm/7"	10/60

Circlip pliers-high carbon steel



- Drop forged and heat treated.
- Double colour vinyl handle spring loaded

ITEM NO.	SIZE	Specs.	BOX/CTN/PCS
B0022-05	125mm/5"	Ca. steel	12/96
B0022-07	175mm/7"	Ca. steel	12/96
B0022-09	225mm/9"	Ca. steel	12/72
B0022-13	325mm/13"	Ca. steel	-

Circlip pliers-high carbon steel



- Drop forged and heat treated.
- Double colour vinyl handle spring loaded

ITEM NO.	SIZE	Specs.	BOX/CTN/PCS
B0023-05	125mm/5"	Ca. steel	12/96
B0023-07	175mm/7"	Ca. steel	12/96
B0023-09	225mm/9"	Ca. steel	12/72
B0023-13	325mm/13"	Ca. steel	-

Circlip pliers-high carbon steel



- Drop forged and heat treated.
- Double colour vinyl handle spring loaded

ITEM NO.	SIZE	Specs.	BOX/CTN/PCS
B0024-05	125mm/5"	Ca. steel	12/96
B0024-07	175mm/7"	Ca. steel	12/96
B0024-09	225mm/9"	Ca. steel	12/72
B0024-13	325mm/13"	Ca. steel	-

Circlip pliers-high carbon steel



- Drop forged and heat treated.
- Double colour vinyl handle spring loaded

ITEM NO.	SIZE	Specs.	BOX/CTN/PCS
B0025-05	125mm/5"	Ca. steel	12/96
B0025-07	175mm/7"	Ca. steel	12/96
B0025-09	225mm/9"	Ca. steel	12/72
B0025-13	325mm/13"	Ca. steel	-

Round-nosed clamping pliers



- High carbon steel drop forged & heat treated.
- Black phosphated finish

ITEM NO.	SIZE	SIZE	BOX(CTN/PCS)
B0050-05-11	275mm/11"	5mm	6/54
B0050-10-11	275mm/11"	10mm	6/54
B0050-15-11	275mm/11"	15mm	6/54

Long-nosed pliers



- High carbon steel drop forged & heat treated.
- Black phosphated finish

ITEM NO.	SIZE	BOX(CTN/PCS)
B0051-11	275mm/11"	6/36

Bent-nosed pliers 45°



- High carbon steel drop forged & heat treated.
- Black phosphated finish

ITEM NO.	SIZE	BOX(CTN/PCS)
B0052-11	275mm/11"	6/36

Bent-nosed pliers 90°



- High carbon steel drop forged & heat treated.
- Black phosphated finish

ITEM NO.	SIZE	BOX(CTN/PCS)
B0053-11	275mm/11"	6/36

Walnut pliers and cutter CR-V



- Chrome vanadium steel drop forged and heat treated.
- Double colour vinyl dipped handle

ITEM NO.	SIZE	BOX(CTN/PCS)
B0027-08	200mm/8"	6/48

Automatic wire stripper



ITEM NO.	SIZE	BOX(CTN/PCS)
B0028	0.2-1.5m ²	8/48

Automatic wire stripper



- A 0.5-1.0-1.6-2.0mm
- B 0.5-1.2-1.6-2.0-2.6-3.2mm
- C 0.5-1.0-2.5-4.0-6.0mm²

Most widely used wire sizes

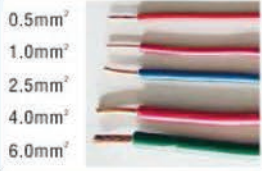

- ※ Blades made of carbon steel, heat treated.
- ※ All metal construction ensures durability and strength.
- ※ Awg size clearly marked at each cutting station.
- ※ Adjustable stripping length guide provides consistent uniform strip length.

ITEM NO.	SIZE	BOX(CTN/PCS)
B0029-A	0.5-1.0-1.6-2.0mm	8/48
B0029-B	0.5-1.2-1.6-2.0-2.6-3.2mm	8/48
B0029-C	0.5-1.0-2.5-4.0-6.0mm ²	8/48

Wire stripper & cutter



2 in 1, wire stripper & cutter
 Applicable wire stripper size: 0.5mm²-6mm²
 Adjustable stop for consistency in wire strip lengths
 Light, handy and excellent durability

ITEM NO.	SIZE	BOX(CTN/PCS)
B0030	0.5-6m ²	10/60

Wire stripping tool



B0342 A		B0342 B		B0342 C	
APPLICABLE AWG SIZES		APPLICABLE AWG SIZES		APPLICABLE AWG SIZES	
STANDED	SINGLE	STANDED	SINGLE	STANDED	SINGLE
24	22	28	26	32	30
22	20	26	24	30	28
20	18	24	22	28	26
18	16	22	20	26	24
16	14	20	18	24	22
14	12	18	16	22	20
12	10	16	14	20	18

B0342 A	B0342 B	B0342 C
---------	---------	---------

- Suitable for wire stripping and wire cutting

ITEM NO.	SIZE	BOX(CTN/PCS)
B0342-A	A 150mm/6"	12/72
B0342-B	B 150mm/6"	12/72
B0342-C	C 150mm/6"	12/72

Wire stripping tool



0.05-0.52mm²,
 0.2mm(30AWG), 0.3mm(28AWG), 0.4mm(26AWG)
 0.5MM(24AWG), 0.6mm(22AWG), 0.8mm(20AWG)



Carbon steel full



Wire stripping of various gauge sizes



Wire cutting capacity: 0.5-0.8MM



High carbon steel heat treated.
 Precision ground stripping holes for accurate performance



Spring-loaded handle for easy repeated action

ITEM NO.	SIZE	BOX(CTN/PCS)
B0342-D	0.2-0.8mm	12/72

Multi-function crimping tool

New model



- Suitable for crimping, Wire stripping and wire cutting

ITEM NO.	SIZE	BOX(CTN/PCS)
B0034	250mm/10'	8/64

Multi-function crimping tool

New model



- Suitable for crimping, Wire stripping and wire cutting

ITEM NO.	SIZE	BOX(CTN/PCS)
B0341	225mm/9'	8/64

Mudular plug crimping tool



- For crimping modular plugs, with wire cutter

ITEM NO.	SIZE	BOX(CTN/PCS)
B0032	8P 8C	12/72

Modular plug crimping tool



- For crimping computer and telephone plugs, with wire cutter

ITEM NO.	SIZE	BOX(CTN/PCS)
B0033	6P 8P	12/48

Modular plug crimping tool



- For crimping modular plugs 4 pins, 6 pins & 8 pins, with wire cutter

ITEM NO.	SIZE	BOX(CTN/PCS)
B0046	6P 8P 4P	6/36

Ratchet crimping tool



- For various kinds of terminals as shown below.
- Jaws interchangeable and replacable

編號	規格	盒箱 (支)
B0043-C	C	7/42
B0043-D	D	7/42
B0043-E	E	7/42
B0043-G	G	7/42
B0043-H	H	7/42
B0043-H1	H1	7/42
B0043-I	I	7/42
B0043-J	J	7/42
B0043-M	M	7/42
B0043-N	N	7/42
B0043-W	W	7/42

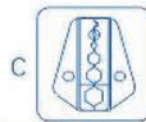

Applicable range	Description
.256" .319" .068" .213" (6.50/8.10/1.72/5.41mm)	RG 58, 59, 62, 6



Applicable range	Description
.213" .256" .068" .324" (5.41/6.50/1.72/8.23mm)	RG 58, 59, 62, 6



Applicable range	Description
AWG 10 8 6 DIN 6 10 16mm'	PIN TERMINAL INSULATED OR NON-INSULATED FERRULES

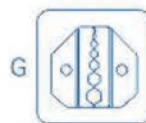

Applicable range	Description
.043" .068" .100" .137" .213" .256" (1.09/1.72/2.54/3.48/5.41/6.48mm)	RG 58, 59, 62, 174 Fiber Optic

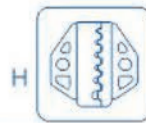

Applicable range	Description
AWG 22 10 18 16 14 12 DIN 0.5-0.75 1.0 1.5 2.5 4.0mm'	PIN TERMINAL INSULATED OR NON-INSULATED FERRULES

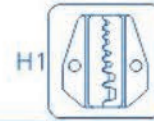

Applicable range	Description
AWG 22-20 18-16 14 12 10 DIN 0.5-0.75 1.0-1.5 2.5 4.0 6.0mm'	PIN TERMINAL INSULATED OR NON-INSULATED FERRULES

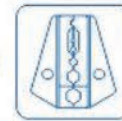

Applicable range	Description
.255" .213" .100" .068" .324" (6.48/5.41/2.54/1.72/8.23mm)	RG 58, 59, 62, 6

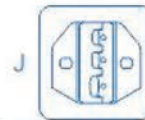

Applicable range	Description
AWG 22-18 16-14 12-10 DIN 0.5-1.0 1.5-2.5 4-6mm'	FOR INSULATED TERMINAL



Applicable range	Description
AWG 20-18 16-14 12-10 DIN 1.5 2.5 6mm' JIS 1.25 2.0 5.5mm'	INTER-LOCKING & NON-INSULATED

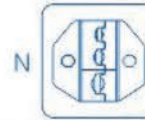

Applicable range	Description
AWG 20-18 16-14 12-10 6 DIN 1.5 2.5 6 10mm' JIS 1.25 2.0 5.5 8mm'	NON-INSULATED TERMINAL

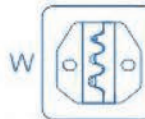

Applicable range	Description
AWG 22-18 16-14 12-10 DIN 0.5-1.0 1.5-2.5 4-6 mm' JIS 1.25 2.0 5.5mm'	VINYL INSULATED W/O COPPER SLEEVE

Crimping tool



- For non-insulated terminals with wire cutter

ITEM NO.	SIZE	BOX(CTN/PCS)
B0042	180mm/7'	12/72

Self-adjusting crimping pliers



B0049-0604
0.25-10mm²

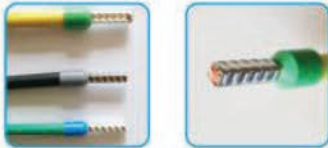

Quadrilateral type

B0049-0606
0.25-6mm²

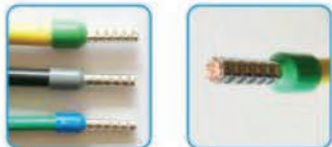

Hexagon type



ITEM NO.	SIZE	BOX(CTN/PCS)
B0049-0604	0.25-16mm ² AWG23-5	
B0049-0606	0.25-10mm ² AWG23-7	

Lock-grip pliers



- Chrome vanadium steel drop forged
- Curved jaws with wire cutters.
- Nickel plated

ITEM NO.	SIZE	BOX(CTN/PCS)
B0035-07	175mm/7"	6/54
B0035-10	250mm/10"	6/36

Lock-grip pliers



Milled teeth for positive grip
High carbon steel drop forged and heat treated with wire cutter
Hardened tension bar with toggle mechanism provides secure locking action

ITEM NO.	SIZE	BOX(CTN/PCS)
B0351-10	250mm/10"	6/36

Lock-grip pliers



- Chrome vanadium steel drop forged
- Curved jaws with wire cutters.
- Nickel plated

ITEM NO.	SIZE	BOX(CTN/PCS)
B0036-10	250mm/10"	6/36

Lock-grip pliers



- Chrome vanadium steel drop forged
- Curved jaws with wire cutters.
- Nickel plated

ITEM NO.	SIZE	BOX(CTN/PCS)
B0037-06	165mm/6"	6/72

Lock-grip pliers



- Chrome vanadium steel drop forged
- Nickel plated

ITEM NO.	SIZE	BOX(CTN/PCS)
B0038-R	Regular 275mm/11"	4/24
B0038-SP	Swivel pads 275mm/11"	4/24

Locking chain clamp



- Chrome vanadium steel drop forged
- Length of chain can be adjusted when needed

ITEM NO.	SIZE	BOX(CTN/PCS)
B0039-18	450mm/18"	6/24

2-jaw gear pullers



CR.V. STEEL

ITEM NO.	SIZE	BOX(CTN/PCS)
B0040-03	75mm/3"	1/20
B0040-04	100mm/4"	1/20
B0040-06	150mm/6"	1/12
B0040-08	200mm/8"	1/5
B0040-10	250mm/10"	1/4
B0040-12	300mm/12"	1/2

3-jaw gear pullers



CR.V. STEEL

ITEM NO.	SIZE	BOX(CTN/PCS)
B0041-03	75mm/3"	1/20
B0041-04	100mm/4"	1/20
B0041-06	150mm/6"	1/10
B0041-08	200mm/8"	1/4
B0041-10	250mm/10"	1/4
B0041-12	300mm/12"	-/1

2-jaw gear pullers



HIGH CARBON STEEL

ITEM NO.	SIZE	BOX(CTN/PCS)
B0040A-10	250mm/10"	1/4
B0040A-12	300mm/12"	1/2

3-jaw gear pullers



NEW!

HIGH CARBON STEEL

ITEM NO.	SIZE	BOX(CTN/PCS)
B0041A-10	250mm/10"	1/4
B0041A-12	300mm/12"	1/2

Gear puller-adjustable arms



- Jaws made of chrome vanadium steel.
- Jaws can be set inward or outward

ITEM NO.	SIZE	BOX(CTN/PCS)
B0045-01	1#(80*100)	1/20
B0045-02	2#(120*100)	1/20
B0045-03	3#(150*150)	1/10
B0045-04	4#(200*150)	1/6
B0045-05	5#(250*200)	1/4

Heavy duty bench vise

PRECISION CASTING BODY
POWDER COATING FINISH

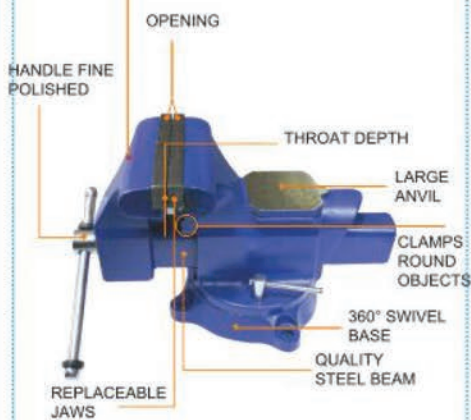

ITEM NO.	SIZE	BOX(CTN/PCS)
L0058-04	100mm/4"	-/2
L0058-05	125mm/5"	-/1
L0058-06	150mm/6"	-/1
L0058-08	200mm/8"	-/1

Pilot bearing puller



B0047 [S0018]

ITEM NO.	SIZE	BOX(CTN/PCS)
B0047	12-38mm	1/20

Bearing & shaft sleeve puller



1. Especially designed to dismount (pull out) bearing or shaft sleeve
2. Thin wall hooks to hold workpiece firmly
3. Long adjustable arms to reach to otherwise hard-to get areas
4. Drop forged from cr.v. Steel, heat treated
5. Applicable bearing size: $\varnothing 19-35\text{mm}$

ITEM NO.	SIZE	BOX(CTN/PCS)
B0048-1#	19-35mm	-
B0048-2#	24-55mm	-
B0048-3#	35-80mm	-

Hollow punch pliers



- Elliptical: 7x5mm
- Round: 3.5, 4.0, 4.5mm
- Long square: 7x3.5mm, 8x4mm

ITEM NO.	SIZE	BOX(CTN/PCS)
B0441		6/48

BLADE REPLACEABLE PATENTED PUNCH TOOL

Constructed with heat-treated metal sheet for long time heavy-duty punching.



Our patented blade replacing mechanism greatly prolongs the lifetime of our pliers.



Alloy steel blade uniquely treated and sharpened makes your punch easy and clean

ITEM NO.	SIZE	BOX(CTN/PCS)
B0044	2.0 2.5 3.0 3.5 4.0 4.5mm	6/48

Heavy duty hollow punch blades



ITEM NO.	SIZE	BOX(CTN/PCS)
B0044B		5/-
B00441B		5/-

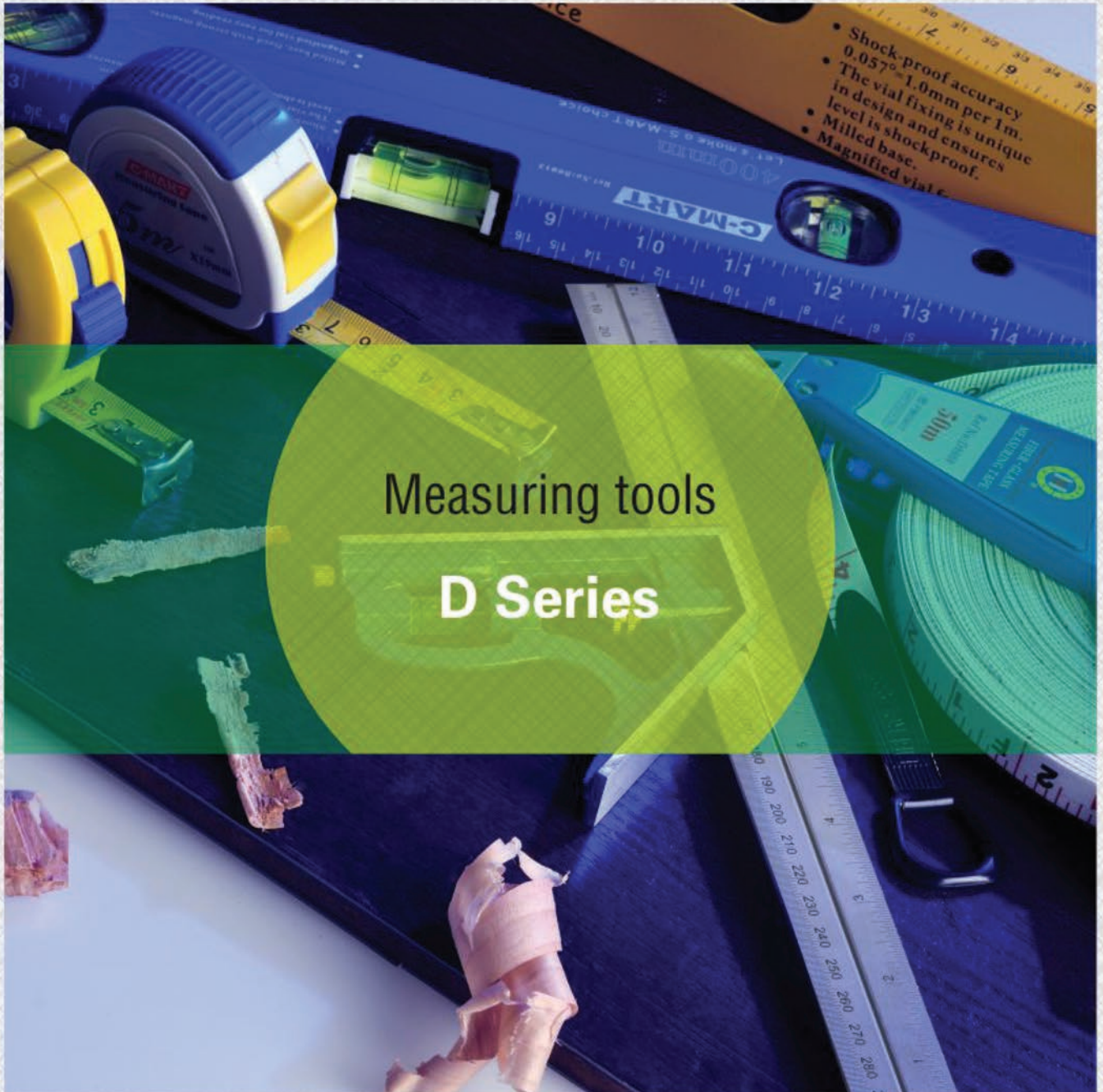

Measuring tools
D Series

TAIWAN C-MART PRACTICAL TOOLS CO., LTD. / SHANGHAI C-MART TOOLS CO., LTD.

Measuring tape



ITEM NO.	SIZE	BOX(CTN/PCS)
D0002-212.5	MM & inch Metric 2*12.5mm	12/288
D0002-213	MM & inch Metric 2m*13mm	12/288
D0002-312.5	MM & inch Metric 3*12.5mm	12/240
D0002-316	MM & inch Metric 3m*16mm	12/240
D0002-3.516	MM & inch Metric 3.5m*16mm	12/144
D0002-519	MM & inch Metric 5m*19mm	12/120
D0002-5.519	MM & inch Metric 5.5*19mm	12/120
D0002-525	MM & inch Metric 5m*25mm	10/100
D0002-5.525	MM & inch Metric 5.5*25mm	10/100
D0002-7.525	MM & inch Metric 7.5m*25mm	6/60
D0002-825	MM & inch Metric 8*25mm	6/60
D0002-1025	MM & inch Metric 10*25mm	6/60

Measuring tape



- Double layer resin coating protects blade from rust and corrosion.
- Triple-riveted end hook with bottom blade protector.
- Built-in shock absorber to protect blade tip.
- Thick high carbon steel blade insures a strong blade extension.
- Plastic case with rubber cover for comfort.

ITEM NO.	SIZE	BOX(CTN/PCS)
D0004-216	MM & inch Metric 2m*13mm	12/72
D0004-316	MM & inch Metric 3m*16mm	12/72
D0004-3.516	MM & inch Metric 3.5m*16mm	12/72
D0004-519	MM & inch Metric 5m*19mm	10/120
D0004-7.525	MM & inch Metric 7.5m*25mm	12/48

Measuring tape



ITEM NO.	SIZE	BOX(CTN/PCS)
D0007-316	MM & inch Metric 3m*16mm	
D0007-519	MM & inch Metric 5m*19mm	
D0007-525	MM & inch Metric 5m*25mm	
D0007-7.525	MM & inch Metric 7.5m*25mm	

Steel measuring tape



ITEM NO.	SIZE	BOX(CTN/PCS)
D0005-519-GY	Fengshui Tape 5*19mm	12/120
D0005-7.525-GY	Fengshui Tape 7.5*25mm	6/60
D0005-1025-GY	Fengshui Tape 10*25mm	6/48
D0005-519-LB	Luban tape 5*19mm	12/120
D0005-7.525-LB	Luban tape 7.5*25mm	6/60
D0005-1025-LB	Luban tape 10*25mm	6/48

Fiber-glass measuring tape



- Double colour plastic case.
- High quality fibre-glass tape.
- Both metric , metric & S.A.E. combined graduations available

ITEM NO.	SIZE	BOX(CTN/PCS)
D0008-30	30m	1/20
D0008-50	50m	1/20

Measuring tape



- Double layer resin coated steel tape.
- Both metric , metric & S.A.E. combined graduations available

ITEM NO.	SIZE	BOX(CTN/PCS)
D0009-10	10m	6/60
D0009-20	20m	6/48
D0009-30	30m	6/36

Torpedo spirit level



- Impact-resistant plastic with aluminum lining.
- Three quality vials.
- Magnetic base

ITEM NO.	SIZE	BOX(CTN/PCS)
D0011-09	225mm/9"	12/96

Mini spirit level



- Impact-resistant plastic with aluminum lining.
- Two quality vials.
- Magnetic base
- Compact size easy to carry

ITEM NO.	SIZE	BOX(CTN/PCS)
D0012-04	100mm/4"	12/96

Aluminium spirit level



- ※ 3 fixed acrylic vials with professional accuracy
- ※ Accuracy 0.5mm/m
- ※ Soft rubber end covers for shock absorption
- ※ 0.8mm high quality profile

ITEM NO.	SIZE	BOX(CTN/PCS)
D0010-12	300mm/12"	-/50
D0010-16	400mm/16"	-/50
D0010-20	500mm/20"	-/50
D0010-24	600mm/24"	-/50
D0010-32	800mm/32"	-/30
D0010-40	1000mm/40"	-/30
D0010-48	1200mm/48"	-/20
D0010-60	1500mm/60"	-/20
D0010-72	1800mm/72"	-/20

Aluminium spirit level



- Thick aluminum construction insures long time steady performance.
- Three quality vials for multi-purpose measuring.
- Strong magnet installed.
- High level of accuracy guaranteed

ITEM NO.	SIZE	BOX(CTN/PCS)
D0013-12	300mm/12"	-/50
D0013-16	400mm/16"	-/50
D0013-20	500mm/20"	-/50
D0013-24	600mm/24"	-/50
D0013-32	800mm/32"	-/30
D0013-40	1000mm/40"	-/30
D0013-48	1200mm/48"	-/20
D0013-60	1500mm/60"	-/20
D0013-72	1800mm/72"	-/20

Aluminium spirit level



- Thick aluminum construction insures long time steady performance.
- Three quality vials for multi-purpose measuring.
- High level of accuracy guaranteed

ITEM NO.	SIZE	BOX(CTN/PCS)
D0014-12	300mm/12"	-/50
D0014-16	400mm/16"	-/50
D0014-20	500mm/20"	-/50
D0014-24	600mm/24"	-/30
D0014-32	800mm/32"	-/30
D0014-40	1000mm/40"	-/20
D0014-48	1200mm/48"	-/20
D0014-60	1500mm/60"	-/20
D0014-72	1800mm/72"	-/20

Aluminium try square

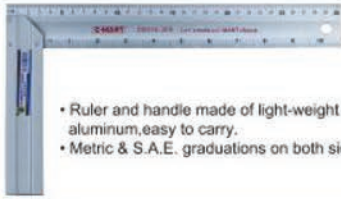

- Ruler and handle made of light-weight aluminum, easy to carry.
- Metric & S.A.E. graduations on both sides

ITEM NO.	SIZE	BOX(CTN/PCS)
D0015-250	250mm	12/96
D0015-300	300mm	12/96
D0015-500	500mm	6/48

Combination try square stainless steel



- Stainless steel ruler with metric and S.A.E. markings on both sides.
- Aluminum handle with level vial.
- Four ways of measuring as shown below.



ITEM NO.	SIZE	BOX(CTN/PCS)
D0016-12	300mm/12"	12/72

Aluminium try square

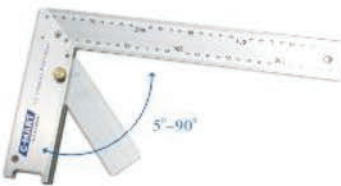

- Stainless steel ruler, aluminum handle.
- Adjustable angle-finder stored in handle
- for multi-angle measuring

ITEM NO.	SIZE	BOX(CTN/PCS)
D0017-12	300mm/12"	6/48

Thickness gauge



ITEM NO.	SIZE	BOX(CTN/PCS)
D0018-15	0.05mm-0.63mm	12/-
D0018-26	0.03mm-0.63mm	12/-
D0018-31	0.04mm-0.88mm	12/-

Stainless steel ruler



- Stainless steel.
- Metric graduation on one side, conversion table on the other

ITEM NO.	SIZE	BOX(CTN/PCS)
D0019-150	150mm	12/1200
D0019-300	300mm	10/300
D0019-500	500mm	10/100
D0019-600	600mm	10/100
D0019-1000	1000mm	10/40

Stainless steel protractor



- Stainless steel.
- Multi-angle measuring

ITEM NO.	SIZE	BOX(CTN/PCS)
D0023		10/100

Stainless steel protractor

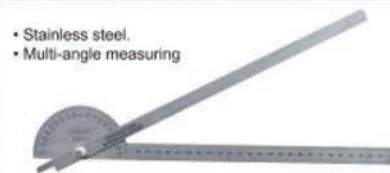

- Stainless steel.
- Multi-angle measuring

ITEM NO.	SIZE	BOX(CTN/PCS)
D0025		10/100

Vernier caliper with metric or inch scale



- Made of stainless steel heat-treated.
- Used for outside, inside, depth and steps measurement.

ITEM NO.	SIZE	BOX(CTN/PCS)
D0020-06-QG	Metric 0-150mm	1/50
D0020-06-GY	MM & inch 0-150mm	1/50
D0020-08-QG	Metric 0-200mm	1/50
D0020-08-GY	MM & inch 0-200mm	1/50

Vernier caliper



- Made of carbon steel heat-treated.
- Used for outside, inside, depth and steps measurement.

ITEM NO.	SIZE	BOX(CTN/PCS)
D0201-06	0-150mm	1/50
D0201-08	0-200mm	

Electronic digital caliper



- Stainless steel ruler.
- Zinc alloy digital display case.
- Used for outside, inside, depth and steps measurement.
- Metric/inch interchangeable

ITEM NO.	SIZE	BOX(CTN/PCS)
D0021-06	0-150mm	1/50
D0021-08	0-200mm	1/50

Electronic digital caliper



- Stainless steel ruler.
- Plastic digital display case.
- Used for outside, inside, depth and steps measurement.
- Metric/inch interchangeable

ITEM NO.	SIZE	BOX(CTN/PCS)
D0022-06	0-150mm	1/50
D0022-08	0-200mm	1/50

Dial calipers (close frame type)



- Stainless steel ruler.
- Large screen dial for easy reading
- Used for outside, inside, depth and steps measurement.

ITEM NO.	SIZE	BOX(CTN/PCS)
D0024-06	0-150mm	1/50

Dial calipers close frame type



- Metric/inch and only metric scale (marking) selectable.
- With a fixed scale and a sliding scale.
- With fastening screw.
- Made of high carbon steel chrome plated.

ITEM NO.	SIZE	BOX(CTN/PCS)
D0027-06	0-150mm	1/50
D0027-08	0-200mm	

Outside micrometer



- Graduation metric 0.01mm inch 0.0001"
- Spindle lock, with zero adjusting wrench, carbide tipped

ITEM NO.	SIZE	BOX(CTN/PCS)
D0026-025	0-25mm	10/50
D0026-2550	25-50mm	10/50
D0026-5075	50-75mm	10/50

Digital distance measuring wheel

- ※ Wheel made of impact ABS covered with wear resistant rubber ring
- ※ Large LCD Digital Display
- ※ 3-section aluminum handle makes it easy to put the tool in your backpack
- ※ Dust and water proof buttons
- ※ Metric and inch selectable with memory function
- ※ Blu-ray display readable at night
- ※ Metal side stand



D0031



NEW!



Max measuring range: 10000 metres or 9999.9米
 Accuracy: +/-0.5%
 Minimum reading: 0.1m
 Power supply: 1.5V (2X "AAA" batteries)
 Suitable temperature for use: -10°C-45°C

ITEM NO.	SIZE	BOX(CTN/PCS)
D0031		

Distance measuring wheel

- ※ Wheel made of impact ABS covered with wear resistant rubber ring
- ※ Ratchet gear-driven counter moves forward to increase count and moves backward to decrease count, with reset button
- ※ Telescopic aluminum handle with ergo-shaped dual-colored grip
- ※ Retractable metal stand



D0032



NEW!



Max range: 99999.9米
 Accuracy: +/-0.5%
 Minimum reading: 0.1m
 Suitable temperature: -10°C-45°C
 Diameter of the wheel: 318mm/12.5"
 Measuring unit: Meter

ITEM NO.	SIZE	BOX(CTN/PCS)
D0032		



Knife-shaped steel wire brush



- Hardened steel wires twisted and brass plated.
- Ergo-shaped plastic handle

ITEM NO.	SIZE	BOX(CTN/PCS)
E0001-10	250mm/10"	12/120

Grinding wheel-for metal



- For cleaning and polishing metal

ITEM NO.	SIZE	BOX(CTN/PCS)
E0003	100mm/4"	20/200

Flap discs



- For cleaning and polishing metal and wood

ITEM NO.	SIZE	BOX(CTN/PCS)
E0005-40	100*16mm/#40	10/240
E0005-60	100*16mm/#60	10/240
E0005-80	100*16mm/#80	10/240
E0005-100	100*16mm/#100	10/240
E0005-120	100*16mm/#120	10/240
E0005-150	100*16mm/#150	10/240
E0005-180	100*16mm/#180	10/240
E0005-220	100*16mm/#220	10/240
E0005-240	100*16mm/#240	10/240
E0005-280	100*16mm/#280	10/240
E0005-320	100*16mm/#320	10/240
E0005-360	100*16mm/#360	10/240
E0005-400	100*16mm/#400	10/240

5-pc high carbon steel file set



- 1-8" half-round file
- 1-8" triangle file
- 1-8" flat file bastard
- 1-8" round file
- 1-8" flat file second cut

ITEM NO.	SIZE	BOX(CTN/SET)
E0013	200mm/8"	5/20

5-pc needle file set



- High carbon steel heat treated

ITEM NO.	SIZE	BOX(CTN/SET)
E0015-5180	5*180mm	10/100

10-pc needle file set



- High carbon steel heat treated

ITEM NO.	SIZE	BOX(CTN/SET)
E0016-5180	5*180mm	12/120
E0016-3140	3*140mm	12/120
E0016-4160	4*160mm	12/120

High carbon steel file

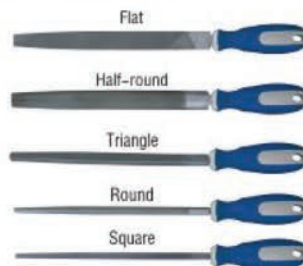

- High carbon steel heat treated

ITEM NO.	SIZE	BOX(CTN/PCS)
E0014-W-06	Round 150mm/6"	12/72
E0014-W-08	Round 200mm/8"	12/72
E0014-W-10	Round 250mm/10"	6/36
E0014-W-12	Round 300mm/12"	6/36
E0014-W-14	Round 350mm/14"	6/36
E0014-SJ-06	Triangle 150mm/6"	12/72
E0014-SJ-08	Triangle 200mm/8"	12/72
E0014-SJ-10	Triangle 250mm/10"	6/36
E0014-SJ-12	Triangle 300mm/12"	6/36
E0014-SJ-14	Triangle 350mm/14"	6/36
E0014-BW-06	Half-round 150mm/6"	12/72
E0014-BW-08	Half-round 200mm/8"	12/72
E0014-BW-10	Half-round 250mm/10"	6/36
E0014-BW-12	Half-round 300mm/12"	6/36
E0014-BW-14	Half-round 350mm/14"	6/36
E0014-P-06	Flat 150mm/6"	12/72
E0014-P-08	Flat 200mm/8"	12/72
E0014-P-10	Flat 250mm/10"	6/36
E0014-P-12	Flat 300mm/12"	6/36
E0014-P-14	Flat 350mm/14"	6/36
E0014-F-06	Square 150mm/6"	12/72
E0014-F-08	Square 200mm/8"	12/72
E0014-F-10	Square 250mm/10"	6/36
E0014-F-12	Square 300mm/12"	6/36
E0014-F-14	Square 350mm/14"	6/36

Combination sharpening stone



- Aluminum oxide.
- Grit one side:100# Grit the other side:240#

ITEM NO.	SIZE	BOX(CTN/PCS)
E0026-06	150mm/6"	1/50
E0026-08	200mm/8"	1/30

Brick-laying trowels



- High carbon steel polished and heat treated.
- Double colour plastic handle

ITEM NO.	SIZE	BOX(CTN/PCS)
E0027-05	125mm/5"	1/120
E0027-06	150mm/6"	1/120
E0027-07	175mm/7"	1/120
E0027-08	200mm/8"	1/120
E0027-09	225mm/9"	

Plastering trowels



- High carbon steel polished and heat treated.
- Double colour plastic handle

ITEM NO.	SIZE	BOX(CTN/PCS)
E0028	200mm/8"	1/60

Dry grinding abrasive paper



ITEM NO.	SIZE	BOX(CTN/PCS)
E0031	40#-800#	-/1000

Abrasive paper



ITEM NO.	SIZE	BOX(CTN/PCS)
E0032	40#-800#	-/1000



Gardening tools
A Series2

TAIWAN C-MART PRACTICAL TOOLS CO., LTD. / SHANGHAI C-MART TOOLS CO., LTD.

Tree pruners

- Three-section telescopic aluminum handle.
- String-controlled cutter for pruning work at out-of-reach places.
- Cutter and saw made of high carbon steel heat treated

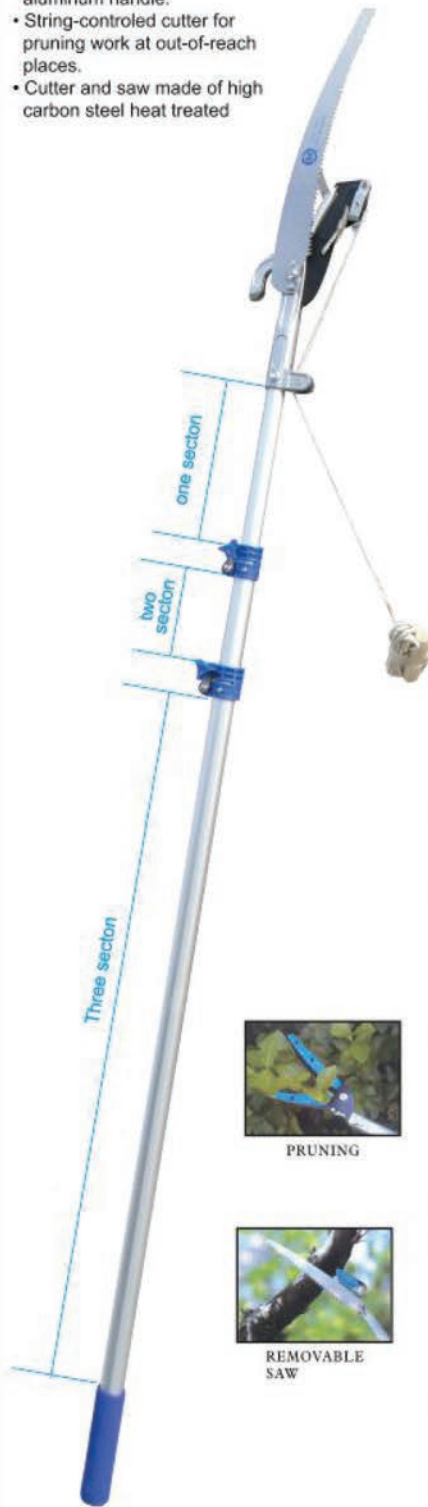

ITEM NO.	SIZE	BOX(CTN/PCS)
A0681-3	3m	-/12
A0681-5	5m	-/12

Pruning shears

SK5



- Press-to-open auto lock.
- Vinyl-dipped aluminum handle.
- Special-treated Sk5 blade insures long time performance.
- Cutting capacity: fresh wood dia.20mm, dry wood dia.12mm

ITEM NO.	SIZE	BOX(CTN/PCS)
A0045-08	200mm/8"	12/72

Pruning shears (aluminium handle)



- Ratchet construction allows easy operation for heavy-duty pruning work
- Rubber grip aluminum handle.
- Special-treated Sk5 blade insures long time performance.
- Cutting capacity: fresh wood dia.25mm, dry wood dia.18mm

ITEM NO.	SIZE	BOX(CTN/PCS)
A0046-08	200mm/8"	6/48

Multi-function shears aluminium handle



- Stainless steel blades hardened.
- Aluminum handle vinyl-dipped.
- For bonsai, kitchen, leather, hobby and fruit & vegetable harvesting

ITEM NO.	SIZE	BOX(CTN/PCS)
A0047-08	200mm/8"	6/48
A0047-09	225mm/9"	6/48

Pruning shears (plastic handle)



- Rubber-wrapped plastic handle.
- Stainless steel blades hardened
- Cutting capacity: fresh wood dia.12mm, dry wood dia.8mm

ITEM NO.	SIZE	BOX(CTN/PCS)
A0050-08	200mm/8"	12/96

Multi-function shears-GERMAN TYPE



- Sk5 steel blade, strong chrome-plated steel handle
- Blade hardness: hrc: 58-60°.
- Most suitable for cutting herbal medicine, rattan, wiring duct and branches
- Warning: protect your hands-wear gloves.

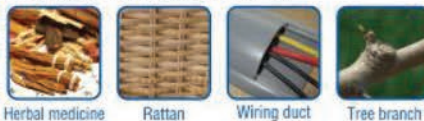

ITEM NO.	SIZE	BOX(CTN/PCS)
A0052-08	200mm/8"	12/70

Multi-purpose scissors



- Materials: stainless steel blades; plastic handle.
- Blade hardness: hrc: 54-56.
- Most suitable for the following applications



ITEM NO.	SIZE	BOX(CTN/PCS)
A0471	200mm/8"	12/96

Pruning shears zing alloy handle, aluminum handle



- High carbon steel heat treated.
- Zinc alloy handle and aluminum handle available
- Cutting capacity: fresh wood dia.15mm, dry wood dia.10mm

ITEM NO.	SIZE	BOX(CTN/PCS)
A0053-07	175mm/7"	12/72
A0053-08	200mm/8"	12/72
A0053-09	225mm/9"	12/72

Multi-purpose scissors



- Stainless steel blades hardened
- Double-color plastic handle
- For home, hobby, industry and garden use
- Cutting capacity: fresh wood dia. 8mm, dry wood dia. 4mm



KAVLAR WIRE CUTTING



KEVLAR FABRIC CUTTING



PRUNING, FRUIT & VEGETABLE PICKING



COTTON & SYNTHETIC FABRIC CUTTING



LEATHER CUTTING



KITCHEN USE



PVC WIRE CASING CUTTING



HEMP ROPE & NET ROPE CUTTING



WIRE CUTTING

ITEM NO.	SIZE	BOX(CTN/PCS)
A0054-08	200mm/8"	12/96

Pruning shears



- Stainless steel blades hardened
- Zinc alloy handle and aluminum handle available
- For home, hobby, industry and garden use
- Cutting capacity: fresh wood dia. 10mm, dry wood dia. 6mm

ITEM NO.	SIZE	BOX(CTN/PCS)
A0541-07	175mm/7"	12/96
A0541-08	200mm/8"	12/72

Thinning shears



- Stainless steel blades hardened
- Metal handle plastic-dipped.
- For thinning and trimming work

ITEM NO.	SIZE	BOX(CTN/PCS)
A0542-07	190mm/7"	12/96

Pruning shears (metal handle)

SK5



- Vinyl-dipped metal handle.
- Special-treated SK5 blade insures long time performance.
- Cutting capacity: fresh wood dia. 20mm, dry wood dia. 12

ITEM NO.	SIZE	BOX(CTN/PCS)
A0055-08	200mm/8"	12/72

Pruning shears (zinc alloy handle)

SK5



- Fish-skin zinc alloy handle for firm grip
- Special-treated SK5 blade insures long time performance.
- Cutting capacity: fresh wood dia. 20mm, dry wood dia. 12

ITEM NO.	SIZE	BOX(CTN/PCS)
A0056-07	175mm/7"	12/96
A0056-08	200mm/8"	12/72

Multi-function scissors



- Stainless steel blades heat treated.
- Sand-blast finish.
- Double-colour plastic handle.
- Used for cutting branches, vegetables, wires and thin metal sheet

ITEM NO.	SIZE	BOX(CTN/PCS)
A0059-07	175mm/7"	12/72
A0059-08	200mm/8"	12/72

Pruning shears (metal handle)

SK5



ITEM NO.	SIZE	BOX(CTN/PCS)
A0511-08	200mm/8"	12/72

Hedge shears



- Carbon steel heat-treated, Steel pipe handle with plastic grip
- Blade length: 250mm/10"
- Overall length: 560mm

ITEM NO.	SIZE	BOX(CTN/PCS)
A0061	275mm/11"	-/12

Hedge shears



- Carbon steel heat-treated, Steel pipe handle with plastic grip
- Blade length: 250mm/10"
- Overall length: 560mm

ITEM NO.	SIZE	BOX(CTN/PCS)
A0062	275mm/11"	-/12

Hedge shears



- Stainless steel heat-treated, aluminum forged handle with plastic grip
- Blade length: 250mm/10"
- Overall length: 600mm

ITEM NO.	SIZE	BOX(CTN/PCS)
A0063	225mm/9"	-/12

Hedge shears (telescopic metal handle)



- Carbon steel heat-treated, telescopic aluminum pipe handle with plastic grip
- Blade length: 250mm/10"
- Overall length: 570mm-860mm

ITEM NO.	SIZE	BOX(CTN/PCS)
A0064	250mm/10"	-/12

Hedge shears (metal handle)



- Carbon steel heat-treated, Steel pipe handle with plastic grip
- Blade length: 250mm/10"
- Overall length: 560mm

ITEM NO.	SIZE	BOX(CTN/PCS)
A0066	250mm/10"	-/12

Hedge shears (telescopic metal handle)



- Carbon steel heat-treated, telescopic steel pipe handle with plastic grip
- Blade length: 250mm/10"
- Overall length: 570mm-860mm

ITEM NO.	SIZE	BOX(CTN/PCS)
A0067	250mm/10"	-/12

Lopping shears aluminum handle



- High carbon steel heat-treated, aluminum pipe handle with plastic grip
- Blade length: 125mm/5"
- Overall length: 680mm
- Max. cutting capacity: fresh wood dia. 35mm, hard wood dia. 25mm

ITEM NO.	SIZE	BOX(CTN/PCS)
A0168	120mm/5"	-/12



Lopping shears telescopic aluminum handle



- High carbon steel heat-treated, telescopic aluminum pipe handle with plastic grip
- Blade length: 125mm/5"
- Overall length: 710mm-1100mm
- Max. cutting capacity: fresh wood dia. 35mm, hard wood dia. 25mm

ITEM NO.	SIZE	BOX(CTN/PCS)
A0368	710mm/1100mm	-/12

Camping shovel



ITEM NO.	SIZE	BOX(CTN/PCS)
A0702	630mm	-/6

Stainless steel shovel



ITEM NO.	SIZE	BOX(CTN/PCS)
A0703	820mm	-/12

Pointed / square Shovel-High Carbon Steel



ITEM NO.	SIZE	BOX(CTN/PCS)
A0704P	230x270x470x1020mm	-/12
A0704S	230x270x470x1020mm	-/12

Metal shovel



ITEM NO.	SIZE	BOX(CTN/PCS)
A0706		12/72

Cultihoe



ITEM NO.	SIZE	BOX(CTN/PCS)
A0707		10/40

Stainless mini shovel (wide) Wooden handle



ITEM NO.	SIZE	BOX(CTN/PCS)
A0708		12/-

Stainless mini shovel (narrow) Wooden handle



ITEM NO.	SIZE	BOX(CTN/PCS)
A0709		12/-

Mini steel rake



- Carbon steel heat-treated,
- Hard wood handle

ITEM NO.	SIZE	BOX(CTN/PCS)
A0694		6/24

Mini steel hoe



- Carbon steel heat-treated.
- Hard wood handle

ITEM NO.	SIZE	BOX(CTN/PCS)
A0695	Ca. steel	6/24

Two-way pick-hoe



- Carbon steel heat-treated.
- Hard wood handle

ITEM NO.	SIZE	BOX(CTN/PCS)
A0696	Ca. steel	6/24

Two-way rake/hoe



- Carbon steel heat-treated.
- Hard wood handle

ITEM NO.	SIZE	BOX(CTN/PCS)
A0697	Ca. steel	6/24

Hatchet



- Carbon steel heat treated.
- Hard wood handle

ITEM NO.	SIZE	BOX(CTN/PCS)
A0698	375mm/14"	-/24

Hatchet



- Carbon steel heat treated.
- Hard wood handle

ITEM NO.	SIZE	BOX(CTN/PCS)
A0699	400mm/16"	-/24

Utility saw



- High carbon steel heat treated.
- Ground teeth with triple-side cutting edges insures long-time and easy operation.
- Saw blades replaceable

ITEM NO.	SIZE	BOX(CTN/PCS)
A0192-210	210mm	6/24
A0192-240	240mm	6/24
A0192-270	270mm	6/24
A0192-300	300mm	6/24
A0192-350	350mm	6/24

Utility folding saw



- High carbon steel heat treated.
- Ground teeth with triple-side cutting edges insures long-time and easy operation.
- Saw blades replaceable

ITEM NO.	SIZE	BOX(CTN/PCS)
A0292-180	180mm	6/36
A0292-210	210mm	6/36
A0292-240	240mm	6/36
A0292-270	270mm	6/36

Utility saw blade



- High carbon steel heat treated.
- Ground teeth with triple-side cutting edges insures long-time and easy operation.
- Saw blades replaceable

ITEM NO.	SIZE	BOX(CTN/PCS)
A0192B-210	210mm	60/240
A0192B-240	240mm	60/240
A0192B-270	270mm	60/240
A0192B-300	300mm	60/240
A0292B-180	180mm	60/240
A0292B-210	210mm	60/240
A0292B-240	240mm	60/240
A0292B-270	270mm	60/240

Folding saw



ITEM NO.	SIZE	BOX(CTN/PCS)
A0692-180	180mm	6/48

Hand saw



ITEM NO.	SIZE	BOX(CTN/PCS)
A0892-14	350mm/14"	12/48
A0892-16	400mm/16"	12/48
A0892-18	450mm/18"	12/48
A0892-20	500mm/20"	12/48

Grafting knife



Stainless steel heat treated for durability
Foldable blade for safe carriage

ITEM NO.	SIZE	BOX(CTN/PCS)
A0019		12/96

German type grafting knife

NEW!



ITEM NO.	SIZE	BOX(CTN/PCS)
A0019B-R	Right	12/96
A0019B-L	Left	12/96

Utility saw

SK5



ITEM NO.	SIZE	BOX(CTN/PCS)
A0992	350mm	6/24

Multi function saw



ITEM NO.	SIZE	BOX(CTN/PCS)
A0993	A0193	6/24

Axe



- Carbon steel heat treated.
- Steel pipe handle with rubber grip

ITEM NO.	SIZE	BOX(CTN/PCS)
A0799		6/24

Hose connector

1/2"

M0006



3/4"

M0007



Used for connection between hose and spraying equipment, suitable for 13mm (1/2inch) \19mm (3/4inch) hose

ITEM NO.	SIZE	BOX(CTN/PCS)
M0006	13mm (1/2")	120/720
M0007	19mm (3/4")	110/660

Luxury dual use tap adaptor



M0008

M0009

To be used in connection to screw faucet for mutual conversion between 1/2 inch and 3/4 inch (such as washing machine faucet).

To be used in connection to screw faucet, suitable for 13mm(1/2 inch) hose

ITEM NO.	SIZE	BOX(CTN/PCS)
M0008	13mm (1/2") -19mm(3/4")	120/720
M0009	13mm (1/2")	120/720

Universal Tap Connector

1/2"



Suitable for all 13mm(1/2 inch) water faucet with or without threads
Used to attach a 1/2"(standard type) garden hose to round or oval spout taps
The connector is sealed to the tap by tightening the stainless steel jubilee clip
Used in conjunction with hose connectors.

ITEM NO.	SIZE	BOX(CTN/PCS)
M0010	13mm (1/2")	120/720

Hose nozzle



- Brass nozzle for long-time performance.
- Impact plastic handle with steel lever.
- Quick plastic coupler included

ITEM NO.	BOX(CTN/PCS)
M0011 (A0705)	12/96

Hose nozzle



Quick hose connector for 1/2' & 3/4' hoses, to be clamped after connected

Male adaptor to be used with a quick-release hose connector

ITEM NO.	SIZE	BOX(CTN/PCS)
M0001	-	12/72

Gun nozzle with standard hose connector



- 1 Continuously adjustable water flow from hard jet to fine mist.
- 2 On/off trigger with lock.
- 3 Ergonomically shaped trigger for easy and convenient use.
- 4 Standard hose connector for connecting 13mm(1/2") hoses. Convenient leak-free connection of the spray gun to the hose. Also fits all other watering products.

13mm
1/2"

ITEM NO.	SIZE	BOX(CTN/PCS)
M0004-08	-	10/60

Portable hose reel set



- 1 Portable hose reel set, a household necessity, suitable for car and yacht washing, garden watering, floor and wall cleaning
- 2 Easy to assemble, no tools needed
- 3 Steel pipe frame epoxy coated to resist corrosion
- 4 Standard accessories: 4 pieces of coupler and hose connectors, 1 piece 7-pattern hose nozzle

ITEM NO.	SIZE	BOX(CTN/PCS)
M0012	-	1/3



BUDDY TOOLS

Hacksaw frame

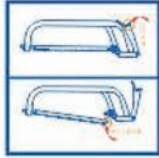

- All steel construction for heavy-duty work.
- Pull open handle to change used blades.
- Two saw blades included, one for steel, one for wood

ITEM NO.	SIZE	BOX(CTN/PCS)
BD-C0003	300mm/12'	6/24

Industrial grade grease gun



- Extra heavy-duty construction ideal for automobile, machines and equipments
- Working pressure:7000 psi.

ITEM NO.	SIZE	BOX(CTN/PCS)
BD-Y0020-400	400cc	-/12
BD-Y0020-600	600cc	-/12

Industrial grade grease gun



- Heavy-duty construction for professional operation and home use.
- Double air vent • Working pressure:6000 psi.

ITEM NO.	SIZE	BOX(CTN/PCS)
BD-Y0021	400cc	-/16

Industrial grade grease gun



- Heavy-duty construction for professional operation and D.I.Y.use.
- Both cartridge and bulk loading acceptable.
- Working pressure:6000 psi.

ITEM NO.	SIZE	BOX(CTN/PCS)
BD-Y0022	600cc	-/12

Industrial grade grease gun



- Heavy-duty construction for professional operation and D.I.Y.use.
- Both cartridge and bulk loading acceptable.
- Working pressure:6000 psi.

ITEM NO.	SIZE	BOX(CTN/PCS)
BD-Y0023	400cc	-/20

Industrial grade grease gun



- Heavy-duty construction for professional operation and D.I.Y.use.
- Both cartridge and bulk loading acceptable.
- Working pressure:6000 psi.

ITEM NO.	SIZE	BOX(CTN/PCS)
BD-Y0024	600cc	-/12

Industrial grade grease gun



- Light-weight and mini size make it an ideal tool for light-duty and outdoor operation
- Working pressure:3000 psi.

ITEM NO.	SIZE	BOX(CTN/PCS)
BD-Y0025	120cc	-/36

By-pass pruners

SK5



- Sk5 steel blade special treated for heavy-duty pruning work.
- Metal handle vinyle-dipped.
- Cutting capacity: fresh wood dia.20mm, dry wood dia.12mm

ITEM NO.	SIZE
BD-D0017	200mm/8"

By-pass pruners

SK5



- Sk5 steel blade special treated for heavy-duty pruning work.
- Metal handle with plastic grip.
- Cutting capacity: fresh wood dia.20mm, dry wood dia.12mm

ITEM NO.	SIZE
BD018	200mm/8"

By-pass pruners



- Sk5 steel blade special treated for heavy-duty pruning work.
- Aluminum handle vinyle-dipped with press-to-open lock.
- Cutting capacity: fresh wood dia.20mm, dry wood dia.12mm

ITEM NO.	SIZE
BD035	200mm/8"

臺灣
獨家代理
巴弟工具

Multi-function electrician's tool

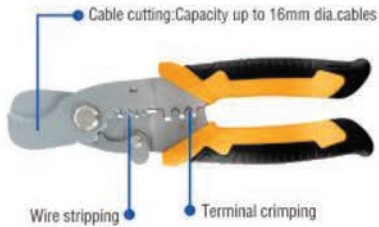

Cable cutting: Capacity up to 16mm dia.cables
 Made of high quality stainless steel, fully hardened with HRC 55
 Three functions combined,all up to professional standard

ITEM NO.	SIZE	BOX(CTN/PCS)
BA0143	175mm	12/72

Multi-function electrician's tool



Multi-cutter: for cutting wire,cable,wiring duct and metal sheet
 Made of high quality stainless steel, fully hardened with HRC 55
 Three functions combined,all up to professional standard

ITEM NO.	SIZE	BOX(CTN/PCS)
BA0144	200mm	12/72

Self-clamping wrench set



Auto-adjusting Claws
 10-19mm/13-24mm
 Suitable For Hex And Square Nuts
 Ratchet Function
 Single-hand Operation



ITEM NO.	SIZE	BOX(CTN/PCS)
BA0138	200mm/8"	6/36

Stainless steel scissors



Materials:stainless steel blades; zing alloy handle.
 Blade hardness:hrc: 54-56.
 Most suitable for the following applications



ITEM NO.	SIZE	BOX(CTN/PCS)
Bc0044		12/120

Black try square



ITEM NO.	SIZE	BOX(CTN/PCS)
Y2-043	400x600x2.0mm	-/36
Y2-044	200x300x2.0mm	-/100

臺灣巴弟工具
 獨家代理

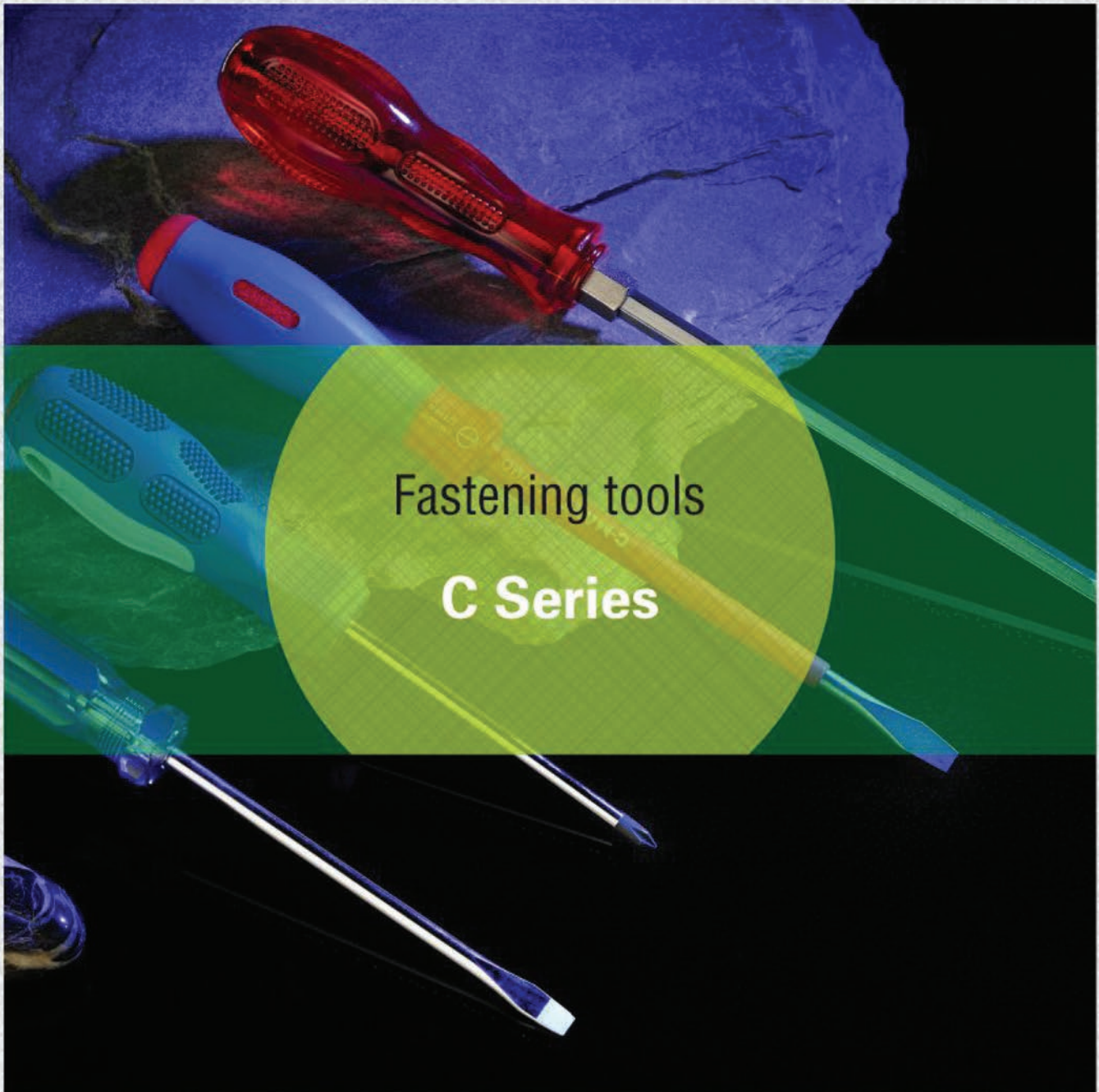

TAIWAN C-MART PRACTICAL TOOLS CO., LTD. / SHANGHAI C-MART TOOLS CO., LTD.

Caulking gun



• All metal construction

ITEM NO.	SIZE	BOX(CTN/PCS)
C0001-09	225mm/9"	8/32

Caulking gun



• All metal construction

ITEM NO.	SIZE	BOX(CTN/PCS)
C0002-09	225mm/9"	8/32

Caulking gun



• All metal construction

ITEM NO.	SIZE	BOX(CTN/PCS)
C0003-09	225mm/9"	8/32

Caulking gun



• All metal construction

ITEM NO.	SIZE	BOX(CTN/PCS)
C0004-09	225mm/9"	8/32

Heavy duty caulking gun



• All metal construction

ITEM NO.	SIZE	BOX(CTN/PCS)
C0005-09	225mm/9"	

Caulking gun - aluminum pipe



ITEM NO.	SIZE	BOX(CTN/PCS)
C0006-09	225mm/9"	6/24
C0006-15	375mm/15"	6/12

Rosin core solder



ITEM NO.	SIZE	BOX(CTN/PCS)
C0013-16	16g	-/-
C0013-250	200g	-/-
C0013-500	400g	10/40

Desoldering pump



ITEM NO.	SIZE	BOX(CTN/PCS)
C0014-08	200mm/8"	24/240

Soldering iron



ITEM NO.	SIZE	BOX(CTN/PCS)
C0016-30	30W	8/64
C0016-40	40W	8/64
C0016-60	60W	8/64
C0016-80	80W	8/64

Soldering iron



ITEM NO.	SIZE	BOX(CTN/PCS)
C0171-80	80W	8/48
C0171-100	100W	8/48
C0171-150	150W	8/48
C0171-200	200W	6/24
C0171-300	300W	6/24

Soldering iron



C0017A two-pin plug



C0017B three-pin plug

- Special treated tip, stainless steel pipe,
- Heat resistant plastic handle.
- A bonus stand included

ITEM NO.	SIZE	BOX(CTN/PCS)
C0017-30	30W	8/80
C0017-40	40W	8/80
C0017-60	60W	8/80
C0017-80	80W	8/80
C0017-100	100W	8/80

Soldering iron replacement parts



ITEM NO.	SIZE	BOX(CTN/PCS)
C0017A-30	30W	100/-
C0017A-40	40W	100/-
C0017A-60	60W	100/-
C0017A-80	80W	100/-
C0017A-100	100W	100/-
C0016A-30	30W	2/-
C0016A-40	40W	2/-
C0016A-60	60W	2/-
C0016A-80	80W	2/-

Soldering iron replacement parts



ITEM NO.	SIZE	BOX(CTN/PCS)
C0017B-30-Z	Z-Straight tips 30W	100/-
C0017B-40-Z	Z-Straight tips 40W	100/-
C0017B-60-Z	Z-Straight tips 60W	100/-
C0017B-80-Z	Z-Straight tips 80W	100/-
C0017B-100-Z	Z-Straight tips 100W	100/-
C0017B-30-W	W-Bent tips 30W	100/-
C0017B-40-W	W-Bent tips 40W	100/-
C0017B-60-W	W-Bent tips 60W	100/-
C0017B-80-W	W-Bent tips 80W	100/-
C0017B-100-W	W-Bent tips 100W	100/-

Heater core for hot air blower

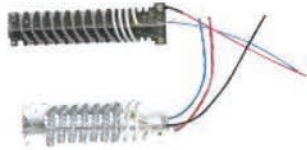

ITEM NO.	SIZE	BOX(CTN/PCS)
C0018A-1600	1600W	1/-
C0018A-2000	2000W	1/-
C0181A-1600	1600W	1/-
C0181A-1800	1800W	1/-

HOT AIR BLOWER



Circuit Board-12000 hours of warranty



Motor-300 hours of warranty

Heating core-1200 hours of warranty

- Hot air blower widely applied in various industries
- Powerful element provides sufficient heat for removal of paints and varnish, thawing of frozen pipes, heating shrink tubes and welding copper tube etc
- Variable temperature control allows selection of correct heat for a range of applications

ITEM NO.	RATED POWER	BOX(CTN/PCS)
C0018-1600	1600W	1/10
C0018-2000	2000W	1/10

Plastic welding torch



230V- 50Hz
50-300l/min
50-550°C

ITEM NO.	RATED POWER	BOX(CTN/PCS)
C0183-700	700W	1/20

Professional hot air blower



Voltage: 220V
Temperature: 50-400°C
Air volume: Low 190-210l/min
Function: hot / cool air

Power input: 1600W
Settings: 50-550°C
High: 310-350l/min
Adjustable temperature

ITEM NO.	RATED POWER	BOX(CTN/PCS)
C0181-1600	1600W	1/10
C0181-2000	2000W	1/10

Two-step hot air blower



Voltage: 220-240V
Temperature: 400/500°C
Air flow: 550/750L/min

Power input: 1800W
Switch control: 2 Stage[I / II]
Cable length: 2M

ITEM NO.	RATED POWER	BOX(CTN/PCS)
C0181-1800	1800W	1/10

Digital display hot air blower



2 SPEEDS controlled air volumes, allow you to match the air speed in your application.

The LCD digital readout display allows you to monitor the temperature via a digital display when precision control is needed.

The integration temperature control IC, accurate temperature control

ITEM NO.	RATED POWER	BOX(CTN/PCS)
C0018E-1600	1600W	1/10
C0018E-2000	2000W	1/10

Hot melt glue gun



- Professional quality, suitable for gluing plastic, metal, leather and wood. Keep in a dry place

ITEM NO.	RATED POWER	BOX(CTN/PCS)
C0019-60	60W	10/40
C0019-100	100W	10/40

Hot melt glue gun



Promotional item

ITEM NO.	RATED POWER	BOX(CTN/PCS)
C0191-60	60W	10/60

TOP QUALITY HOT AIR BLOWER



Variable temp & air flow

C0184E



2300W 50-650°C

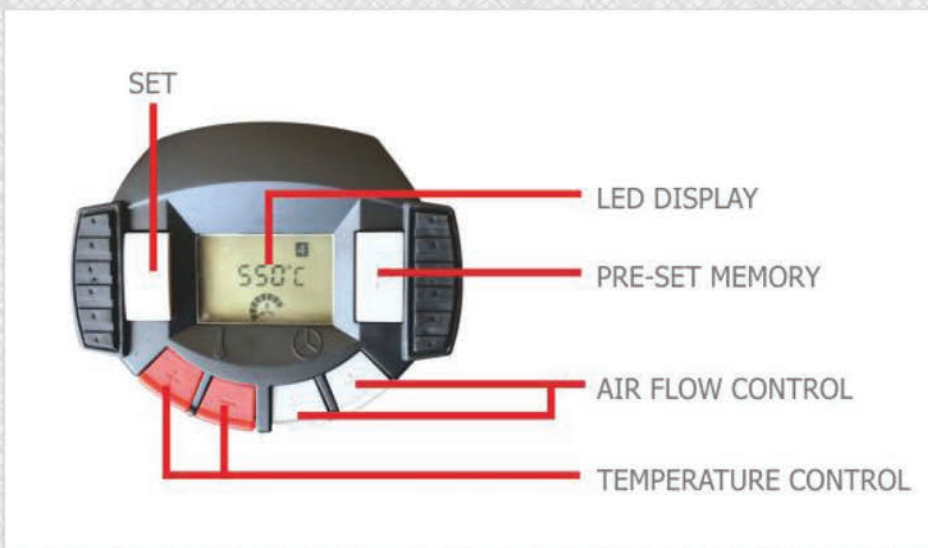

Smart control panel



Ceramic heater core for more concentrated heat and much longer stable working time than conventional mica heater element



Japan mabuchi motor ensures 550-700 hours of operational life span



Turbo fan instead of cooling fan is used for faster and more directional airflow

Aluminium alloy hand riveter



- Suitable for aluminum rivets and stainless steel rivets.
- Four interchangeable nosepieces for 2.4mm, 3.2mm, 4.0mm and 4.8mm rivets.

ITEM NO.	SIZE	BOX(CTN/PCS)
C0020-10	250mm/10"	6/36

Metal body hand riveter



- Suitable for aluminum rivets and stainless steel rivets.
- Four interchangeable nosepieces for 2.4mm, 3.2mm, 4.0mm and 4.8mm rivets.

ITEM NO.	SIZE	BOX(CTN/PCS)
C0021-10	250mm/10"	6/36

Heavy duty riveter

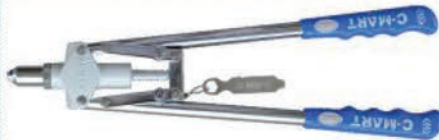

- Suitable for aluminum rivets and stainless steel rivets.
- Four interchangeable nosepieces for 2.4mm, 3.2mm, 4.0mm and 4.8mm rivets.

ITEM NO.	SIZE	BOX(CTN/PCS)
C0022-17	430mm/17"	1/12

Heavy duty riveter



PATENT DESIGN

Four sizes in one nosepiece

- Suitable for aluminum rivets and stainless steel rivets.
- Four interchangeable nosepieces for 2.4mm, 3.2mm, 4.0mm and 4.8mm rivets.

ITEM NO.	SIZE	BOX(CTN/PCS)
C0221	325mm/13"	1/18

Compact hand riveter

Industrial grade



- ※ Compact size for easy carrying
- ※ Effort-saving construction for easy operation
- ※ Ergo-shaped double colour handle
- ※ Suitable for aluminum rivets and stainless steel rivets



ITEM NO.	SIZE	BOX(CTN/PCS)
C0223	330mm	1/20

Hand riveter



- Suitable for aluminum rivets and stainless steel rivets.
- Four interchangeable nosepieces for 2.4mm, 3.2mm, 4.0mm and 4.8mm rivets.

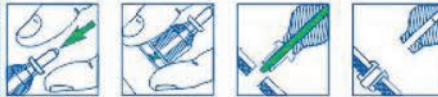

ITEM NO.	SIZE	BOX(CTN/PCS)
C0224	427mm	5/20

Hand riveter



C0225



C0226

- ※ GS/tuv Approved Product.
- ※ Suitable For Aluminum Rivets And Stainless Steel Rivets.
- ※ Four Interchangeable Nosepieces For 2.4mm, 3.2mm, 4.0mm And 4.8mm Rivets.

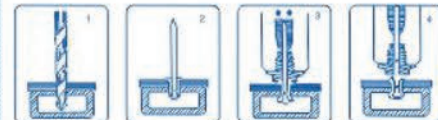

ITEM NO.	SIZE	BOX(CTN/PCS)
C0225	250mm	5/40
C0226	238mm	10/-

Professional nut riveter

10-PC SET



Mandrels and compatible nosepieces

Dismantling tool



ITEM NO.	SIZE	BOX(CTN/PCS)
C0222	M3 M4 M5 M6 M8 10 M12	1/6

Heavy duty 3 way staple gun



4-14mm
(5/32-9/16")



10-12mm
(3/8"-1/2")



10mm-14mm
(3/8"-9/16")

ITEM NO.	SIZE	BOX(CTN/PCS)
C0023	4-14mm	6/24

Uni-function staple gun



Narrow Crown Arrow 150 Rapid 140



- Adjustable driving force.
- All steel construction. Quick jam release.

ITEM NO.	SIZE	BOX(CTN/PCS)
C0024	4-8mm	10/40

Staples

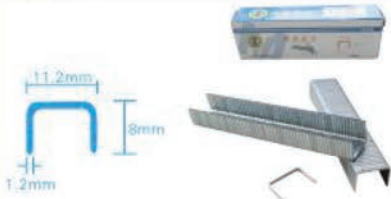

ITEM NO.	SIZE	BOX(CTN/PCS)
C0023A	11.2x8x1.2mm	1800/180000

Staples

For staple gun-C0024

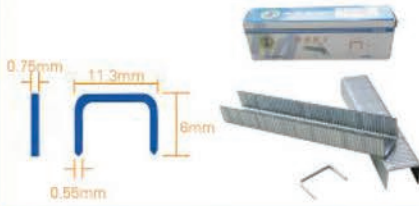

ITEM NO.	SIZE	BOX(CTN/PCS)
C0024B	11.3x6x0.55mm	1800/360000

Screwdrivers



ITEM NO.	SIZE	BOX(CTN/PCS)
C0030-3.275-A/B	3.2*75mm	12/240
C0030-3.2100-A/B	3.2*100mm	12/240
C0030-3.2150-A/B	3.2*150mm	12/240
C0030-3.2200-A/B	3.2*200mm	12/240
C0030-4.075-A/B	4.0*75mm	12/240
C0030-4.0100-A/B	4.0*100mm	12/240
C0030-4.0150-A/B	4.0*150mm	12/240
C0030-4.0200-A/B	4.0*200mm	12/240
C0030-5.075-A/B	5.0*75mm	12/240
C0030-5.0100-A/B	5.0*100mm	12/240
C0030-5.0125-A/B	5.0*125mm	12/240
C0030-5.0150-A/B	5.0*150mm	12/240
C0030-5.0200-A/B	5.0*200mm	12/240
C0030-6.075-A/B	6.0*75mm	12/144
C0030-6.0100-A/B	6.0*100mm	12/144
C0030-6.0125-A/B	6.0*125mm	12/144
C0030-6.0150-A/B	6.0*150mm	12/144
C0030-6.0200-A/B	6.0*200mm	12/144

Screwdrivers, Cr.Mo steel



ITEM NO.	SIZE	BOX(CTN/PCS)
C0031-6.0100-A/B	6.0*100mm	12/144
C0031-6.0125-A/B	6.0*125mm	12/144
C0031-6.0150-A/B	6.0*150mm	12/144
C0031-6.0200-A/B	6.0*200mm	12/144
C0031-6.0250-A/B	6.0*250mm	12/144

Screwdrivers



編號	規格	盒箱(支)
C0032-3.250-A/B	3.2*50mm	12/480
C0032-3.275-A/B	3.2*75mm	12/480
C0032-3.2100-A/B	3.2*100mm	12/480
C0032-3.2150-A/B	3.2*150mm	12/480
C0032-3.2200-A/B	3.2*200mm	12/480
C0032-5.075-A/B	5.0*75mm	12/240
C0032-5.0100-A/B	5.0*100mm	12/240
C0032-5.0125-A/B	5.0*125mm	12/240
C0032-5.0150-A/B	5.0*150mm	12/240
C0032-5.0200-A/B	5.0*200mm	12/192
C0032-5.0250-A/B	5.0*250mm	12/144
C0032-5.0300-A/B	5.0*300mm	12/144
C0032-6.040-A/B	6.0*40mm	12/240
C0032-6.075-A/B	6.0*75mm	12/240
C0032-6.0100-A/B	6.0*100mm	12/240
C0032-6.0125-A/B	6.0*125mm	12/240
C0032-6.0150-A/B	6.0*150mm	12/240
C0032-6.0200-A/B	6.0*200mm	12/192
C0032-6.0250-A/B	6.0*250mm	12/144
C0032-6.0300-A/B	6.0*300mm	12/144
C0032-8.0150-A/B	8.0*150mm	12/120
C0032-8.0200-A/B	8.0*200mm	12/120

Impact screwdrivers



ITEM NO.	SIZE	BOX(CTN/PCS)
C0033-6.0100-A	Ph2 6.0*100mm	12/120
C0033-6.0150-A	Ph2 6.0*150mm	12/120
C0033-8.0150-A	Ph3 8.0*150mm	12/72
C0033-8.0200-A	Ph3 8.0*200mm	12/72
C0033-8.0250-A	Ph3 8.0*250mm	12/72
C0033-8.0300-A	Ph3 8.0*300mm	12/72
C0033-6.0100-B	6.0*100mm	12/120
C0033-6.0150-B	6.0*150mm	12/120
C0033-8.0150-B	8.0*150mm	12/72
C0033-8.0200-B	8.0*200mm	12/72
C0033-8.0250-B	8.0*250mm	12/72
C0033-8.0300-B	8.0*300mm	12/72

Screwdriver-torx head



ITEM NO.	SIZE	BOX(CTN/PCS)
C0341-T08	T8	12/96
C0341-T09	T9	12/96
C0341-T10	T10	12/96
C0341-T15	T15	12/96
C0341-T20	T20	12/96
C0341-T25	T25	12/96
C0341-T27	T27	12/96
C0341-T30	T30	12/96
C0341-T40	T40	12/96

Screwdrivers



編號	規格	盒箱(支)
C0034-3.075-A/B	3.0*75mm	12/120
C0034-3.0100-A/B	3.0*100mm	12/120
C0034-3.0125-A/B	3.0*125mm	12/120
C0034-3.0150-A/B	3.0*150mm	12/120
C0034-3.0200-A/B	3.0*200mm	12/120
C0034-5.075-A/B	5.0*75mm	12/120
C0034-5.0100-A/B	5.0*100mm	12/120
C0034-5.0125-A/B	5.0*125mm	12/120
C0034-5.0150-A/B	5.0*150mm	12/120
C0034-5.0200-A/B	5.0*200mm	12/120
C0034-5.0250-A/B	5.0*250mm	12/120
C0034-5.0300-A/B	5.0*300mm	12/120
C0034-6.040-A/B	6.0*40mm	12/120
C0034-6.075-A/B	6.0*75mm	12/120
C0034-6.0100-A/B	6.0*100mm	12/120
C0034-6.0125-A/B	6.0*125mm	12/120
C0034-6.0150-A/B	6.0*150mm	12/120
C0034-6.0200-A/B	6.0*200mm	12/120
C0034-6.0250-A/B	6.0*250mm	12/120
C0034-6.0300-A/B	6.0*300mm	12/120
C0034-8.0150-A/B	8.0*150mm	12/120
C0034-8.0200-A/B	8.0*200mm	12/120
C0034-8.0250-A/B	8.0*250mm	12/120
C0034-8.0300-A/B	8.0*300mm	12/120

Insulation screwdrivers



ITEM NO.	SIZE	BOX(CTN/PCS)
C0035-PH075-A	PH0*75mm	12/96
C0035-PH1100-A	PH1*100mm	12/96
C0035-PH2100-A	PH2*100mm	12/96
C0035-3.0100-B	3.0*100mm	12/96
C0035-5.0125-B	5.0*125mm	12/96
C0035-6.5150-B	6.5*150mm	12/96

Precision screwdrivers



ITEM NO.	SIZE	BOX(CTN/PCS)
C0038-1.2	1.2mm	36/720
C0038-1.4	1.4mm	36/720
C0038-1.8	1.8mm	36/720
C0038-2.0	2.0mm	36/720
C0038-2.4	2.4mm	36/720
C0038-3.0	3.0mm	36/720

Two way screwdrivers-slotted & philips



• Chrome vanadium steel, magnetized tip

ITEM NO.	SIZE	BOX(CTN/PCS)
C0041-6.340	6.3*40mm/1.5"	12/120
C0041-6.3100	6.3*100mm/4"	12/120
C0041-6.3125	6.3*125mm/5"	12/120
C0041-6.3150	6.3*150mm/6"	12/120
C0041-6.3200	6.3*200mm/8"	

6 in 1 screwdriver set

CR-V

※ SLOTTED:



※ PHILLIPS:



※ NUT DRIVER:



Including:
2pcs bits

6.3x65mm (+)PH1x(-)3/16

8x75mm (+)PH2x(-)1/4

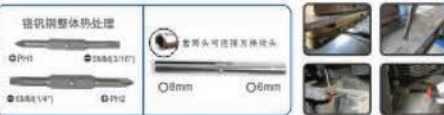

ITEM NO.	SIZE	BOX(CTN/PCS)
C0039	6 in 1	

6-pc screwdriver set



- Screwdriver bits made of carbon steel heat treated.
- Chrome plated handle with swivel cap.
- For electronics, watches and hobby

ITEM NO.	SIZE	BOX(CTN/PCS)
C0025	#1, #0, 1.4mm, 2.0mm 2.4mm, 3.0mm	12/108

16-pc precision screwdriver & set



14PC BITS:

⊕ PH000, PH00, PH0, PH1

⊕ T5, T6, T7, T8, T9

⊖ 1.5 2.0 2.5 3.0 4.0mm

1PC BIT DRIVER

1PC EXTENSION BAR

ITEM NO.	SIZE	BOX(CTN/SET)
C0027	16-pc set	6/24

Smart phone repair tool kit



- ⊕ PH00
- ⊕ T4
- ⊕ T8
- ⊕ 0.8mm
- ⊕ T6
- ⊖ 1.2mm
- ⊕ PH000
- ⊕ T5
- ⊕ T10
- ⊕ 2.0mm
- ⊕ T7
- ⊕ 2.0mm

ITEM NO.	SIZE	BOX(CTN/SET)
C0028	17-PC SET	

8-pc impact screwdriver set



36mm length S2 driver bits

⊕ PH1 PH2

75mm length S2 driver bits

⊕ PH 2

MPACT SCREWDRIVER

ITEM NO.	SIZE	BOX(CTN/SET)
C0029	8-pc set	1/20

6-pc screwdriver set

- ⊖ 3.5 x 75mm
- 4 x 100mm
- 6 x 150mm

- ⊕ 3.5 x 60mm Ph0
- 5 x 100mm Ph1
- 6 x 125mm Ph2

鍍鉻鋼,附磁頭



- Chrome vanadium steel, magnetized tip

ITEM NO.	SIZE	BOX(CTN/SET)
C0036	6-PC SET	6/48

7-pc insulation screwdriver set



- ⊖ 3.0 x 100mm
- 6.5 x 150mm
- 5.0 x 125mm

- ⊕ Ph0 3.0 x 75mm
- Ph1 5.0 x 100mm
- Ph2 6.5 x 100mm

- Chrome vanadium steel, magnetized tip

ITEM NO.	SIZE	BOX(CTN/SET)
C0351	7-pc set	1/24

8-pc screwdriver set



- ⊖ Ph2x38mm Ph1x75mm
- Ph2x100mm Ph2x150mm
- ⊕ 6x38mm 5x75mm 6x100mm 6x150mm

ITEM NO.	SIZE	BOX(CTN/SET)
C0361	8-pc set	1/11

8-pc screwdriver set



- ⊕ T8x75mm T10x100mm T15x100mm
- T20x100mm T25x100mm T27x115mm
- T30x125mm T40x150mm

ITEM NO.	SIZE	BOX(CTN/SET)
C0362	8-pc set	1/11

7pc precision screwdriver set



- ⊕ 0.8mm
- ⊕ PH000
- ⊖ 1.2mm
- ⊖ T5 T6



Bits made of chrome vanadium steel
Aluminum handle for better performance.
Ideal tool for maintenance of smart phones,
i-pad, cameras, watches and glasses
One magnetizer/demagnetizer included

Bits made of chrome vanadium steel

ITEM NO.	SIZE	BOX(CTN/SET)
C0050	7-pc set	12/48

31pc precision ratchet screwdriver set



ITEM NO.	SIZE	BOX(CTN/SET)
C0051	31-PC SET	6/24

C0042

HEAVY-DUTY ELECTRIC SCREWDRIVER

High efficiency taiwan servo motor
Stepless speed regulating start switch
Replaceable carbon brush greatly prolongs its durability
Stepless torque adjustment

Input voltage: AC 200-240V
Torque range: 5-60kgf.cm
No load speed: 900rpm \pm 10%
Repeat torque accuracy: \pm 0.5%

Applicable screws: 2 - 8mm
Noise degree: 65dB(A)
Weight: 0.6kg



BUY ONE .PLUS ONE



C0431 SEMI-AUTO ELECTRIC SCREWDRIVERS

ITEM#	INPUT VOLTAGE (AC/DC-V)	OUTPUT TORQUE (kgf.cm)	NO LOAD SPEED (rpm)	BITS APPLICABLE (mm)
C0431-04	DC-36V	2-15	1300	\varnothing 4
C0431-05	DC-36V	2-25	1400	\varnothing 5
C0431-06	DC-36V	3-35	1100	\varnothing 6
C0431-1/4	DC-36V	3-35	1100	\varnothing SS1/4

C0043 | C0044 | C0045 SEMI-AUTO | FULL-AUTO | AC-DIRECT PLUG-IN

ELECTRIC SCREWDRIVER COMPONENT DIAGRAM

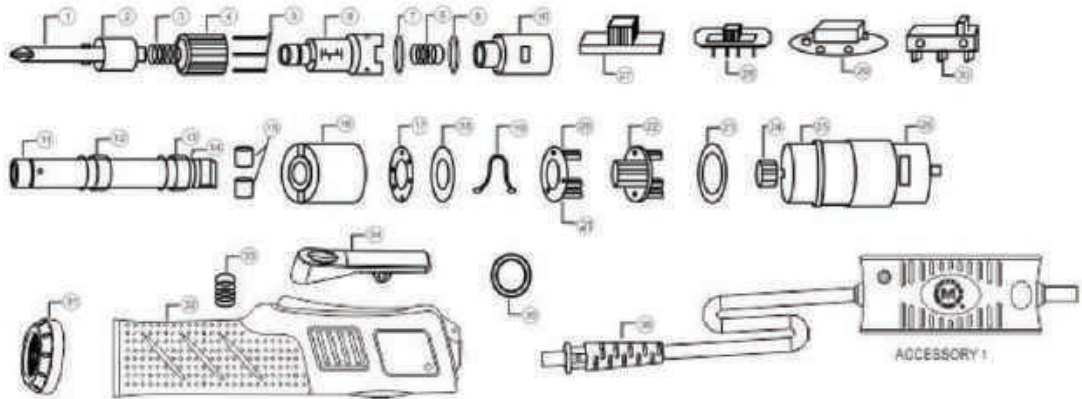

NO.	NAME	QUANTITY	NO.	NAME	QUANTITY	NO.	NAME	QUANTITY	NO.	NAME	QUANTITY	NO.	NAME	QUANTITY
1	Bit	1	9	Washer	1	17	Flat bearings	1	25	Connector bar	1	33	Press button spring	1
2	Lock sleeve	1	10	Cabriet	1	18	Bearing pedestal	1	26	Motor	1	34	Press button	1
3	Lock sleeve spring	1	11	Main axle	1	19	Circle	1	27	Reversible switch cap	1	35	Hanging ring	1
4	Torque adjustment knob	1	12	Front bearing	1	20	Planet carrier	1	28	Reversible switch	1	36	Cable only	1
5	Position pins	3	13	Rear bearing	1	21	Planet gear	6	29	Circuit board	1			
6	Torque block	1	14	Cuship	1	22	Planet carrier	1	30	Start switch	1			
7	Washer	1	15	Rolling bearings	2	23	Washer	1	31	Handle cap	1			
8	Torque spring	1	16	Inner gear sleeve	1	24	Motor gear	1	32	Double-color handle	1			

PATENTED Industrial grade ELECTRIC SCREWDRIVERS



- ※ Taiwan motor
- ※ Silver alloy switch for durability
- ※ High speed, high torque
- ※ Cold-pressed axis for steady and straight operation
- ※ Ergonomic dual-colour non-slip handle



Item# C0043 SEMI-AUTO ELECTRIC SCREWDRIVER
 Item# C0044 FULL-AUTO ELECTRIC SCREWDRIVER
 Item# C0045 AC-DIRECT PLUG-IN ELECTRIC SCREWDRIVER

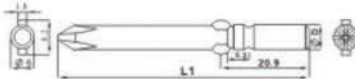

ITEM#	INPUT VOLTAGE (AC/DC-V)	OUTPUT TORQUE (kgf.cm)	NO LOAD SPEED (rpm)	BITS APPLICABLE (mm)	QTY.
C0043-04	DC-36V	2~15	1300	Φ4	20PCS
C0043-05	DC-36V	2~25	1400	Φ5	20PCS
C0043-06	DC-36V	3~35	1100	Φ6	20PCS
C0043-1/4	DC-36V	3~35	1100	Φ S51/4	20PCS
C0044-04	DC-36V	2~15	1300	Φ4	20PCS
C0044-05	DC-36V	2~25	1400	Φ5	20PCS
C0044-06	DC-36V	3~35	1100	Φ6	20PCS
C0044-1/4	DC-36V	3~35	1100	Φ S51/4	20PCS
C0045-05	AC-200~240V	2~20	1000	Φ5	20PCS
C0045-06	AC-200~240V	3~28	900	Φ6	20PCS
C0045-1/4	AC-200~240V	3~28	900	Φ S51/4	20PCS
C0043-04D	DC-36V	2~15	1300	Φ4	20PCS
C0043-05D	DC-36V	2~25	1400	Φ5	20PCS
C0043-06D	DC-36V	3~35	1100	Φ6	20PCS
C0043-1/4D	DC-36V	3~35	1100	Φ S51/4	20PCS
C0044-04D	DC-36V	2~15	1300	Φ4	20PCS
C0044-05D	DC-36V	2~25	1400	Φ5	20PCS
C0044-06D	DC-36V	3~35	1100	Φ6	20PCS
C0044-1/4D	DC-36V	3~35	1100	Φ S51/4	20PCS



Electric screwdriver 700A



ITEM NO.	SIZE	BOX(CTN/PCS)
C0048-05	Φ5	
C0048-06	Φ6	
C0048-1/4	Φ S1/4	

Variable frequency power controller



- Inverter dc design saves electricity and environment friendly
- Super strong start and high anti-stall torque
- Automatic constant current control allows screwdriver to perform smoothly and prolongs its working life
- High power, long life, new style

ITEM NO.	SIZE	BOX(CTN/PCS)
C0046-80	80W	-/20
C0046-160	160W	1/50

Soldering station



Input voltage: 110/220VAC Elective 50/60Hz
 Output voltage: 24V Power: 60W
 Max.instant power ≤ 60W Temperature range: 200-480 °C
 Bits earth resistance: <2 Ω Bits drain voltage: <2mV

ITEM NO.	SIZE	BOX(CTN/PCS)
C0936	60W	

INDUSTRIAL LEVEL ELECTRIC SCREWDRIVER

- ※ Ergonomic handle bar, heat resistant, shock-proof and comfortable to hold
- ※ Super stable torque control even at the minimum torque position of 0.5 kgf.cm with accuracy up to $\pm 5\%$
- ※ Our compact high quality power controller with stepless speed control allows the machine to run for a long time with no worry of over heat and without much noise
- ※ Speed ranges from 500 rpm/min. to 1400 rpm/min.
- ※ High-tech precision DC motor from Taiwan ensures steady and efficient operation
- ※ Best used on toy, home appliance, furniture and other product assembly lines



ITEM#	INPUT VOLTAGE (AC/DC-V)	OUTPUT TORQUE (kgf.cm)	NO LOAD SPEED (rpm)	BITS APPLICABLE (mm)
C0049-04	DC-36V	2~15	900-1400	Φ 4
C0049-05	DC-36V	2~25	1000-1500	Φ 5
C0049-06	DC-36V	5~35	700-1200	Φ 6
C0049-1/4	DC-36V	5~35	700-1200	Φ SS1/4

Cordless screwdriver



Input voltage	12V
Rated power	30W/h
Weight	200g
Battery life	500/times
Battery capacity	2000mAh
Specs.	36x39x80(h)

ITEM NO.	SIZE	BOX(CTN/PCS)
W0032	1/4"	

Cordless screwdriver-mini type



The smallest screwdriver in the world with torque adjustment function
 Torque range: 0.01N.m~0.3N.m
 Charging mode: wireless and plug in selectable
 Easy to carry and store
 Unique clutch release mechanism to protect screws from damage

Torque adjustment	stepless
Torque	0.01~0.1(0.1~1)
No load speed	250
Battery capacity	350mAh
Weight	60
Specs.	130x8

ITEM NO.	SIZE	BOX(CTN/PCS)
W0047	1/2"	



Cutting tools
A Series

TAIWAN C-MART PRACTICAL TOOLS CO., LTD. / SHANGHAI C-MART TOOLS CO., LTD.

Utility cutter



All new abs handle, metal shaft

ITEM NO.	SIZE	BOX(CTN/PCS)
A0001	100*18*0.5mm	12/96

Utility cutter



All new abs handle, metal shaft

ITEM NO.	SIZE	BOX(CTN/PCS)
A0002	100*18*0.5mm	12/96

Utility cutter set



All new abs handle, metal shaft,
with a 10-pc tube of cutter blades free

ITEM NO.	SIZE	BOX(CTN/PCS)
A0002+10	100*18*0.5mm	12/96

Plastic cutter



• Abs case, stainless steel shaft with 3 pcs
of extra blades stored inside handle

ITEM NO.	SIZE	BOX(CTN/PCS)
A0003		10/120

Plastic cutter blade



ITEM NO.	SIZE	BOX(CTN/PCS)
A0003B		5/60/3600

Utility cutter



All new abs handle, metal shaft

ITEM NO.	SIZE	BOX(CTN/PCS)
A0004	100*18*0.5mm	12/96

Utility cutter set



All new abs handle, metal shaft,
with a 10-pc tube of cutter blades free

ITEM NO.	SIZE	BOX(CTN/PCS)
A0004+10	100*18*0.5mm	12/96

Heavy duty utility knife



All new abs handle, metal shaft

ITEM NO.	SIZE	BOX(CTN/PCS)
A0007	127*25*0.7mm	12/72

Utility knife--zinc alloy



• Zinc alloy construction, extra blades installed inside case

ITEM NO.	SIZE	BOX(CTN/PCS)
A0012	60*19*0.6mm	12/96

Utility knife--zinc alloy



• Zinc alloy handle and super high carbon steel blades.
• Hardness of blades: HRC 61-62°

ITEM NO.	SIZE	BOX(CTN/PCS)
A0015	100*18*0.5mm	12/96

Utility cutter set



- 1-A0004 CUTTER
- 1-A0008 CUTTER
- 10-A0041B BLADES
- 10-A0042 BLADES.

ITEM NO.	SIZE	BOX(CTN/PCS)
A0408+20	100*18*0.5mm 80*9*0.4mm	12/120

Auto-loading utility knife 18mm WIDE BLADE

**5 BLADES
SELF LOADING**



- 5 blades stored inside
- Automatic blade loading mechanism
- Positive blade locking at any position

ITEM NO.	SIZE	BOX(CTN/PCS)
A0005	100*18*0.5mm	12/96

Utility knife



- ABS case and super high carbon steel blades.
- Hardness of blades: hrc55-58.

ITEM NO.	SIZE	BOX(CTN/PCS)
A0009	100*18*0.5mm	12/96

Light duty utility cutter



• Abs case, stainless steel shaft

ITEM NO.	SIZE	BOX(CTN/PCS)
A0008	80*9*0.4mm	20/400

Light duty utility cutter



• Stainless steel case

ITEM NO.	SIZE	BOX(CTN/PCS)
A0010	80*9*0.4mm	16/160

Cutter blade

SK5



BLADE SIZE: 100*18*0.5mm

- Sk5 super high carbon steel, Double ground cutting edge
- 7 or 14 snap off segments available

ITEM NO.	SIZE	BOX(CTN/PCS)
A0041-07	7 segments	200/2400
A0041-14	14 segments	200/2400

Cutter blade

SK7



BLADE SIZE: 100*18*0.5mm

- Sk7 super high carbon steel,
- Double ground cutting edge
- 7 or 14 snap off segments available

ITEM NO.	SIZE	BOX(CTN/PCS)
A0041B-07	7 segments	200/2400
A0041B-14	14 segments	200/2400

Cutter blade



BLADE SIZE: 100*18*0.5mm

- Double ground cutting edge
- 7 or 14 snap off segments available

ITEM NO.	SIZE	BOX(CTN/PCS)
A0041C-07	7 segments	200/2400
A0041C-14	14 segments	200/2400

Cutter blade



- Double ground cutting edge
- 7 or 14 snap off segments available

ITEM NO.	SIZE	BOX(CTN/PCS)
A0042	80*9*0.4mm	200/4000

Cutter blade



- Sk5 super high carbon steel,
- Double ground cutting edge

ITEM NO.	SIZE	BOX(CTN/PCS)
A0043	127*25*0.7mm	200/1000

Cutter blade



- Sk5 super high carbon steel,
- Double ground cutting edge

ITEM NO.	SIZE	BOX(CTN/PCS)
A0044	60*19*0.6mm	200/2400
A0441	60*19*0.6mm	200/2400

14-pc precision carving knife set

SK5



- 12pc Sk5 medium and heavy duty blades
- 1pc rubber coated blades holder with 1pc Sk5 #11 blades
- 1pc deluxe grip blade handle, with 1pc Sk5 blades

ITEM NO.	SIZE	BOX(CTN/PCS)
A0301-14	-	-/-

Electrician's knife



- Imported stainless steel
- Imported hard black wood
- Stainless steel, heat-treated, hardwood handle, foldable
- Blade hardness: 50-52°

ITEM NO.	SIZE	BOX(CTN/PCS)
A0048	Straight blade	12/96
A0049	Curved blade	12/96

Bolt clippers



Hardness of material to be cut does not exceed hrc30°



- Drop forged from cr.mo. Steel

ITEM NO.	SIZE	BOX(CTN/PCS)
A0074-12	300mm/12"	1/20
A0074-14	350mm/14"	1/10
A0074-18	450mm/18"	1/10
A0074-24	600mm/24"	1/8
A0074-30	750mm/30"	1/5
A0074-36	900mm/36"	1/4
A0074-42	1050mm/42"	1/2
A0074-48	1200mm/48"	1/2

Bolt clippers



- Drop forged from cr.mo. Steel

ITEM NO.	SIZE	BOX(CTN/PCS)
A0074B-18	450mm/18"	-/40
A0074B-24	600mm/24"	-/16
A0074B-30	750mm/30"	-/16
A0074B-36	900mm/36"	-/9
A0074B-42	1050mm/42"	-/9
A0074B-48	1200mm/48"	-

Mini bolt clippers



A0072-08



A0073-08

- Drop forged from chrome vanadium steel
- Cutting capacity: soft wires 3.5mm
- hard wires 2mm

ITEM NO.	SIZE	BOX(CTN/PCS)
A0072-08	200mm/8"	12/48
A0073-08	200mm/8"	12/48

Bolt clippers



Hardness of material to be cut does not exceed hrc30°

- Drop forged from high carbon steel

ITEM NO.	SIZE	BOX(CTN/PCS)
A0741-12	300mm/12"	1/30
A0741-14	350mm/14"	1/30
A0741-18	450mm/18"	1/20
A0741-24	600mm/24"	1/10
A0741-30	750mm/30"	1/5
A0741-36	900mm/36"	1/5
A0741-42	1050mm/42"	1/3

Wire rope cutter



Hardness of material to be cut does not exceed hrc30°

- Drop forged from cr.mo. Steel

ITEM NO.	SIZE	CUTTING CAPACITY	BOX(CTN/PCS)
A0076-08	200mm/8"	16mm	12/48
A0076-24	600mm/24"	12mm	1/6
A0076-36	900mm/36"	14mm	1/4

Ratchet cable cutters



A0075-180



A0075-240



A0075-400



ITEM NO.	SIZE	CUTTING CAPACITY	BOX(CTN/PCS)
A0075-180	180mm ²	180mm	1/20
A0075-240	240mm ²	260mm	1/20
A0075-400	400mm ²	300mm	1/10

Cable cutter

CR-V



• Drop forged from chrome vanadium steel

ITEM NO.	SIZE	CUTTING CAPACITY	BOX(CTN/PCS)
A0077-06	150mm/6"	10mm ²	12/96
A0077-08	200mm/8"	20mm ²	6/48
A0077-10	250mm/10"	38mm ²	6/48

Cable cutter



CR-V

• Drop forged from chrome vanadium steel

ITEM NO.	SIZE	CUTTING CAPACITY	BOX(CTN/PCS)
A0177-10	250mm/10"	60mm ²	6/48

Cable cutter(steel pipe)



STEEL PIPE HANDLE

A0078-24-S



ALUMINUM HANDLE

A0078-24-A

• Drop forged from chrome vanadium steel

ITEM NO.	SIZE	CUTTING CAPACITY	BOX(CTN/PCS)
A0078-24-A	600mm/24"	250mm ²	1/10
A0078-24-S	600mm/24"	250mm ²	1/6
A0078-36	900mm/36"	325mm ²	1/4

Steel tape cutter



• Blades made of drop forged chrome vanadium steel

ITEM NO.	SIZE	BOX(CTN/PCS)
A0071-18	450mm/18"	1/10

High carbon steel wood chisel



ITEM NO.	SIZE	BOX(CTN/PCS)
A0188-3/8	3/8" [10.0mm]	12/72
A0188-1/2	1/2" [12.5mm]	12/72
A0188-5/8	5/8" [15.6mm]	12/72
A0188-3/4	3/4" [19.0mm]	12/72
A0188-1	1" [25.0mm]	12/72
A0188-1-1/4	1-1/4 [31.0mm]	12/72
A0188-1-1/2	1-1/2 [37.5mm]	12/72

Cold chisel

CR-V



ITEM NO.	SIZE	BOX(CTN/PCS)
A0288-150	150mm	6/96
A0288-200	200mm	6/60
A0288-250	250mm	6/48

Hacksaw frame



Heavy duty

• All metal construction for heavy duty performance

ITEM NO.	SIZE	BOX(CTN/PCS)
A0089	300mm/12"	6/24

Hacksaw frame



Improved model

• Aluminum handle & steel pipe chrome plated

ITEM NO.	SIZE	BOX(CTN/PCS)
A0189	300mm/12"	12/36

Hacksaw frame



ITEM NO.	SIZE	BOX(CTN/PCS)
A0389	150mm/6"	12/120

Hacksaw frame



• Double colour aluminum handle.
• One bi-metal saw blade provided

ITEM NO.	SIZE	BOX(CTN/PCS)
A0289	300mm/12"	6/24

Hacksaw frame

SK4



Hard & flexible

ITEM NO.	SIZE	BOX(CTN/PCS)
A0090-18	18T 300mm/12"	100/1000
A0090-24	24T 300mm/12"	100/1000
A0090-32	32T 300mm/12"	100/1000

Bi-metal hacksaw blade



Flexible

ITEM NO.	SIZE	BOX(CTN/PCS)
A0901-18	300mm/12" 18T	100/1000
A0901-24	300mm/12" 24T	100/1000
A0901-32	300mm/12" 32T	100/1000

Tinman's snips, british type



ITEM NO.	SIZE	BOX(CTN/PCS)
A0095-08	200mm/8"	6/72
A0095-10	250mm/10"	6/48
A0095-12	300mm/12"	6/24
A0095-14	350mm/14"	6/24

Tinman's snips, American type



ITEM NO.	SIZE	BOX(CTN/PCS)
A0951-08	200mm/8"	8/32
A0951-10	250mm/10"	8/32
A0951-12	300mm/12"	8/32

Tinman's snips, japan type

A0952B-08
Stainless



A0952-08
SK5



Metal handle with plastic grip for comfort.
Capacity: mild steel 0.9mm, stainless steel 0.6mm in dia. and metal stud and metal runner.



Steel plate



Waved steel plate



Stainless steel plate



Metal stud & runner

ITEM NO.	SIZE	BOX(CTN/PCS)
A0952-08	200mm/8"	8/64
A0952B-08	200mm/8"	6/48

Tailoring scissors-industrial grade



• High carbon steel drop forged and chrome plated

ITEM NO.	SIZE	BOX(CTN/PCS)
A0020-10	250mm/10"	6/48
A0020-11	275mm/11"	6/48
A0020-12	300mm/12"	6/48

Aviation snips

CR-MO



• Chrome molybdenum steel drop forged.
• Ergo-shaped soft handle.

ITEM NO.	SIZE	BOX(CTN/PCS)
A0096-L		6/54
A0096-R		6/54
A0096-S		6/54

Hollow punch

CR-V



• Chrome vanadium steel heat treated

ITEM NO.	SIZE	BOX(CTN/PCS)
A0107-03	3*8*100mm	18/144
A0107-04	4*9*100mm	18/144
A0107-05	5*10*110mm	18/144
A0107-06	6*11*110mm	18/144
A0107-08	8*13*110mm	18/144
A0107-10	10*15*120mm	18/144
A0107-12	12*17*120mm	18/144

6-pc punch set

CR-V

3pc pin punch:
3*10*150-
5*10*150-
8*12*150mm
3pc taper punch:
3*10*150-
5*10*150-
8*12*150mm



• Chrome vanadium steel heat treated

ITEM NO.	SIZE	BOX(CTN/SET)
A0117	6-pc set	1/20

6-pc punch & chisel set

CR-V

2pc cold chisel:
15*12*150
11*10*130mm
1pc pin punch:
5*12*150mm
1pc center punch:
3*10*120mm
1pc taper punch:
3*10*120mm
1pc cape chisel:
4*10*130mm



• Chrome vanadium steel heat treated

ITEM NO.	SIZE	BOX(CTN/SET)
A0127	6-pc set	1/20

Hollow punch

CR-V



• Chrome vanadium steel heat treated

ITEM NO.	SIZE	BOX(CTN/PCS)
A0108-03	3*10*150mm	10/200
A0108-04	4*10*150mm	10/200
A0108-05	5*10*150mm	10/200

20pc metric tap and die set

- Manufactured from Alloy steel
- 9 PC Dies:
3x0.5 4x0.7 5x0.8
6x1.0 7x1.0 8x1.25
10x1.5 12x1.75 1/8-27
- 9 Pc Taps: Sizes as dies
- 1 Pc Tap wrench
- 1 Pc Die handle 1"OD



ITEM NO.	SIZE	BOX(CTN/SET)
A1011	20-pc set	1/16

40pc tap and die set-metric and unc

- Manufactured from alloy steel
- Iron case packed

- 17 PC Dies:
M3x0.5 M4x0.7 M5x0.8
M6x1.0 M7x1.0 M8x1.25
M10x1.5 M12x1.75
1/8NPT27 4NC40 6NC32
8NC32 1/4NC20
5/16NC18 3/8NC16
7/16NC14 1/2NC13
- 17 Pc Taps: Sizes as dies
- 1 Pc Tap wrench
- 1 Pc Die handle 1"OD
- 1 PcT type tap wrench 1/4" capacity
- 1 Pc Screwpitch gauge
- 1 Pc Screwdriver



ITEM NO.	SIZE	BOX(CTN/SET)
A1012	40-pc set	1/12

5pc spiral fluted screw extractor set

- No.1 1/8"-1/4"
- No.2 1/4"-5/16"
- No.3 5/16"-7/16"
- No.4 7/16"-9/16"
- No.5 9/16"-3/4"



ITEM NO.	SIZE	BOX(CTN/SET)
A0101	5-pc set	12/96



Glass cutter



NEW!



Screw open end cover



Put into handle kerosene or other suitable lubricants and screw tight cover

- ※ Tungsten carbide cutter wheel for sharpness and durability
- ※ Handle made of impact plastic with metal lid

ITEM NO.	SIZE	BOX(CTN/PCS)
A0115	Plastic handle	12/240

Glass cutter



NEW!



Screw open end cover



Put into handle kerosene or other suitable lubricants and screw tight cover

- ※ Tungsten carbide cutter wheel for sharpness and durability
- ※ Handle made of golden coloured aluminum

ITEM NO.	SIZE	BOX(CTN/PCS)
A0116	Aluminum handle	12/240

Professional pipe cutter



Cutting capacity: 3-42mm
Suitable for cutting ppr and pvc pipes



Conventional pull-open construction means near zero malfunction



Ratchet gear makes cutting easy and fast



Blade is made of choice stainless steel blade especially heat treated and tempered with a hardness of hrc55-58 stays sharp for much longer time than softer blades



Re-reinforced high quality aluminum body and all heat treated steel components greatly reduce the chances of distortion under pressure and long time use

MOST SUITABLE FOR CUTTING THICK AND HARD PIPES

ITEM NO.	SIZE	BOX(CTN/PCS)
A0104	3-42mm	10/60

Conduit pipe cutter



NEW!

**CUTTING CAPACITY:
3-30mm**



Wiring tubing

Hard pvc/ppr tubing

1. Blade made of choice stainless steel with special heat treatment stays sharp and operational for a long time
2. Aluminum handle and compact size, light to use and easy to carry

ITEM NO.	SIZE	BOX(CTN/PCS)
A0105	3-30mm	6/48

Heavy duty pvc pipe cutter



NEW!



FOR CUTTING PVC AND PPR PIPES

PVC/aluminum composite pipes are becoming more and more popular. This tool maybe the best choice for cutting this type of tubing



Easy to cut thick wall tubing as well



Patented multi-position pipe holder keeps even thin wall pipe in firm place without flattening it when cutting

CUTTING CAPACITY: 16-42mm

QUICK BLADE REPLACEMENT MACHINISM

※ Suitable for cutting ppr, pvc, pe and plastic composite tubing

※ Cutting capacity: 16, 20, 25, 32, 40mm dia. Tubing

Blade made of high quality stainless steel, hrc 56-58^o
Patented multi-position pipe holder keeps even thin wall pipe in firm place without flattening it when cutting

Ratchet gear for easy cutting

Patented quick blade changing mechanism without the need to use any tools

ITEM NO.	SPECS.	BOX(CTN/PCS)
A0106	3-42mm	6/48
A0106B	Spare blade	-/-

Heavy duty pvc pipe cutter



FOR CUTTING PVC AND PPR PIPES

• Heavy duty construction for cutting thicker pipes

ITEM NO.	SPECS.	BOX(CTN/PCS)
A1106	3-42mm	6/48
A1106B	Spare blade	-/-

PATENTED PIPE CUTTERS

- ※ Mini bearing rollers and unique gear box mechanism allows you to work with ease and joy
- ※ Blade made of choice alloy steel especially heat treated to stand heavy duty cutting work

A1404-75 CUTTING CAPACITY: 25-75mm/1"-3"

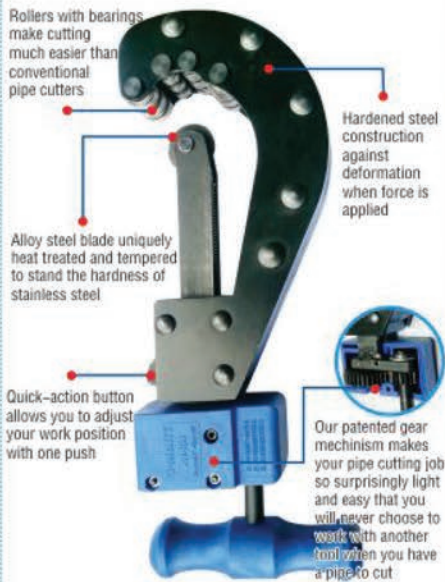

METAL PIPES

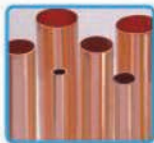

COPPER PIPES



ITEM NO.	SIZE	BOX(CTN/PCS)
A1404-75	25-75mm/1"-3"	6/48

A1704-75

CUTTING CAPACITY: 25-75mm / 1"-3"
FOR CUTTING PE, PVC, PPR AND COPPER TUBING

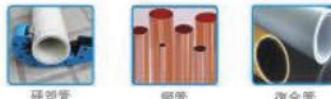

ITEM NO.	SIZE	BOX(CTN/PCS)
A1704-75	25-75mm	1/20

A1704-127

CUTTING CAPACITY: 50-127mm / 2"-5"
FOR CUTTING PE, PVC, PPR AND COPPER TUBING



ITEM NO.	SIZE	BOX(CTN/PCS)
A1704-127	50-127mm	1/20

A1704-160

CUTTING CAPACITY: 80-160mm / 3 1/8"-6 1/2"
FOR CUTTING PE, PVC, PPR AND COPPER TUBING



ITEM NO.	SIZE	BOX(CTN/PCS)
A1704-160	80-160mm	1/20

A0114

CUTTING CAPACITY: 3-16mm / 7/64-5/8"

FOR CUTTING COPPER TUBING



ITEM NO.	SIZE	BOX(CTN/PCS)
A1104	3-16mm	12/72

A1104

CUTTING CAPACITY: 3-30mm / 7/64-1 1/64"

FOR CUTTING STEEL AND COPPER TUBING



ITEM NO.	SIZE	BOX(CTN/PCS)
A1104	3-30mm	6/48



BLADES EASILY REPLACEABLE

ITEM NO.	SIZE
A1104B	3-30mm
A1204B	3-30mm
A1304B	6-36mm
A1404B	25-75mm
A1704B-75	25-75mm
A1704B-127	50-127mm
A1704B-160	80-160mm



HUBUNGI



JL.RAYA JANTI NO.96

YOGYAKARTA

(0274) 493 22 88

08112863773

(CHAT ONLY)

f qhomemart t qhomemart

@ qhomemart v qhomemart

WWW.QHOMEMART.COM