

# ACCESSORIES FOR DOOR & WINDOW



Hinge • Pull Handle • Lever Handle • Mortise • Cylinder



## THE MODERN LIFESTYLE OF DOOR & WINDOW

# ACCESSORIES



At Dekkson, we understand that every architectural project requires a different approach. That has been the principle that grounds us in providing the most effective and optimal architectural hardware solution to leading industry clients for more 25 years, combining unparalleled services and a wide range of quality product for every market segment. Through in-depth research, rigorous quality control process, and an architectural sensibility that balances between aesthetics and function, we can provide you with the same customized solutions to help you turn your vision into reality.

Starting its business in 1994, Dekkson has successfully widen its product range to cover hardware and accessories for wooden door, aluminium door, glass door, and window, in which all are qualified to meet various building requirements and standards.

Dekkson offers a full range of standardized and custom-made products that are constantly evolving, driven by our spirit of innovation. Every product is manufactured through an advanced manufacturing process and rigorous quality control process using only the highest quality of materials.

We'll help you come up with the best solution for the most optimal product use, most efficient budget, and longer lifetime. Combining a wide-range of high quality products and services that stretch throughout the product's lifetime, our solution is tailor made for your need, budget and market segment.

# TABLE OF CONTENT



<p><u>3</u></p> <p><b>Electronic Lock</b></p>	<p><u>49</u></p> <p><b>Cylinder</b></p>
<p><u>9</u></p> <p><b>Automatic Door System</b></p>	<p><u>52</u></p> <p><b>Entrance Handle</b></p>
<p><u>15</u></p> <p><b>Hinge</b></p>	<p><u>53</u></p> <p><b>Lockset Series</b></p>
<p><u>20</u></p> <p><b>Pull Handle</b></p>	<p><u>55</u></p> <p><b>Door Closer</b></p>
<p><u>30</u></p> <p><b>Lever Handle</b></p>	<p><u>57</u></p> <p><b>Acc. For Glass</b></p>
<p><u>38</u></p> <p><b>Lever Handle Plate</b></p>	<p><u>72</u></p> <p><b>Acc. For Aluminium</b></p>
<p><u>40</u></p> <p><b>Pull Plate</b></p>	<p><u>77</u></p> <p><b>Acc. For Wood</b></p>
<p><u>41</u></p> <p><b>Sign Plate</b></p>	<p><u>81</u></p> <p><b>Acc. For Sliding Door</b></p>
<p><u>42</u></p> <p><b>Escutcheon</b></p>	<p><u>84</u></p> <p><b>Acc. For Slide &amp; Fold Door</b></p>
<p><u>43</u></p> <p><b>The Series</b></p> <p>43 Neo Series</p> <p>44 Vintage Series</p> <p>45 Prestige Series</p> <p>46 Black Series</p>	<p><u>86</u></p> <p><b>Acc. For Furniture</b></p>
<p><u>47</u></p> <p><b>Mortise</b></p>	<p><u>89</u></p> <p><b>Acc. For Steel Door</b></p>

\* **DEKSON** reserves the rights to change the design & technical specifications of the products or to make additions or improvements without any notification. If you must form a complete sets for engineering. Please contact the local distributor or our company to inquire about the accurate sizes, or measure according to the sizes of the object itself.

\* Please refer to your associate sales person for further information related to this product.



# ELECTRONIC

# LOCK

"Modern Technology with  
Sophisticated Design"



**DEKSON**  
QUALITY IS THE KEY

**3 YEAR**  
MECHANICAL  
WARRANTY

**1 YEAR**  
ELECTRICAL  
WARRANTY



# ELECTRONIC LOCK

SEE THE FULL COLLECTION OF DEKSON ELECTRONIC LOCK AT OUR DEKSON ELECTRONIC LOCK BROCHURES



## STAND ALONE



**ELP 9519 MF FIN PASS 3D GREY**  
Available : Dummy For Passive Door



**ELP 9419 MF FIN PASS DV BLACK**  
Available : Dummy For Passive Door







**EL D-21 BLACK + SN**



**EC D-01 BLACK**

Available : • 70MM BLACK, SILVER  
• 80MM BLACK, SILVER



**SMART GLASS DOOR LOCK G01 BLACK R/L**



**EL 9113 MF FIN PASS BLACK**



**ELC 9318 SERIES**



**ELC 9318 MF PASS BT - W17 BLACK R/L**



**ELC 9318 MF PASS BT - W37 BLACK R/L**







**ELC 9318 MF PASS BT - A27 R/L**

Available : • Chrome Silver  
• Chrome Black



**ELC 9318 MF PASS BT - W03 BLACK**



**ELC 9318 MF PASS BT - R07 BLACK**



**ELC 9318 MF PASS BT - R37 BLACK**



**ELC 9318 MF PASS BT - RF08**



**MANY WAYS TO UNLOCK ELECTRONIC LOCK :**



**FINGERPRINT**



**PASSWORD**



**DEON SMART LIVING APP**

Available on:



**MIFARE CARD**



**MECHANICAL KEY**



**TTLOCK**

Available on:





# CARD LOCK HOTEL



CLH 2202 MF

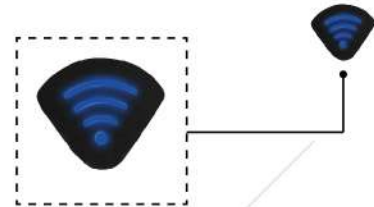

Include : MIFARE RECEIVER



CLH 2002 MF



CLH 2001 MF



CLH 2201 MF

## ELECTRONIC LOCK DOOR SWING DIRECTION

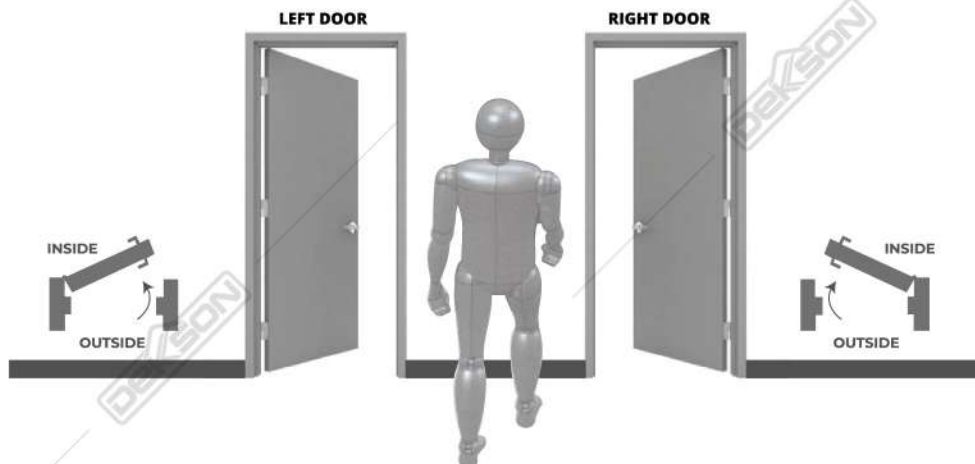

**AUTOMATIC DOOR SYSTEM**  
**DOOR CLOSER AUTOMATIC DCA-100**



**SPECIFICATION :**

Supply Voltase	100 - 240V
Power Consumption	50W
Opening Time	3 ~ 7 second / 90°
Hold Open Time	1 ~ 30 second (adjustable)
Door Width	Min. 550 mm / Max. 1200 mm
Door Weight	Max. 100 kg
Max. Opening Angle	105°
Environment Temperature	-20 C° ~ +50 C°
Protection Class	IP12D
Product Weight	6.5 Kg
Dimention	520x95x82 mm

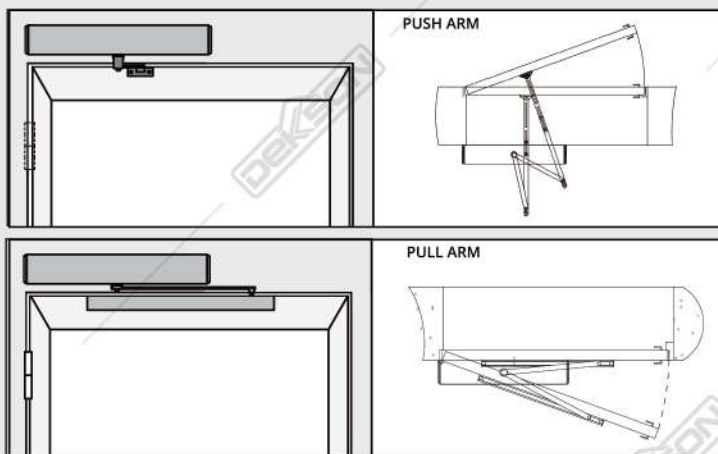

**BASE PLATE**



**OPERATOR**



**BOTTOM PLATE**



**COVER**



**PULL ARM**



**PUSH ARM**



**MOTOR SHAFT EXTEND**



**REMOTE CONTROL**



**ELC 9318 MF FIN PASS\*  
RF 08**



**EPB SS\***



**MOTION SENSOR\***



**WIRELESS PUSH BUTTON SWITCH\*  
WPB 807**

*\*accessories can be ordered separately*



# AUTOMATIC DOOR SYSTEM

## AUTOMATIC SLIDING DOOR ASD-D120B

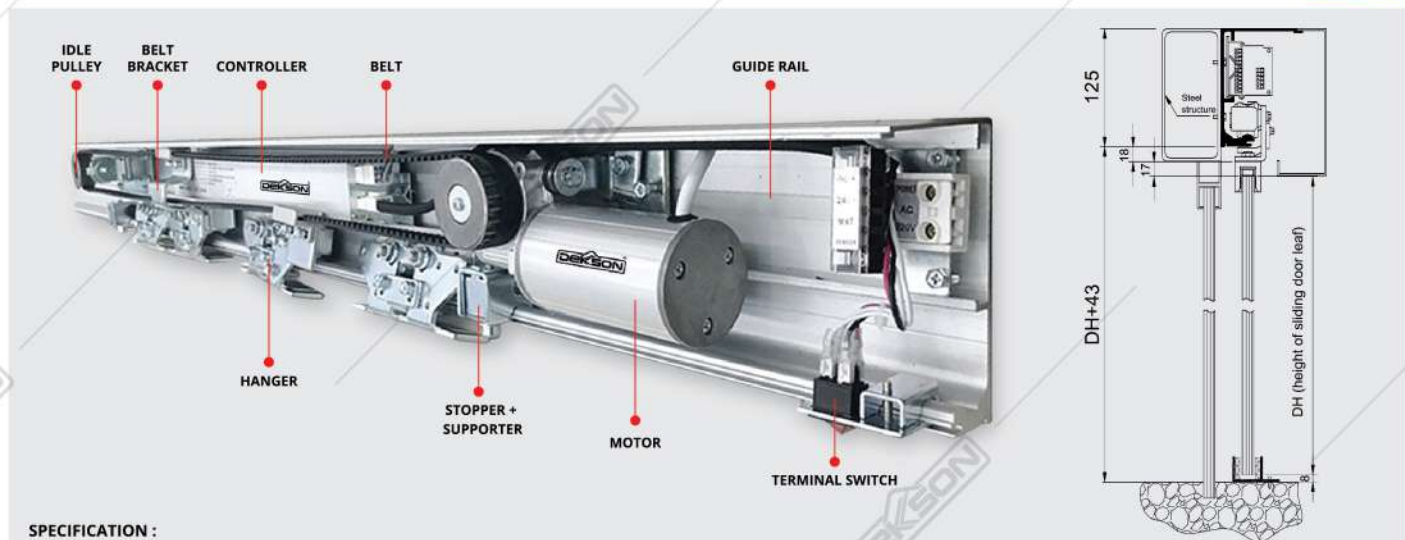

**SPECIFICATION :**

Door leaf	Single leaf	Double leaves
Weight of door leaf	Max. 150 kg	Max. 2 x 120kg
Width of door leaf	DW = 750 - 1600mm	DW = 650 - 1050mm
Width of door opening	W = Max. 1550mm	W = Max. 2000mm
Method of Installation	Surface Installation	
Supply power voltage	AC 110-220V±10%, 50/60 Hz	
Opening Speed	150-460mm/s (adjustable)	
Closing Speed	130-460mm/s (adjustable)	
Door hold-open time	0-8s (adjustable)	
Manual open/close force		
Motor	DC 24 V, 60~70W(DC, brushless)	
Working Environment temperature	-20°C~50°C	

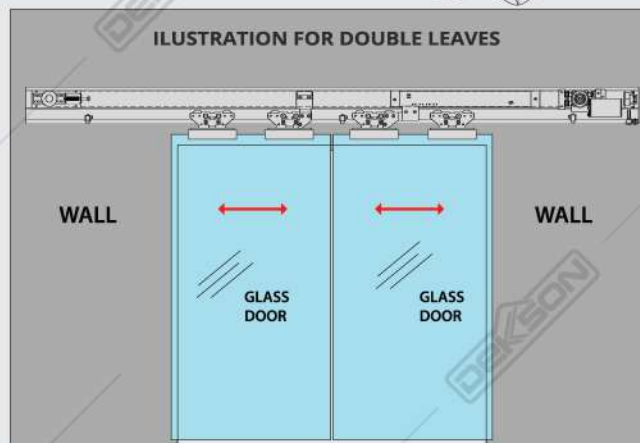

\*accessories can be ordered separately

# AUTOMATIC DOOR SYSTEM

## AUTOMATIC SLIDING GATE DAG-1000

**SPECIFICATION :**

Voltage	220 V/50 HZ
Motor Power	400 W
Maximum Loading Weight	1000 Kg
Maximum Width Gate	12 m (there is an increase in the number of tracks)
Gate Moving Speed	11 - 13 m / minutes
Remote Frequency	433.92 MHz
Remote Control Distance	≤ 30 m
Remote Control Mode	Single Button Mode / Four Button Mode
Working Noise	≤ 60 db

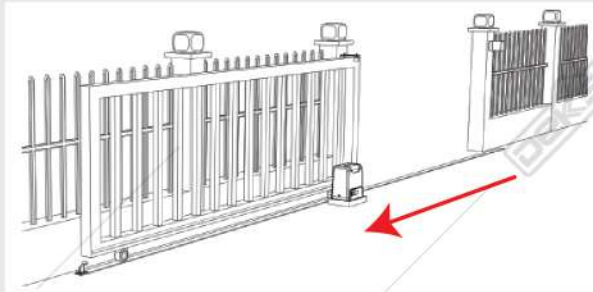

Gate in open position (from inside)

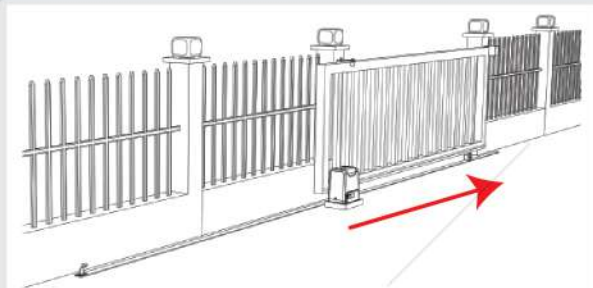

Gate in closed position

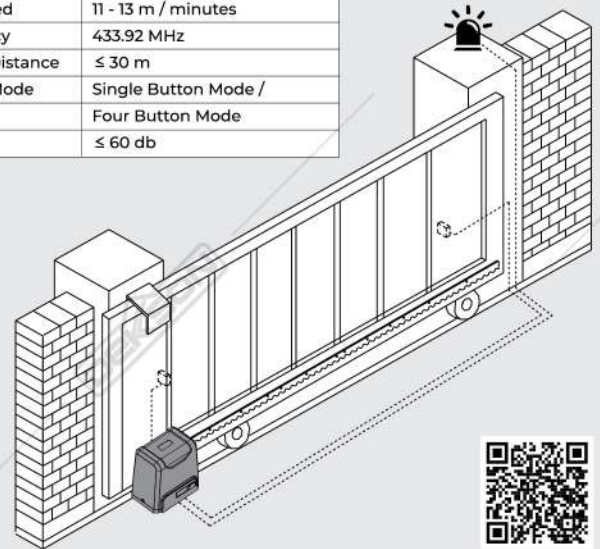

MOTOR (1 pc)



MOUNTING PLATE (1 pc)



INFRARED PHOTOCELL (1 set)



REMOTE CONTROL (2 pcs)



MANUAL RELEASE KEY (2 pcs)



WARNING LAMP 12V\* (1 pc)



EPB SS (1 pc)\*



MAGNETIC LIMIT SWITCH BRACKET (1 pc) + MAGNET COMPONENTS (2 pcs)



GALVANIZED GEAR RACK (4 pcs @1m / pc)\*

\*Additional unit available for purchase



ELC 9318 MF FIN PASS\* RF 08 (1 pc)

\*accessories can be ordered separately



# AUTOMATIC DOOR SYSTEM

## AUTOMATIC SWING GATE DAG-300 SW

**SPECIFICATION :**

Power Supply	220VAC/50Hz
Motor Power	50W
Swing Gate Moving Speed	18~22s / 90°
Max. Single Leaf Weight	300 Kg
Max. Single Leaf Length	2,5 M
Max. Piston Stroke	32 cm
Max. Force	2800N

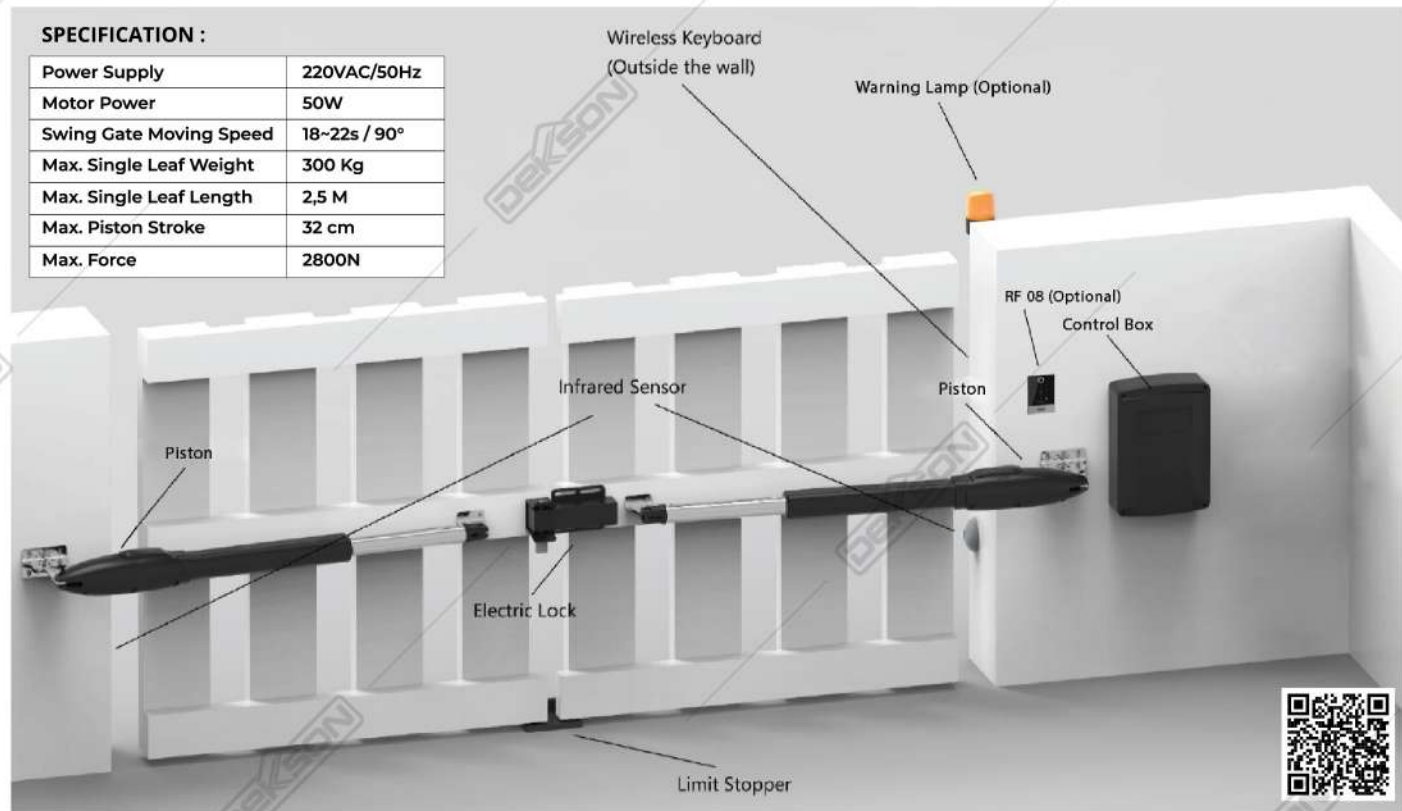

### DAG-300 SW DOUBLE

Available : DAG-300 SW Single



CONTROL BOX (1 pc)



PISTON (2 pcs)



WARNING LAMP 12V-220V\* (1 pc)



CONNECTOR BRACKET (2 pcs)



FRONT MOUNTING BRACKET (2 pcs)



WALL BRACKET (2 pcs)



LIMIT STOPPER (1 pc)



EPB SS (1 pc)\*



INFRARED PHOTOCCELL (1 set)



REMOTE CONTROL (2 pcs)



MANUAL RELEASE KEY (4 pcs)



ELC 9318 MF FIN PASS\* RF 08 (1 pc)

\*to be ordered separately



# AUTO MATIC DOOR SYS TEM

DEKSON  
QUALITY IS THE KEY

1 YEAR  
MECHANICAL  
WARRANTY

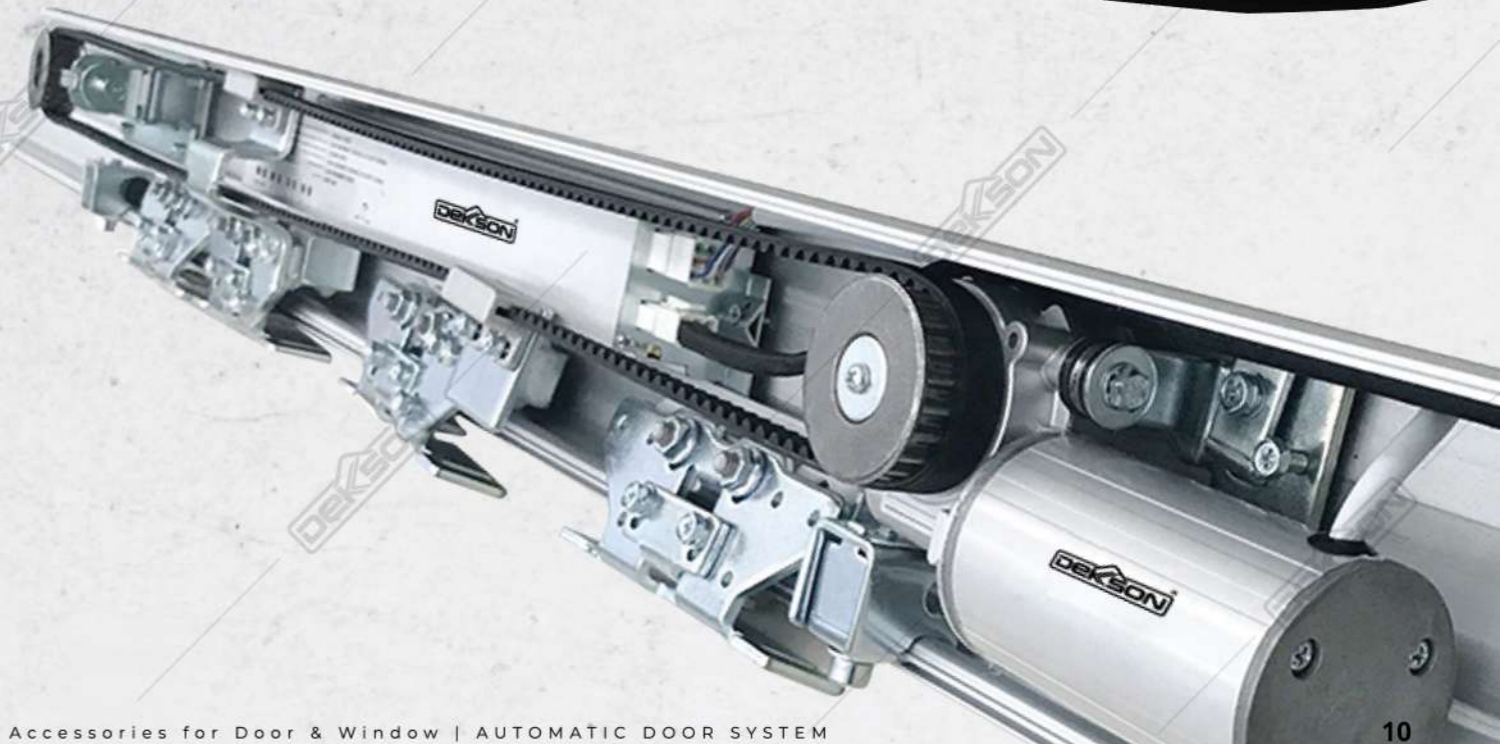
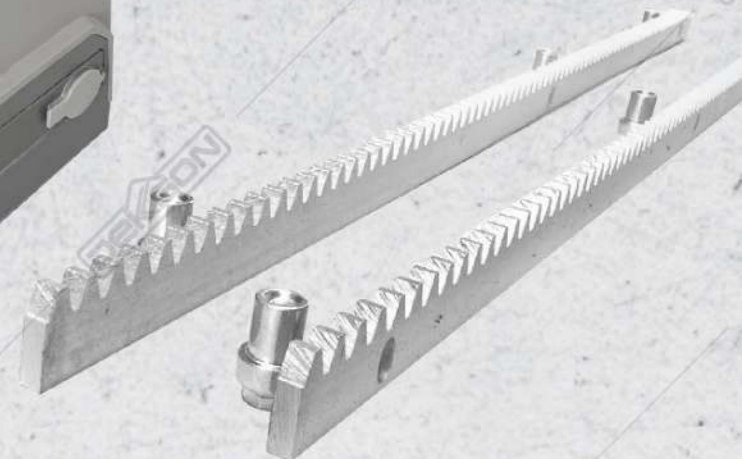



# HINGE



## HYDRAULIC HINGE

ES AL HYD 6,7X4,2X4MM  
MATT BLACK (2+1)  
Available : Left or Right  
ES AL HYD 6,7X4,2X4MM GREY (2+1)  
Available : Left or Right



Max. Door Weight : 80 Kg / Set  
Max. Door Width : 800 mm

## SPECIAL PURPOSE HINGE



**HYDRAULIC HINGE**  
ESS HYD 6,2X4X3MM SSS  
Available : Left or Right  
Capacity (max) : 60 KG / pair



**DOUBLE ACTION SPRING HINGE**  
ESS SPR 3" SSS  
Capacity (max) : 10 KG / pair



**DOUBLE ACTION SPRING HINGE**  
ESS SPR 4" SSS  
Capacity (max) : 12 KG / pair



**SPRING HINGE**  
ESS SPR 4X3X3MM SSS  
Available : 4X4X3MM SSS  
Capacity (max) : 30 KG / pair  
Max Door Width : 80 cm  
(Not suitable to be applied to hotel lock doors)



**SAFE GUARD HINGE**  
ESS SGH 4X3X3MM 2BB SSS  
Capacity (max) : 75 KG / pair



**HINGE "H"**  
ESS EL "H" 4X3X2MM 2BB SSS  
Capacity (max) : 30 KG / pair



**GRAVITY HINGE**  
ESS LOH 4X3X2MM SSS  
Capacity (max) : 30 KG / pair



**ALUMINIUM HINGE**  
ES AL 2005 4X3,5X3MM NA  
Available : BK, WH, YB1C  
Capacity (max) : 40 KG / pair



**ALUMINIUM HINGE**  
ES AL 0940 BK  
Available : NA, DB, WH  
Capacity (max) : 40 KG / pair

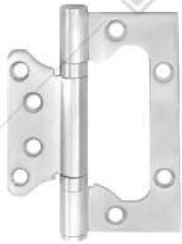

**ONE LEAF HINGE**  
ESS DL OL 4X3X2MM 2BB SSS\*  
Capacity (max) : 15 KG / pair



**FLAG HINGE**  
ESS FH 127X63X3MM 1W SSS  
Capacity (max) : 50 KG / pair



**STEEL DOOR HINGE**  
ES IR 34X90-39X90 GALV  
Capacity (max) : 100 KG / pair



**STEEL DOOR HINGE**  
ES IR 64X90-39X90 GALV  
Capacity (max) : 100 KG / pair



**THREE LEAF HINGE**  
TLH BR 180X63,7X7,5MM 2B CF\*  
Capacity (max) : 150 KG / pair

**CONCEALED HINGE**



**CONCEALED HINGE**  
ES CONC D40 MATT BLACK  
Available : NA  
Capacity (max) : 40 KG / pair  
Max. Door Width: 80 cm  
Opening Angle : ≤ 150°



**CONCEALED HINGE**  
ES CONC D80 NA  
Available : Matt Black  
Capacity (max) : 80 KG / pair  
Max. Door Width: 90 cm  
Opening Angle : ≤ 150°



**CONCEALED HINGE**  
ES CONC D120 MATT BLACK  
Available : NA  
Capacity (max) : 120 KG / pair  
Max. Door Width: 90 cm  
Opening Angle : ≤ 150°



**CONCEALED HINGE**  
ESS CONC D100 SSS  
Capacity (max) : 90 KG / pair  
Max. Door Width: 100 cm  
Opening Angle : ≤ 150°



**CONCEALED HINGE**  
ESS CONC GD100N SSS  
Capacity (max) : 100 KG / pair  
Max. Door Width: 90 cm  
Opening Angle : ≤ 150°

**PIVOT HINGE**



**FPB DL 05**  
Capacity (max) : 200 KG / set  
\*Accessories FH Stang and Top Pivot to be ordered separately



**ESS PV 001 SSS**  
Capacity (max) : 50 KG / pair

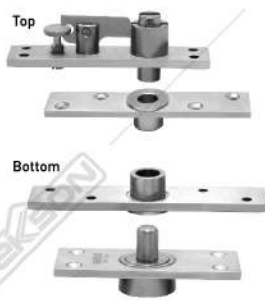

**ESS PV 002 SSS**  
Capacity (max) : 250 KG / set



**OFFSET PIVOT HINGE**  
ESS OPH 120 SS+ST LEFT  
Capacity (max) : 120 KG / set  
\*Available in RIGHT



**DPH 0980 NA**  
Capacity (max) : 80 Kg  
Door Width : 800 - 950 mm  
Door Thickness (min) : 45 mm  
Suitable For Indoor Use





**HI - GRADE HINGE SUS 316**

Material : Stainless Steel SUS 316

**LIFETIME**  
*Warranty*  
for Mechanical Only

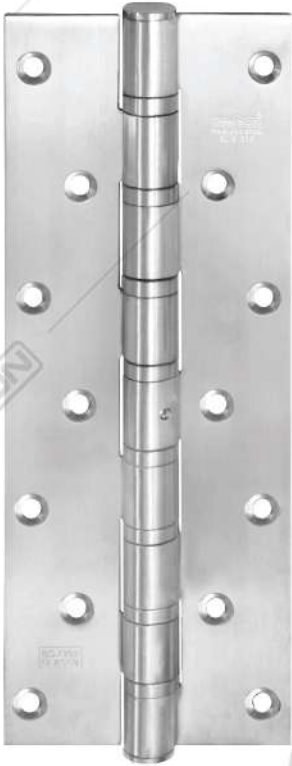

**NRP ESS 316**  
**12X4X4MM 8BB SSS**  
Capacity (max) : 150 KG / pair

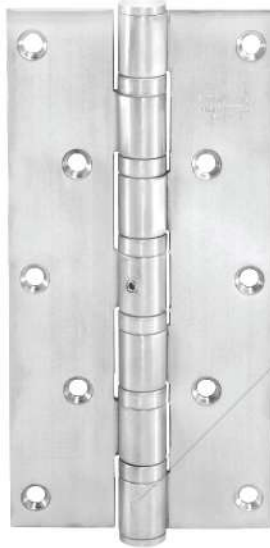

**NRP ESS 316**  
**8X4X4MM 6BB SSS**  
Capacity (max) : 120 KG / pair



**NRP ESS 316**  
**6X3,5X4MM 4BB SSS**  
Capacity (max) : 100 KG / pair



**NRP ESS 316**  
**3X2,5X2,5MM 2BB SSS**  
Capacity (max) : 32,5 KG / pair



**ESS 316**  
**4X3X2MM 2BB SSS**  
Capacity (max) : 40 KG / pair



**NRP ESS 316**  
**4X3X4MM 4BB SSS**  
Capacity (max) : 80 KG / pair



**NRP ESS 316**  
**5X3X4MM 4BB SSS**  
Capacity (max) : 90 KG / pair

**DELUXE HINGE**

Material : Stainless Steel SUS 304



**ESS DL**  
**3X2,5X2MM SSS**  
Capacity (max) : 30 KG / pair



**ESS DL**  
**3X2,5X2MM 2BB MATT BLACK**  
Available: SSS  
Capacity (max) : 30 KG / pair

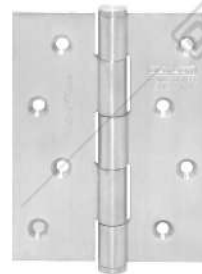

**ESS DL**  
**4X3X2MM SSS**  
Capacity (max) : 40 KG / pair



**ESS DL**  
**4X3X2MM 2BB SSS**  
Available: MATT BLACK  
Capacity (max) : 40 KG / pair

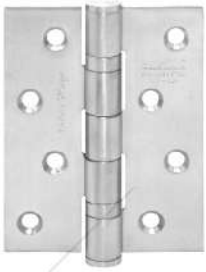

**ESS DL**  
**4X3X3MM 2BB SSS**  
Capacity (max) : 75 KG / pair



**ESS DL**  
**4X3X3MM 2BB MATT BLACK**  
Capacity (max) : 75 KG / pair



**ESS DL**  
**4X4X3MM 2BB SSS**  
Capacity (max) : 75 KG / pair



**ESS DL**  
**5X3X3MM 4BB MATT BLACK**  
Available : SSS  
Capacity (max) : 80 KG / pair

## NRP HINGE

Material : Stainless Steel SUS 304



**NRP ESS DL**  
**3X2,5X2,5MM 2BB SSS**  
Capacity (max) : 32,5 KG / pair

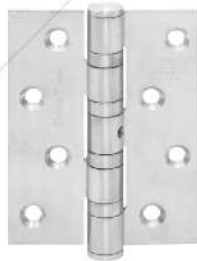

**NRP ESS DL**  
**4X3X3MM 4BB SSS**  
Capacity (max) : 75 KG / pair  
Available: 4X3X4MM 4BB SSS  
Capacity (max) : 80 KG / pair



**NRP ESS DL**  
**5X3X3MM 4BB SSS**  
Capacity (max) : 80 KG / pair  
Available: 5X3X4MM 4BB SSS \*  
Capacity (max) : 90 KG / pair



**NRP ESS DL**  
**6x3,5x3MM 4BB SSS**  
Capacity (max) : 90 KG / pair

## ECOLINE HINGE

Material : Stainless Steel

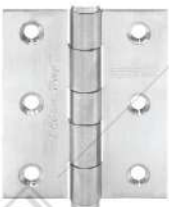

**ESS EL**  
**3X2,5X2MM SSS**  
Capacity (max) : 30 KG / pair

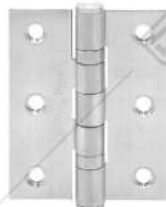

**ESS EL**  
**3X2,5X2MM 2BB SSS**  
Capacity (max) : 30 KG / pair



**ESS EL**  
**3X2,5X2MM 2BB TP**  
Capacity (max) : 30 KG / pair



**ESS EL**  
**4X3X2MM SSS**  
Capacity (max) : 40 KG / pair

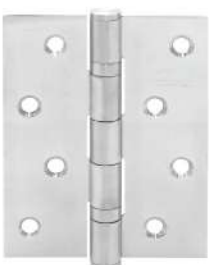

**ESS EL**  
**4X3X2MM 2BB SSS**  
Capacity (max) : 40 KG / pair



**ESS EL**  
**4X3X3MM 2BB SSS**  
Capacity (max) : 75 KG / pair



**ESS EL**  
**4X3X3MM 4BB SSS**  
Capacity (max) : 75 KG / pair



**ESS EL**  
**4X3X3MM 4BB TP**  
Capacity (max) : 75 KG / pair



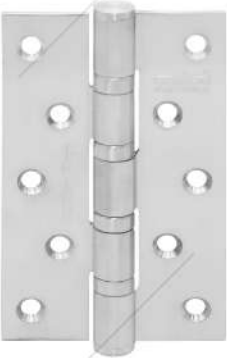

**ESS EL**  
**5X3X3MM 4BB SSS**  
Capacity (max) : 80 KG / pair



**ESS EL**  
**5X3X3MM 4BB TP**  
Capacity (max) : 80 KG / pair

**IRON HINGE**

Material : Iron



**ES IR**  
**3X2,5X2,5MM 2BB GP**  
Available : SN, CP  
Capacity (max) : 32,5 KG / pair



**ES IR**  
**4X3X3MM 4BB CP**  
Available : SN, GP  
Capacity (max) : 75 KG / pair



**ES IR**  
**5X3X3MM 4BB SN**  
Available : CP, GP  
Capacity (max) : 80 KG / pair

**NYLON IRON HINGE**

Material : Iron



**NYLON ES IR**  
**3X2,5X2MM 4NR NA**  
Capacity (max) : 30 KG / pair



**NYLON ES IR**  
**3X2,5X2MM 4NR BA**  
Capacity (max) : 30 KG / pair



**NYLON ES IR**  
**3X2,5X2MM 4NR WH**  
Capacity (max) : 30 KG / pair



**NYLON ES IR**  
**3X2,5X2MM 4NR BK**  
Capacity (max) : 30 KG / pair



**NYLON ES IR**  
**4X3X2MM 4NR NA**  
Capacity (max) : 40 KG / pair



**NYLON ES IR**  
**4X3X2MM 4NR BA**  
Capacity (max) : 40 KG / pair

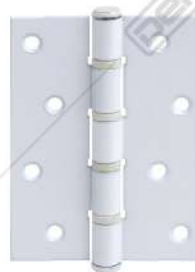

**NYLON ES IR**  
**4X3X2MM 4NR WH**  
Capacity (max) : 40 KG / pair



**NYLON ES IR**  
**4X3X2MM 4NR BK**  
Capacity (max) : 40 KG / pair

# PULL HANDLE



## PH DL801 SERIES

**PH DL801**  
**32X332X300 PSS**

Available :

- 25X225X200 PSS
- 32X382X350 PSS
- 32X432X400 PSS
- 32X482X450 PSS
- 32X532X500 PSS
- 32X632X600 PSS

## FOR GLASS & WOODEN DOOR

### PH DL801 SERIES

Material : Stainless Steel SUS 304

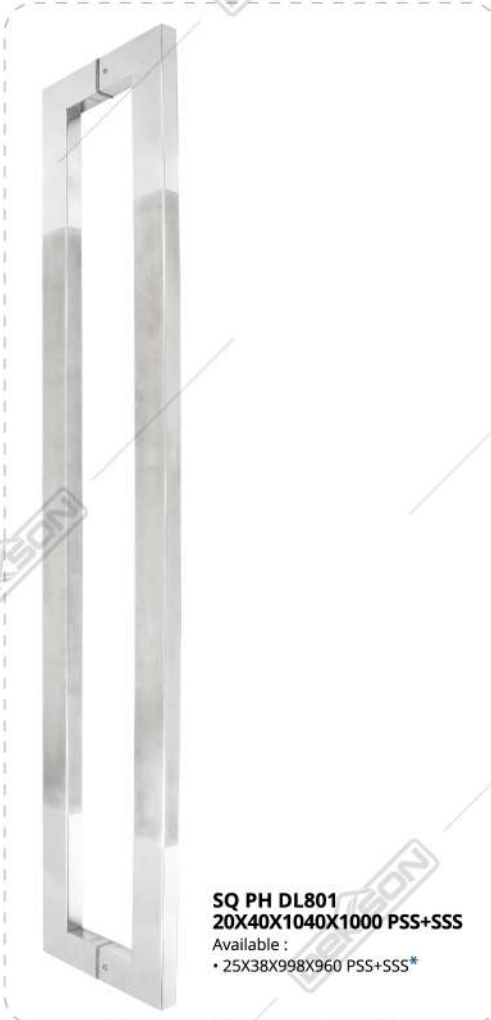

**SQ PH DL801**  
**20X40X1040X1000 PSS+SSS**  
Available :  
• 25X38X998X960 PSS+SSS\*



**PH DL801**  
**25X325X300 WHITE**

Available :

- 32X382X350 WHITE



**SQ PH DL801**  
**30X15X365X350 WHITE**

Available :

- 40X20X620X600 WHITE



**SQ PH DL801**  
**30X15X365X350 SSS**

Available :

- 30X15X615X600 SSS
- 30X15X465X450 SSS
- 40X15X1240X1200 SSS



**PH DL801**  
**25X325X300 MATT BLACK**

Available :

- 32X382X350 MATT BLACK



**SQ PH DL801**  
**30X15X365X350 MATT BLACK**

Available :

- 40X20X620X600 MATT BLACK
- 40X20X1020X1000 MATT BLACK



**SQ PH DL801**  
**30X15X365X350 BROWN**



**PH DL802 SERIES**

Material : Stainless Steel SUS 304



**PH DL802  
38X1600X1200 PSS**

Available :

- 25X400X300 PSS+SSS
- 25X475X300 PSS+SSS
- 25X425X285 PSS+SSS
- 32X450X300 PSS+SSS\*
- 32X457X300 PSS+SSS
- 32X500X300 PSS
- 32X500X300 PSS+SSS
- 32X600X400 SSS
- 32X600X400 PSS
- 32X600X400 PSS+SSS
- 32X800X600 PSS+SSS
- 38X1000X800 SSS
- 38X1000X800 PSS
- 38X1000X800 PSS+SSS
- 38X1200X800 SSS
- 38X1200X800 PSS
- 38X1200X800 PSS+SSS
- 38X1600X1200 SSS
- 38X2000X1500 PSS



**PH 802 OVAL  
30X20X600X400 SSS**



**SQ PH DL802  
30X15X600X400 SSS**

Available :

- 30X15X450X300 SSS
- 30X15X450X300 PSS
- 30X15X600X400 PSS



**PH DL802  
32X800X600 MATT BLACK**

Available :

- 38X1200X800 MATT BLACK



**PH DSQ 802  
30X15X450X600 SSS**

**PH DL809 SERIES**

Material : Stainless Steel SUS 304



**PH DL809  
32X382X350 WHITE**

Available :

- 25X325X300 WHITE



**PH DL809  
32X382X350 MATT BLACK**

Available :

- 25X325X300 MATT BLACK



**PH DL809  
32X382X350 PSS**

Available :

- 32X332X300 PSS



**SQ PHR 809  
30X15X380X350 WHITE**

Available :

- 40X20X640X600 WHITE



**SQ PHR 809  
30X15X380X350 MATT BLACK**

Available :

- 40X20X640X600 MATT BLACK



**PH DL809  
32X382X350 SSS**

Available :

- 32X332X300 SSS

**PH DL828 SERIES**

Material : Stainless Steel SUS 304



**PH DL828**  
**25X325X300 WHITE**  
Available :  
• 32X432X400 WHITE



**PH DL828**  
**25X325X300 MATT BLACK**  
Available :  
• 32X432X400 MATT BLACK



**PH DL828**  
**25X325X300 BROWN**  
Available :  
• 32X432X400 BROWN

Material : Stainless Steel SUS 304



**PH DL804**  
**32X332X300 PSS**



**PH SQ804**  
**15X30X400X200 SSS**



**PH BS 215**  
**18X215X175 SSS**



**PH 146**  
**25X540X500 PSS+SSS**  
Available :  
• 25X340X300 PSS+SSS



**PH DL441**  
**20X38X600X425 PSS+SSS**  
Available :  
• 20X38X800X625 PSS+SSS



**PH DL446**  
**32X600X400 SSS**  
Available :  
• 32X400X250 SSS  
• 32X800X600 SSS



**PH DL810**  
**38X800X600 PSS+SSS**  
Available :  
• 38X600X400 PSS+SSS  
• 38X1000X800 PSS+SSS



**PH DL815**  
**40X20X640X600 SSS**  
Available :  
• 40X20X640X600 PSS  
• 25X19X340X300 SSS



**PH DL816**  
**15X30X660X600 SSS**  
Available :  
• PH 816 15X30X660X600 PSS





**PH DL854**  
**25X45X800X600 PSS+ SSS**  
Available :  
• 25X45X1200X800 PSS+SSS



**PH DL876**  
**30X30X500X460 PSS+SSS**  
Available :  
• 25X25X400 PSS+SSS



**PH DL956**  
**38X600X450 PSS+SSS**  
Available :  
• 32X450X350 PSS+SSS



**PH DL 981**  
**33X13X450X400 PSS+SSS**  
Available :  
• 40X20X630X600 PSS+SSS  
• 40X20X800X600 PSS+SSS



**PH DL1830**  
**32X500X260 PSS+SSS**



**PH 1831**  
**32X500X235 PSS+SSS**  
Available :  
• 25X500X235 PSS+SSS



**PH DL1838**  
**32X640X610 PSS+SSS**



**PH DL1839**  
**38X560X250 PSS+SSS**



**PH DL1844**  
**30X15X500X375 PSS+SSS**



**PH DL1868**  
**40X25X600X420 PSS+SSS**  
Available :  
• 40X25X1200X760 PSS+SSS



**PH DL2141**  
**32X600X400 PSS+SSS**

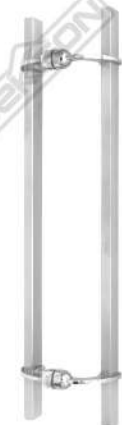

**SQ PH DL2141**  
**40X20X800X600 PSS+SSS**



**PH DL3111**  
32X500X400 PSS+ SSS



**PH DL8011**  
30X15X450X435 SSS  
Available :  
• 30X15X450X435 PSS  
• 30X15X465X450 SSS  
• 30X15X465X450 PSS



**PH DL8012**  
30X10X550X520 SSS  
Available :  
• 30X10X550X520 PSS



**PH DL8663**  
15X30X536X500 PSS+SSS



**PH DL8664**  
25X540X500 PSS+SSS



**PH DL8980**  
47X16X550X360 PSS+SSS



**PH DL8981**  
47X16X530X360 PSS+SSS



**PH DL8982**  
40X20X540X500 PSS



**PH DL8983**  
40X15X540X500 SSS



**PH DL8898**  
38X800X600 PSS + SSS  
Available :  
• 32X350X200 PSS+SSS  
• 32X500X300 PSS+SSS  
• 38X1200X800 PSS+SSS



**PH DL8899**  
38X800X600 PSS + SSS  
Available :  
• 32X350X200 PSS+SSS  
• 32X500X300 PSS+SSS  
• 38X1200X800 PSS+SSS



**PH 1880**  
FFX497X430 SSS





**PH DL8114**  
38X1200X600 PSS+SSS



**TPH 817**  
32X1200X1153  
GLASS SSS+PSS

Material : Zinc



**PH D8400**  
45X405X285 AT



**PH D8327**  
FFX420X327 AT



**PH D8437**  
FFX550X437 AT



**PH D8420**  
60X420X308 AT



**PH D8460**  
55X470X390 AT



**PH DL268**  
40X20X800X600  
SSS+WOOD



**PH 80243**  
32X800X600 PSS+WOOD  
Available :  
• 32X350X250 PSS+WOOD  
• 32X600X400 PSS+WOOD



**PH 810247**  
38X600X400 PSS+WOOD  
Available :  
• 32X350X250 PSS+WOOD



**PH SQ 80243**  
38X25X600X400 PSS+WOOD  
Available :  
• 38X25X350X250 PSS+WOOD



**PH SQ 80247**  
38X25X600X400 PSS+WOOD  
Available :  
• 38X25X350X250 PSS+WOOD



**PH 80247**  
32X600X400 PSS+WOOD  
Available :  
• 32X350X250 PSS+WOOD  
• 32X800X600 PSS+WOOD



**PH DL8750247**  
25X38X600X562 PSS+WOOD  
Available :  
• 25X38X350X312 PSS+WOOD



**PH DL351**  
25X400X375 SSS+WOOD



**PH 810243**  
32X350X250 PSS+WOOD  
Available :  
• 38X600X400 PSS+WOOD



**PH DL8750243**  
25X38X350X312 PSS+WOOD  
Available :  
• 25X38X600X562 PSS+WOOD





**PH EL801**  
**32X332X300 PSS**

- Available :
- 25X225X200 PSS
  - 32X382X350 PSS
  - 32X482X450 PSS
  - 32X532X500 PSS
  - 32X632X600 PSS



**PH EL802**  
**32X457X300 PSS+SSS**

- Available :
- 32X500X300 PSS
  - 32X600X400 PSS+SSS



**PH EL809**  
**32X332X300 PSS**

- Available :
- 32X382X350 PSS



**PH 262 ECOLINE**  
**30X20X300X180 PSS+SSS**

- Available :
- 30X20X400X250 PSS+SSS



**PH 263 ECOLINE**  
**30X15X300X180 PSS+SSS**

- Available :
- 30X15X400X250 PSS+SSS



**PH 266 ECOLINE**  
**30X20X300X180 PSS+SSS**

- Available :
- 30X20X400X250 PSS+SSS



**PH 269 ECOLINE**  
**30X15X300X180 PSS+SSS**

- Available :
- 30X15X400X250 PSS+SSS



**PH EL830**  
**32X400X200 PSS+SSS**

- Available :
- 25X300X150 PSS+SSS



**PH EL831**  
**32X400X250 PSS+SSS**

- Available :
- 25X300X200 PSS+SSS



**PH EL832**  
**32X400X250 PSS+SSS**

- Available :
- 25X300X200 PSS+SSS



**PH EL 2956**  
**32X450X350 PSS+SSS**



**EL SQ PH 809**  
**15X30X615X600 SSS**

**FOR WOODEN DOOR**

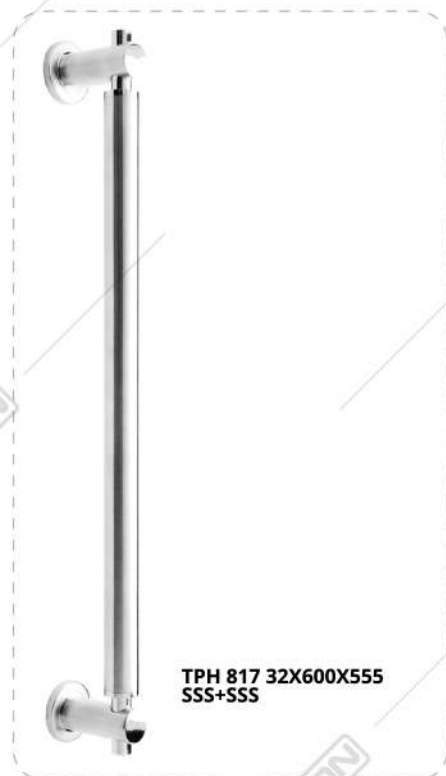



**FOR SHOWER DOOR**

Material : Stainless Steel SUS 304

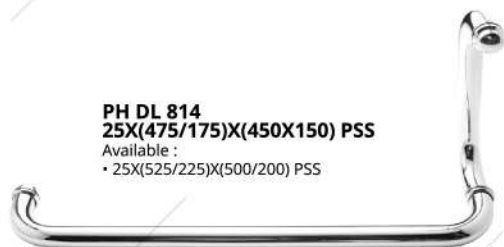

**PH DL 814**  
25X(475/175)X(450X150) PSS  
Available :  
• 25X(525/225)X(500/200) PSS



**PH DL 814**  
25X(525/225)X(500/200) MATT BLACK



**PH DL 814 SQ**  
19X19X(519/219)X(500X200) PSS  
Available :  
• 25X25X(525/225)X(500X200) PSS

**ECOLINE**



**PH EL 814**  
25X(475/175)X(450X150) PSS  
Available :  
• 25X(525/225)X(500/200) PSS

**FOOT PULL DOOR OPENER**



**FPD AL 853**  
127X76,5X3,5 NA



**FPD AL 853**  
127X76,5X3,5 BK



**FPD AL 853**  
127X76,5X3,5 A. COPPER

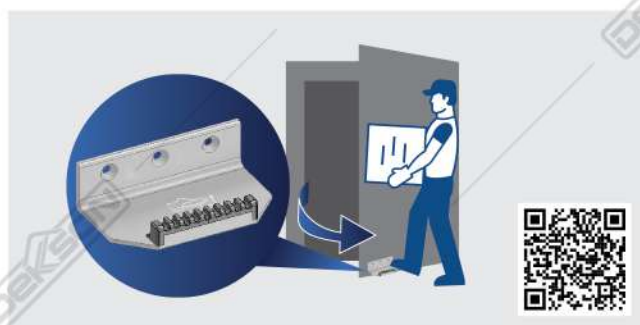

# LEVER HANDLE



LHSR 0011 SSS

## LEVER HANDLE SOLID ROSES (LHSR)

Material : Stainless Steel SUS 304



LHSR 0016 22MM SSS



LHSR 0039 SSS



LHSR 0040 SSS



LHSR 0049 SSS



LHSR 0049 OVAL SSS\*



LHSR 0051 SSS + PSS



LHSR 0056 SSS



LHSR 0058 SSS



LHSR 0061 SSS





LHSR 0085 SSS



LHSR 0132 SSS



LHSR 0138 SSS



LHSR 0139 SSS



LHSR 0142 SSS



LHSR 0216 SSS



LHSR 0217 SSS



LHSR 0238 SSS



LHSR 0309 SSS



LHSR 0406 SSS  
Available : PSS



LHSR 0506 SSS

## LEVER HANDLE TUBE ROSES (LHTR)

Material : Stainless Steel SUS 304



LHTR 001 SSS



LHTR 0003 SSS  
Available : MATT BLACK



LHTR 0014 SSS



LHTR 0015 SSS



LHTR 0016 19MM SSS  
Available : 22MM SSS



LHTR 0017 SSS  
Available : MATT BLACK



LHTR 0018 SSS



LHTR 0019 SSS + PSS  
Available : MATT BLACK



LHTR 0020 SSS + PSS



LHTR 0035 SSS



LHTR 0039 SSS  
Available : MATT BLACK



LHTR 0039 SQ SSS  
Available : MATT BLACK



LHTR 0041 SSS



LHTR 0043 SSS



LHTR 0044 SSS



LHTR 0049 SSS



LHTR 0051 SSS + PSS



LHTR 0056 SSS



LHTR 0058 SSS



LHTR 0064 SSS + PSS



LHTR 0085 SSS



LHTR 0101 SQ SSS



LHTR 0102 SQ SSS



LHTR 0103 SQ SSS + PSS





LHTR 0104 SSS



LHTR 0105 SSS + PSS



LHTR 0108 SQ SSS + PSS



LHTR 0110 SSS



LHTR 0142 SSS



LHTR 0146 SSS



LHTR 0218 SSS + CP



LHTR 0222 SQ SSS



LHTR 0238 SSS



LHTR 0507 SSS + PSS



LHTR 0803 SSS



LHTR 0805 SSS



LHTR 0806 SSS



LHTR 0811 SSS



LHTR 0812 SSS



LHTR 0813 SSS



LHTR 0819 SSS  
Available : MATT BLACK



LHTR 0820 SSS  
Available : MATT BLACK



LHTR 0821 SSS



LHTR 0822 SSS



LHTR 0823 SSS



**LHTR 0824 SSS**



**LHTR 0825 SSS**



**LHTR 0826 SSS**



**LHTR 0828 SSS**



**LHTR 8012 SSS**



**LHTR 8013 SSS**



**LHTR 0017 OVAL SSS**  
Available : MATT BLACK



**LHTR 0039 OVAL SSS**  
Available : MATT BLACK



**LHTR 0820 OVAL SSS**  
Available : MATT BLACK



**LHTR 84030 OVAL SSS**  
Available : MATT BLACK



**LHTR 0822 LSQ SSS**  
Available : LHTR 08222 SQ MATT BLACK



**LHTR 0016 22MM + KNOB SSS**

## LEVER HANDLE ROSES (LHR)



**LHR 0816 NA**  
Available : • BK • YB1C  
• PSS



**LHR 1041 SN + NP**



**LHR 2001 AZ SN + NP**  
Available : MATT BLACK



**LHR 2007 SN + NP**



**LHR 2009 AZ SN + NP**



**LHR 2017 AZ SN + NP**





LHR 2022 SN + NP



LHR 2028 AZ SN + NP



LHR 2030 AZ SN + NP



LHR 2035 SN



LHR 2048 SN



LHR 2073 SN + NP



LHR 2068 AZ SN + NP



LHR 2095 SN + NP  
Available : MATT BLACK



LHR 2099 SN + NP



LHR 2110 SN + NP



LHR 2115 SN



LHR 21182 CP



LHR 2192 SN + CP



LHR 2213 CP



LHR 2216 SN + CP



LHR 2217 SN + CP



LHR 2223 SN + NP



LHR 2232 CP



LHR 2237 SN + NP



LHR 2257 SN + NP



LHR 2282 CP



**LHR 2285 SN + CP**



**LHR 2287 SN**



**LHR 2291 SN + NP**  
Available : GP + BSG



**LHR 2293 CP**



**LHR 2295 SN + CP**



**LHR 2668 SN + NP**



**LHR 2688 SN + NP**



**LHR 2897 SN + NP**



**LHR 2956 SN**



**LHR 2967 SN**



**LHR 2970 SN**



**LHR 5028 AZ SN + NP**



**LHR 5061 SN + NP**



**LHR 5208 SN + CP**



**LHR 5218 SN + NP**  
Available : MATT BLACK



**LHR 5230 SC + CP**



**LHR 5672L CP + PPDW**  
Available : CP+PPCR



**LHR 5830 SN + NP**



**LHR 5895 SN + NP**



**LHR 7580 CF**



**LHR 8267 MAB**



LHR 8288 MAB



LHR 8536 CF



LHR 9219 SN + CP



LHR 9568 SN + NP



LHR 9818 MAB



LHR 9889 SN + NP



LHR 9891 SN + NP



LHR 9908 SN + NP



LHR 9911 SN + NP



LHR 9961 SN + NP



LHR 9962 SN + NP



LHR 9986 SC + CP



LHR 10632 MAB



LHR 10681 MAB



LHR 10693 CF



LHR 21037 CP



LHR 22885 MAB



LHR 631203 MBSN  
Available : • CP  
• MATT BLACK



LHR 81033 MAB



# LEVER HANDLE PLATE (LHP)



**LHP 2095 AB**  
Available : SN + NP



**LHP 1557 SN + NP**  
Available : AB



**LHP 1949 AB**  
Available : SN



**LHP 2009 AZ SN + NP**



**LHP 2028 AZ SN + NP**



**LHP 2208 SN + NP**



**LHP 2228 AZ SN + NP**



**LHP 2368 AZ SN + NP**



LHP 7662 SN + NP



LHP 11692 CF



LHP 11731 MAB  
Available : • CF  
• MATT BLACK



LHP 52228 MATT BLACK



LHP 81430 MATT BLACK  
Available : • NA  
• WH  
• YB1C



LHP 95580 CF



LHP 96536 CF



LHP T005 SSS



LHP T519 SSS + PSS\*



LHP T039 SQ SSS



LHP T104 SQ SSS



LHP T108 SQ SSS



LHP T822 SQ SSS



**PP 004 PVD**  
Available : • AB  
• SSS

# PULL PLATE



**PP 009 SSS**



**PP 006**  
WITH CYL HOLE SSS



**PP 012 AB**  
Available : • WH • YB1C  
• SSS • Matt Black  
• PVD



**PP 012 SSS 150MM SSS**  
Available : MATT BLACK\*



**PP 013 SSS**  
Available : PVD



**PP 015 SQ 115MM SSS**



**PP 015 SQ 150MM SSS**  
Available : MATT BLACK\*



# SIGN PLATE



**SP002D CYL SSS**



**SP002A SSS**  
Available : PVD



**SP002A PUSH PVD**  
Available : SSS



**SP003 HDL PVD**



**SP003 HDL  
+ CYL HOLE SSS**



**SP003 N HDL SSS**

# ESCUTCHEON



ESCN D13 SSS



ESCN 855 SSS / PSS



ESCN 855 AB



ESCN 855 PVD



ESCN 855 MATT BLACK



ESCN D01 SSS  
Available : MATT BLACK



ESCN D07 SSS



ESCN Z01 SN + NP



ESCN UKIR AT



ESCN SQ01 SSS



ESCN SQ01 MATT BLACK



ESCN SQ013 SSS



ESCN 84030 SSS  
Available : MATT BLACK



ESCN P04 SSS

# NEO SERIES

SEE THE FULL COLLECTION OF DEKSON NEO SERIES  
AT OUR DEKSON THE SERIES BROCHURES



LHP N43106 MAB

## LEVER HANDLE PLATE



LHP N01101 MSN



LHP N43110 MAB



LHP AL N0106 MSN

## LEVER HANDLE ROSES



LHR N46 MSN



LHR N101 MAB



LHR N105 MSN



# VINTAGE SERIES

SEE THE FULL COLLECTION OF DEKSON VINTAGE SERIES AT OUR DEKSON THE SERIES BROCHURES



PHZ V55168 GOLD

## CLASSIC SERIES



PULL HANDLE  
PHZ V5520 MAB



LEVER HANDLE  
LHP V207 1165 MCF



LHR V21726 PVD



ESCUTCHEON  
ESCN V55 24K GOLD

## GRAND SERIES



PULL HANDLE  
PHA V82080 MAB



PHA V82036 MBN



DOOR KNOB  
DKA V81590 MAC



DKA V81571 MBN

# PRESTIGE SERIES

SEE THE FULL COLLECTION OF DEKSON PRESTIGE SERIES  
AT OUR DEKSON THE SERIES BROCHURES



**PHA D319 ANTIQUE CHROME**  
**FFX299X271**  
Available : • SILVER  
• BLACK



**PHA D389 BLACK**  
**FFx378x346**  
Available : • SILVER  
• ANTIQUE CHROME



**PHA D300 SILVER**  
**31x332x299**  
Available : • BLACK  
• ANTIQUE CHROME



**PHA D400 BLACK**  
**31x432x401**  
Available : • SILVER  
• ANTIQUE CHROME



**PHA D216/280 ANTIQUE CHROME**  
**FFx284x258**  
Available : • SILVER  
• BLACK



**PHA D211/330 SILVER**  
**FFx330x292**  
Available : • BLACK  
• ANTIQUE CHROME



**PHA D217/330 ANTIQUE CHROME**  
**FFx330x302**  
Available : • SILVER  
• BLACK



**PHA D217/430 BLACK**  
**FFx430x401**  
Available : • SILVER  
• ANTIQUE CHROME

**BLACK  
SERIES**

# BLACK SERIES

SEE THE FULL COLLECTION OF DEKSON BLACK SERIES  
AT OUR DEKSON THE SERIES BROCHURES



**MTS RL DL8685  
MATT BLACK**



**LEVER HANDLE  
LHR 0829 MATT BLACK**



**LEVER HANDLE  
LHR 22-1021  
MATT BLACK + GOLD**



**LEVER HANDLE  
LHR 631120  
CP + MATT BLACK**



**LEVER HANDLE  
LHR V32818  
MATT BLACK COOPER**



**HINGE  
ESS DL 4X3X3MM 2BB  
MATT BLACK**



**CYLINDER  
CYL DC KK DL60MM MATT BLACK**



**ACCESSORIES  
SH DKS 7701 (GW) MATT BLACK**



**DOOR CLOSER  
DCL 300 NHO MATT BLACK**



# MORTISE LOCK

**LIFETIME**  
Warranty  
for Mechanical Only



**SWING / INTERLATCH**



**MTS IL DL 82585 SSS**



**MTS IL DL 83585 SSS**



**MTS IL DL 84030 SSS**  
Available : MATT BLACK \*



**MTS IL DL 8485 MATT BLACK**  
Available : • PVD  
• SSS  
• RAB



**MTS IL DL 8585 SSS**  
Available : • PVD  
• RAB  
• MATT BLACK

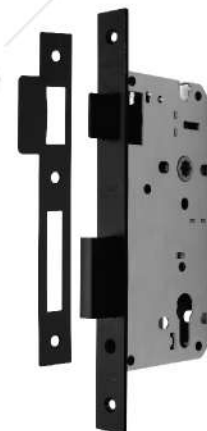

**MTS IL DL 8685 MATT BLACK**  
Available : • PVD  
• SSS

## ROLLER LATCH



**MTS RL DL 84030 SSS**  
Available : MATT BLACK



**MTS RL DL 83585 SSS**



**MTS RL DL 8485 PVD**  
Available : • SSS  
• MATT BLACK



**MTS RL DL 8585 MATT BLACK**  
Available : • PVD  
• SSS  
• RAB



**MTS RL DL 8685 SSS**  
Available : • PVD  
• MATT BLACK

## HEAVY DUTY



**MTS HD DL 8672 PANIC SSS**  
Available :  
• MTS HD DL8672 NON PANIC SSS

## HEAVY DUTY HI - GRADE

Material : Stainless Steel SUS 316



**MTS IL DL 8585 SSS**



**MTS RL DL 8585 SSS**

HEAVY DUTY

HIGH GRADE!

## MULTI POINT LOCK



**MPL 8685 1600MM SSS**

## SLIDING



**MTS SLD DL 8225 SSS**



**MTS SLD DL 83100 MATT BLACK**  
Available :  
• MTS SLD DL 83100 SSS  
• MTS SLD DL 85100 SSS  
• MTS SLD DL 85100 MATT BLACK



**MTS SLD DL 84100 SSS**  
Available : MATT BLACK



**MTS DB 40MM SSS**

# CYLINDER

**LIFETIME**  
Warranty  
for Mechanical Only



**CYL TC KK 60MM**  
**MATT BLACK**  
Available : 70MM

## CONSTRUCTION KEY



**CON CYL DC DL 62MM SN (2+3)**



**FIRST KEY (2 pcs)**



**FINAL KEY (3 Pcs)**



**FIRST KEY**  
Used during construction period.  
Cannot be used once Final Key is used.



**FINAL KEY**  
Used after construction is finished.  
Once Final Key is used, First Key is no longer operational.



## STANDARD CYLINDER

### DOUBLE CYLINDER



**CYL DC DL60MM SN**  
Available : • 50MM • 70MM • 120MM  
• 55MM • 80MM • 150MM  
• 65MM • 100MM • 180MM



**CYL DC DL60MM PB**



**CYL DC DL66MM AB**



**CYL DC DL60MM MATT BLACK**  
Available : • 65MM  
• 70MM

### THUMBTURN CYLINDER



**CYL TC DL60MM SN**  
Available : • 65MM • 70MM • 150MM  
• 80MM • 100MM  
• 180MM • 120MM



**CYL TC DL60MM PB**  
Available : 66MM AB



**CYL TC DL60MM MATT BLACK**  
Available : 70MM

### BATHROOM KEY CYLINDER



**CYL BK DL60MM MATT BLACK**  
Available : • 60MM SN • 70MM SN  
• 60MM PB

### HALF CYLINDER



**CYL HC DL30+10MM MATT BLACK**  
Available : 30+10MM SN



**CYL HC DL40+10MM SN**



**CYL TC HC DL30+10MM MATT BLACK**  
Available : 30+10MM SN

## KOMPUTER KEY DOUBLE CYLINDER



**CYL DC KK DL60MM SN**  
Available : 70MM SN



**CYL DC KK DL60MM PB**  
Available : 70MM



**CYL DC KK DL60MM MATT BLACK**  
Available : 70MM

### THUMBTURN CYLINDER



**CYL TC KK DL60MM SN**  
Available : 70MM

**CYLINDER with MASTERKEY**



**MASTERKEY SYSTEM**

A Masterkey System is a key plan whereby selected key can open a number of pre-defined doors. Each door still has their own individual keys that cannot unlock other

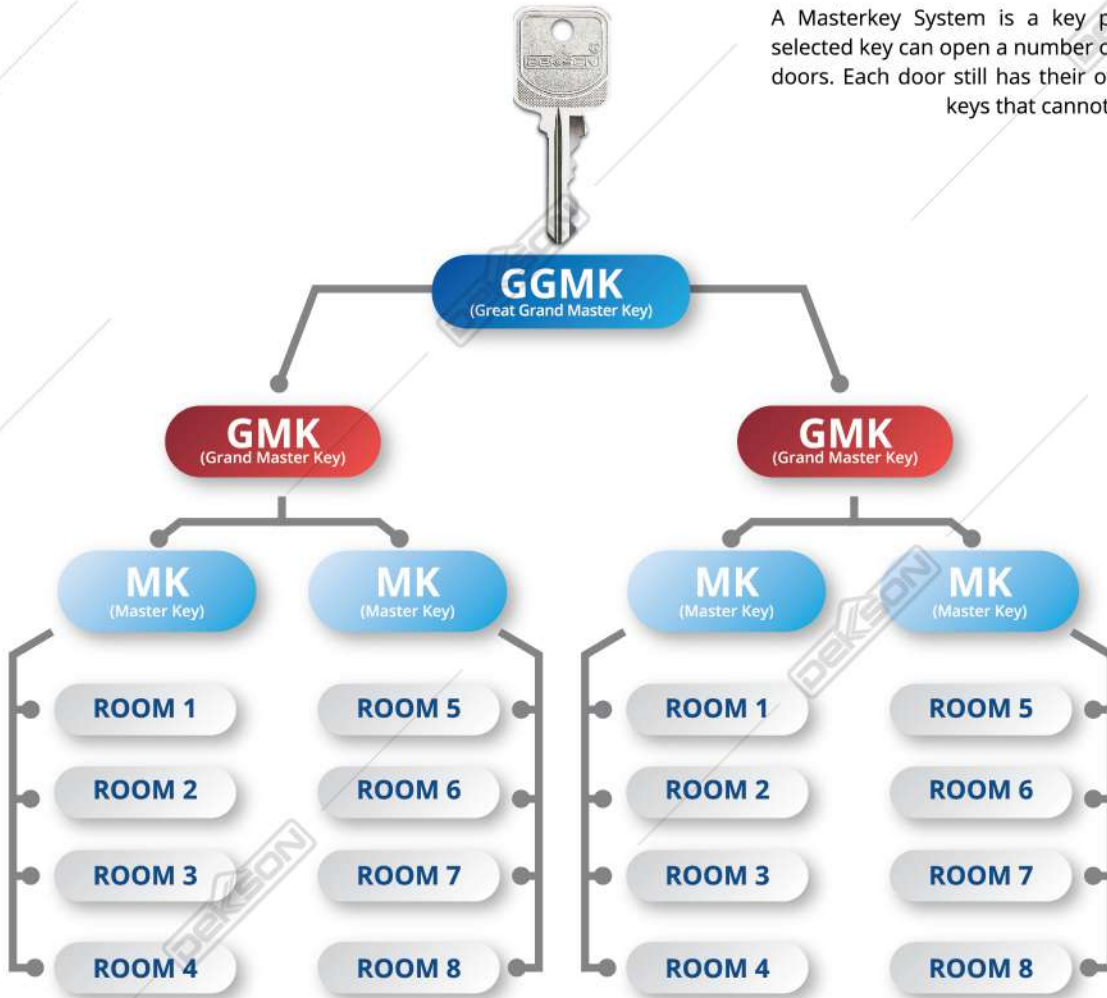

# ENTRANCE HANDLE

**5** YEAR  
MECHANICAL  
WARRANTY



**EHDL D8102 AC**  
Available : SN



**EHDL D8002 ODD SSS**



**EHDL D8003 ODD SSS**  
Available : AB\*



**EHDL D8004 ODD SSS**



**EHDL D7231 SN**



**EHDL D7297 SN**



**EHDL D8103 SN**  
Available : AC



# LOCKSET SERIES



**10 YEAR MECHANICAL WARRANTY** **HEAVY DUTY SYSTEM**  
**LS T8808Z ET SN**  
(For Entrance)

## TUBULAR HEAVY DUTY



**10 YEAR MECHANICAL WARRANTY** **HEAVY DUTY SYSTEM**  
**LS T8803Z ET SN**  
(For Entrance)

## TUBULAR LOCKSET



**KCBL T9587 ET SSS**  
(For Entrance)



**KCBL T9587 BK SSS**  
(For Toilet)

## CYLINDRICAL LOCKSET

**5 YEAR MECHANICAL WARRANTY**



**KCBL 8587 ET SSS**  
(For Entrance)



**KCBL 8587 BK SSS**  
(For Toilet)



**KCBL HD8000 ET SSS**  
(For Entrance)



**KCBL 8731 SSS + PSS**  
(For Entrance)



**KCBL 8366 CON DOOR ET SSS\***  
(For Connecting)

**DEAD LOCK**



**DL 901 DC SSS**



**DL 901 TC SSS**



**DL 901 TS SSS**  
Available : PB

**TUBULAR LEVER SET**



**LS T6200 ET SSS**  
(For Entrance)  
Available : PB  
• AB



**LS T6200 BK SSS**  
(For Toilet)



**LS T6300 ET SSS**  
(For Entrance)  
Available : • PB  
• AB



**LS T6300 BK SSS**  
(For Toilet)

**DELUXE LOCKSET SERIES\***

**CYLINDRICAL LOCKSET**



**KCBL DL3687 ET SSS**  
(For Entrance)



**KCBL DL3687 BK SSS**  
(For Toilet)

**DEAD LOCK**



**DL 968 TC SSS**



**DL 969 DC SSS**

**TUBULAR LEVER SET**



**LS T7200 ET SSS**  
(For Entrance)



**LS T7200 BK SSS**  
(For Toilet)



**LS T7300 ET SSS**  
(For Entrance)



**LS T7300 BK SSS**  
(For Toilet)

# DOOR CLOSER

**3** YEAR  
MECHANICAL  
WARRANTY



**DCL 105 NHO NA**  
Available : BA  
Capacity Max : 100 Kg

## OVERHEAD EXPOSE DOOR CLOSER

**CE**  
BS EN 1154

**UL**  
R39981



Include  
**BRACKET**



**DCL 300 NHO WH**  
Available : BA, NA, MATT BLACK  
Capacity Max : 40 Kg



**DCL 525 NHO NA**  
Available : BA  
Capacity Max : 40 - 100 Kg



**DCL 8916 NHO NA**  
Capacity Max : 20 - 150 Kg





**DCL 300 HO BA**  
Available : • NA  
• WH  
• MATT BLACK  
Capacity Max : 40 Kg



**DCL 529 HO NA\***  
Available : BA\*  
Capacity Max : 40 - 80 Kg



**DCL 1557 NHO**  
Capacity Max : 150 Kg



**BRACKET F/  
OPPOSITE POSITION  
DOOR CLOSER NA**  
Compatible For : • DCL 105  
• DCL 300

*\*to be ordered Separately*

## SLIDING ARM DOOR CLOSER

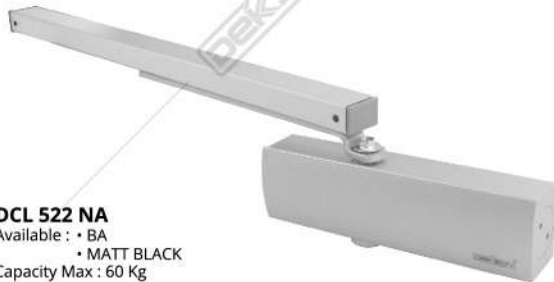

**DCL 522 NA**  
Available : • BA  
• MATT BLACK  
Capacity Max : 60 Kg



**DCL 525 SLD BA**  
Available : NA  
Capacity Max : 60 Kg

## CONCEALED DOOR CLOSER



**DCL C835 NA**  
Capacity : 60 - 90 Kg  
Available : MATT BLACK  
Max. Door Width : 900 mm



**DCL C883 NA**  
Capacity Max : 50 Kg  
Available : **DCL C882 MATT BLACK**  
Capacity Max : 70 Kg  
Max. Door Width : 800 mm

## DOOR CLOSER FOR SLIDING DOOR



**DCL SLD 1040 NA**  
Available : WH, BA, MATT BLACK  
Capacity Max : 40 Kg  
Max. Door Opening : 950 mm

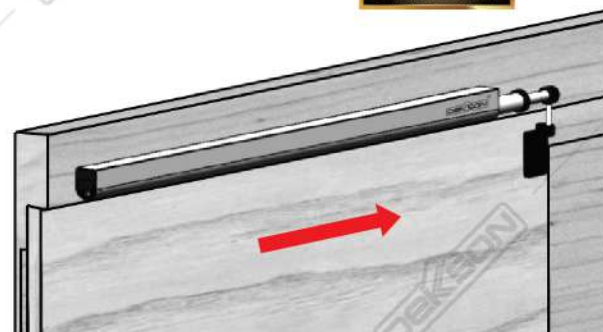

# ACCESSORIES FOR GLASS

SEE THE FULL COLLECTION OF DEKSON ACCESSORIES GLASS AT OUR ACCESSORIES GLASS BROCHURES

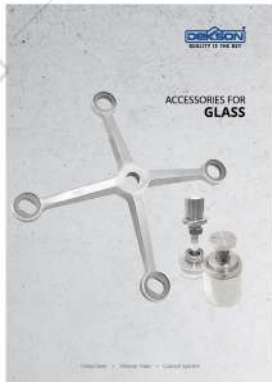

## FLOOR SPRING



**7 YEAR**  
MECHANICAL  
WARRANTY



**FH 84 MATT BLACK**  
Available : SSS

Type	Size	Door Weight (Max)	Door Width (Max)
FH 211 SSS	-	80 Kg	800 mm
FH 84 SSS	Normal	100 Kg	900 mm
FH 84 BD SSS		120 Kg	1100 mm
FH 84 BD SSS	4	120 Kg	1100 mm
FH 75 SSS	-	150 Kg	1200 mm
FH 80 SSS	-	300 Kg	1500 mm
FH 80 BD SSS	-	300 Kg	1500 mm

**3 YEAR**  
MECHANICAL  
WARRANTY



**FH 75 SSS**



**FH 80 SSS**



**FH 211 SSS**

## PATCH FITTING



**US 10 PSS**  
Available : MATT BLACK



**PT 10 MATT BLACK**  
Available : PSS



**PT 20 PSS**  
Available : MATT BLACK



**PT 24 MATT BLACK**  
Available : PSS



**PT 30 PSS**  
Available : MATT BLACK



**PT 40 MATT BLACK**  
Available : PSS



**PT 41 PSS RIGHT**  
Available : Left  
**PT 41 MATT BLACK**  
Available : Left or Right

## HYDRAULIC PATCH FITTING



**PTH 1080 PSS**  
Glass Thickness : 8 - 12 mm  
Door Width : 800 mm (max)  
Door Weight : 80 Kg (max)  
**FOR INDOOR USE**

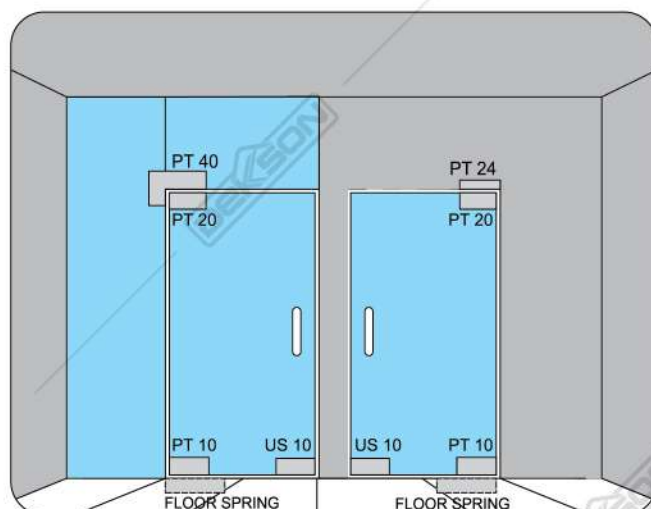
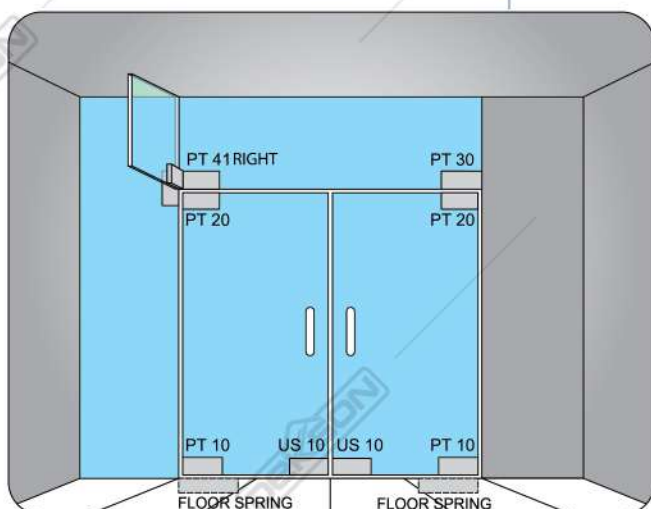



**160 SERIES**



SF 8211 160MM SSS



SF 8212 160MM SSS



SF 8213 160MM SSS



SF 8214 160MM SSS



SF 8241 160MM  
(ROUTE) SSS



SF 8245 160MM  
(BASE) SSS

Capacity (max) : 170 Kg / Lembar Kaca  
Glass Thickness : 10 - 15 mm

**220 SERIES**



SF 2201A SSS



SF 2201 SSS



SF 2202A (180) SSS



SF 2202 (90) SSS

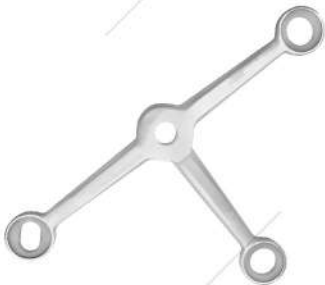

SF 2203 SSS



SF 2204 SSS



SF 2241 SSS  
(ROUTE)



SF 2245 SSS  
(BASE)

Capacity (max) : 220 Kg / Lembar Kaca  
Glass Thickness : 10 - 25 mm

**ILLUSTRATIONS**  
160 & 220 Series

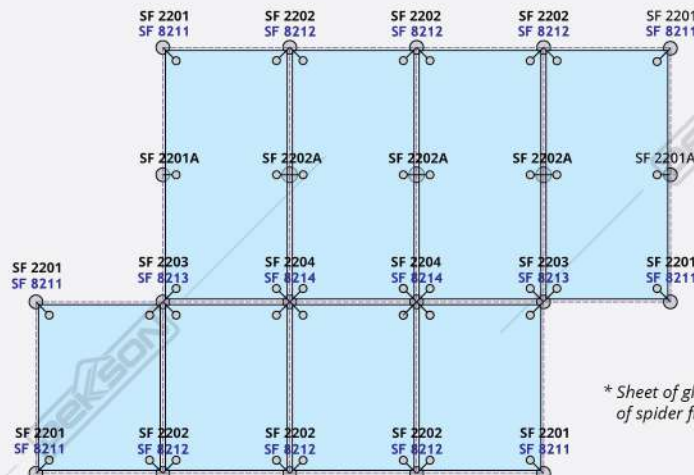

\* Sheet of glass supported by 4 pieces of spider fitting arms (4 Routels).



SF G2201A GLASS STRC SSS



SF G2201J GLASS STRC SSS



SF G2202A GLASS STRC SSS



SF G2202J GLASS STRC SSS



SF G2204 GLASS STRC SSS



SF G2241 GLASS ROUTEL STRC SSS

**ILLUSTRATIONS**

G220 Series

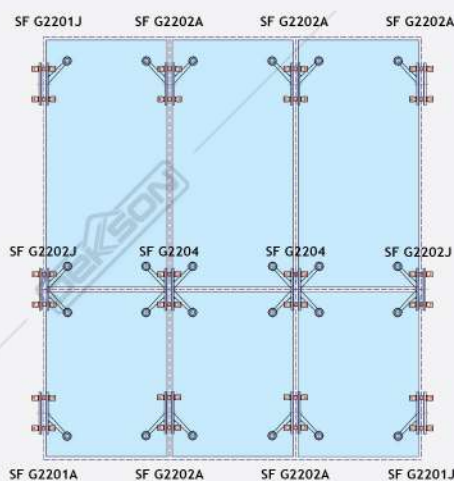

Capacity (max) : 220 Kg / Lembar Kaca  
Glass Thickness : 18 - 35 mm  
Material : Stainless Steel

\* Sheet of glass supported by 4 pieces of spider fitting arms ( 4 Routels).

**KEY FOR SPIDER FITTING**



ROUTEL SF 2241 PIN ATAS



BASE SF 2245 PIN ATAS



BASE SF 2245 PIN SAMPING



UNIVERSAL PIN ATAS



UNIVERSAL PIN SAMPING

# SLIDE & FOLD GLASS DOOR SLF 8610

Material : Stainless Steel SUS 304

## TOP ROLLER & TOP PIVOT HINGE



PV 861020 SSS



NH86102 SSS



RH 86102 SSS



RH 86103 SSS



RH 86101 SSS

## BOTTOM HINGE & LOCK BOLT HINGES & BOTTOM PIVOT HINGE



PV 861010 SSS



LH 861030 SSS



LH 86102 SSS



GH 861040 SSS



GH 8610401 SSS



LH86101 SSS

### BOLT KEEPER



BOLT KEEPER WITH DUST PROOF  
DP 89001WS SSS

### TRACK 5,8M NA

Available : • 2 M  
• 3,8 M



### U-CHANNEL

19.5x19.5x1.8x4.5M NA

Available : 19.5x19.5x1.8x2.25M



### DYNASET

DYNASET M8X30+BOLT M8X20



## ILLUSTRATIONS

Height Max : 2700 mm  
Width Max : 800 mm  
Glass Thickness : 10 mm & 12 mm  
Weight Max : 65 kg / panel  
Max. Leaf per set : 7 panel

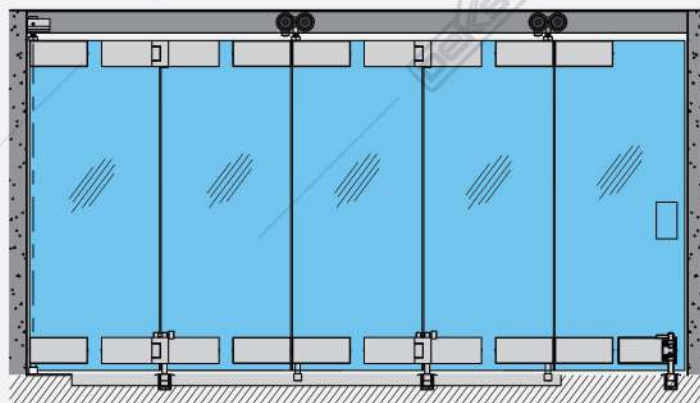



**DELUXE MAGTEC SD12 ACC SSS**



**ROLLER FOR TUBE**  
(2 pcs)



**STOPPER (LEFT/RIGHT)**  
(2 pcs)



**FLOOR GUIDE**  
(1 pc)



**TUBE CONNECTOR (GG)**  
(4 pcs)



**TUBE COVER**  
(2 pcs)



**TUBE CONNECTOR  
ACC SD 204 (GW)**



**SD12 TRACK 2 / 3M SSS**

*\*to be ordered separately*

**ILLUSTRATIONS**

Capacity Max : 65 Kg  
Glass Thickness : 10 - 12 mm

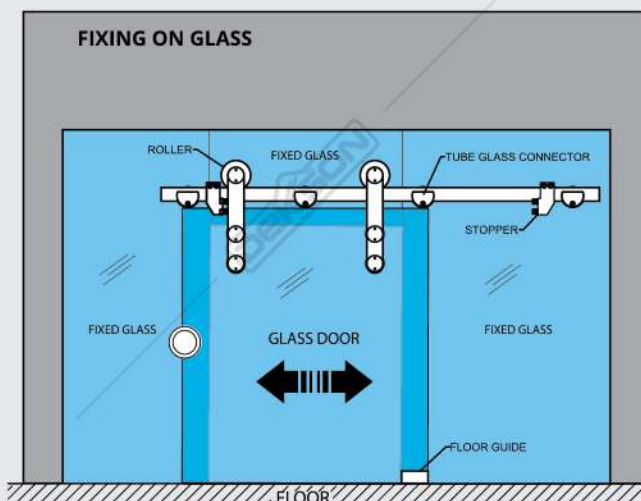
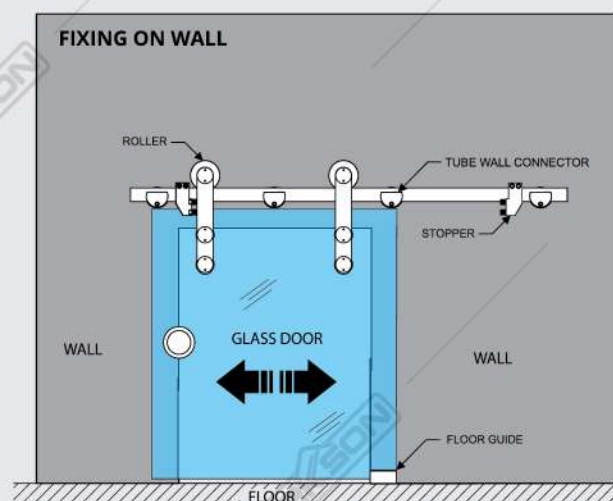

**HYDRAULIC SOFT CLOSER SLD HYD8970A SSS**



**CLAMP ROLLER**  
(2 pcs)



**FLOOR GUIDE 10 MM**  
(1 pcs)



**FLOOR GUIDE 12 MM**  
(1 pcs)



**SOFT CLOSER**  
(2 pcs)



**END CAP**  
(2 pcs)



**DOOR HANDLE**  
(1 pc)



**STOPPER**  
(2 pcs)



**GLASS CLAMP FOR TRACK HYD8970A PSS**

*\*to be ordered separately*



**TRACK SLD HYD8970A 2.2 M SAT + COVER**

Material : Aluminium

Available :

- TRACK SLD HYD8970A 3 M SAT + COVER
- TRACK SLD HYD8970A 4.2 M SAT + COVER

**ILLUSTRATIONS**

Capacity Max : 120 Kg  
Glass Thickness : 10 - 12 mm

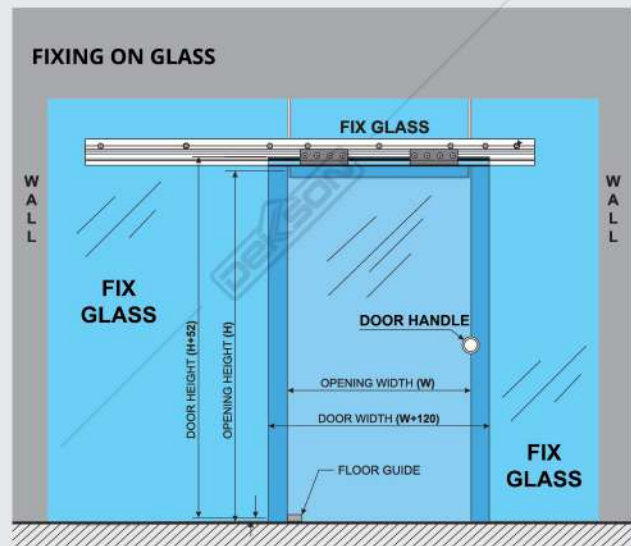
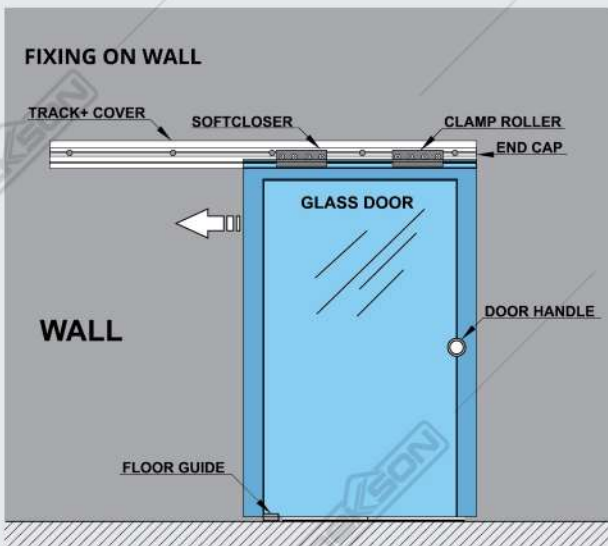

## SLIDING GLASS DOOR

### L4 SGD ACC L4 8207A SET



ROLLER + CLAMP  
(2 pcs)



STOPPER  
(2 pcs)



FLOOR GUIDE  
(1 pc)



FLOOR GUIDE INSET 10 MM  
(1 pc)



FLOOR GUIDE INSET 12 MM  
(1 pc)

Track : 2000 / 3000 mm  
Max. Capacity : 100 Kg  
Glass Thickness : 10 mm - 12 mm



SR D6 Track 2M / 3M

\* to be ordered separately.

### L6 SGD ACC 8922-57 COMPLETE SET



ROLLER + CLAMP  
(2 pcs)



STOPPER  
(2 pcs)



FLOOR GUIDE  
(1 pc)



FLOOR GUIDE INSET 10 MM  
(1 pc)



FLOOR GUIDE INSET 12 MM  
(1 pc)

Track : 2000 / 3000 mm  
Max. Capacity : 150 Kg  
Glass Thickness : 10 mm - 12 mm



SR D6 Track 2M / 3M

\* to be ordered separately.

### S6 SGD ACC 8922-63 COMPLETE SET



ROLLER + CLAMP  
(2 pcs)



STOPPER  
(2 pcs)



FLOOR GUIDE  
(1 pc)



FLOOR GUIDE INSET 10 MM  
(1 pc)



FLOOR GUIDE INSET 12 MM  
(1 pc)

Track : 2000 / 3000 mm  
Max. Capacity : 150 Kg  
Glass Thickness : 10 mm - 12 mm



SR D6 Track 2M / 3M

\* to be ordered separately.

### SR 89-2280-4RD SSS SET



ROLLER + CLAMP  
(2 pcs)



STOPPER  
(2 pcs)



FLOOR GUIDE  
(1 pc)



FLOOR GUIDE INSET 10 MM  
(1 pc)



FLOOR GUIDE INSET 12 MM  
(1 pc)

Track : 2000 / 3000 mm  
Max. Capacity : 200 Kg  
Glass Thickness : 10 mm - 12 mm



SR D6 Track 2M / 3M

\* to be ordered separately.



**SLIDING SHOWER**  
**SD S001 COMP + TRACK**



**TOP TRACK**  
SD S001-01A  
(2000 mm Long)



**DOOR KNOB**  
SD S001-07 (1 pc)



**ROLLER STOPPER**  
SD S001-03A (2 pcs)



**FLOOR GUIDE**  
SD S001-03 (1 pc)



**KNOB CLAMP ROLLER**  
SD S001-04 (2 pcs)



**MOUNTING BRACKET**  
SD S001-02A (2 pcs)



**ILLUSTRATIONS**

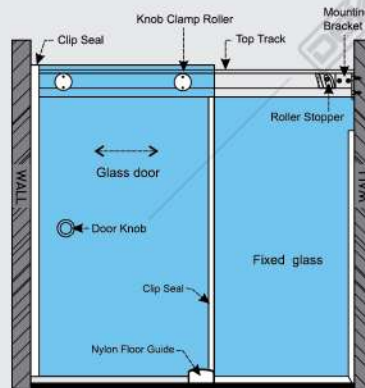

Capacity Max : 50 kg  
Glass Thickness : 8 - 10 mm  
Height Max : 2100 mm

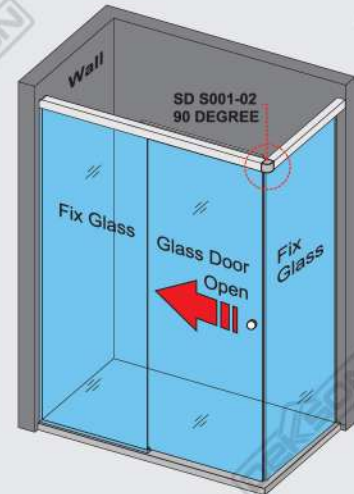

**SS02 ACC PSS**



**FLOOR GUIDE**  
(1 pc)



**ROLLER**  
(2 pcs)



**TRACK HOLDER FOR FIXED PANEL**  
(2 pcs)



**TRACK HOLDER FOR WALL**  
(2 pcs)



**ANTI LIFT**  
(2 pcs)



**STOPPER**  
(2 pcs)



**SS02 TRACK PSS**  
2000 mm Long



**SS02-13**  
**90 DEGREE PSS**

*\*to be ordered separately*

**ILLUSTRATIONS**

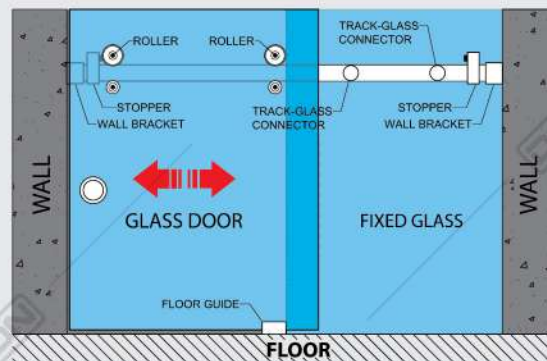

Capacity Max : 65 kg  
Glass Thickness : 8 - 10 mm  
Height Max : 2000 mm

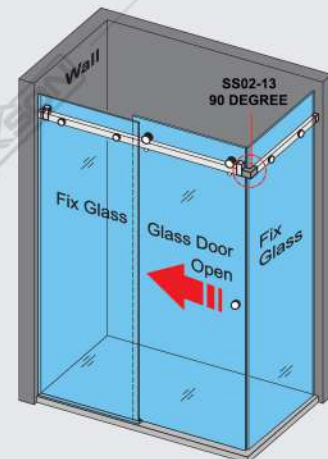

**SLIDING SHOWER GLASS DEKSON SOFT (OPEN+CLOSE) SS816**

**SLIDING SHOWER GLASS DEKSON SOFT (CLOSE+OPEN) SS816 TRACK CP**

Available color : ORB



**KITS FOR SOFT CLOSING**



**CLIP SEAL (1934MM)**



**THRESHOLD (640 MM)**



**UPPER TRACK + COVER (1230MM)**



**U-CHANNEL FOR FIX GLASS (2000 MM + 573 MM)**

**SLIDING SHOWER GLASS DEKSON SS816 (WW) CP**

Available color : ORB

**SLIDING SHOWER GLASS PART FOR SS816 (GW) CP**

Available color : ORB



**TOP ROLLER**



**HANDLE**



**180° GLASS TO SLIDING TRACK CONNECTOR**



**90° GLASS TO SLIDING TRACK CONNECTOR LEFT OR RIGHT**



**WALL MOUNT BRACKET LEFT OR RIGHT**



**THRESHOLD HOLDER TO WALL LEFT OR RIGHT**



**FLOOR GUIDE LEFT OR RIGHT**



**THRESHOLD HOLDER TO GLASS LEFT OR RIGHT**

**ILLUSTRATIONS**

Max Opening Width : 1241 mm  
Max Door Height : 2000 mm

**LEFT TO OPEN WALL TO GLASS**

Available : RIGHT

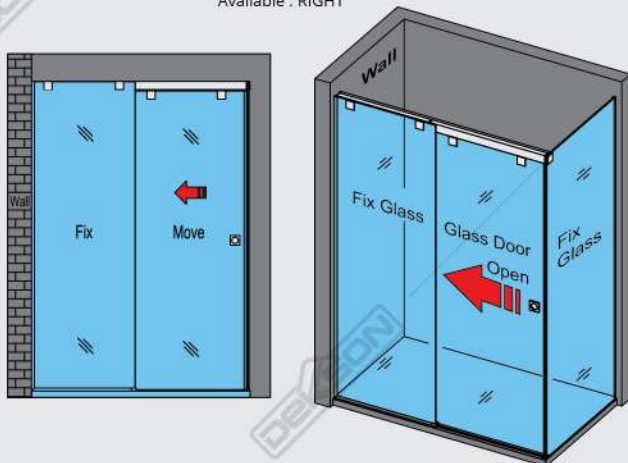

**RIGHT TO OPEN WALL TO WALL**

Available : LEFT

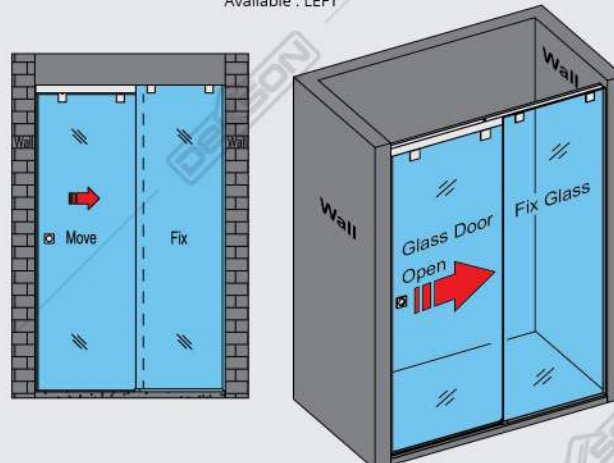

GLASS TO WALL



GLASS TO GLASS (180°)

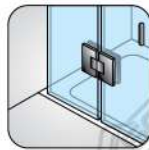

GLASS TO GLASS (90°)



GLASS TO GLASS (135°)

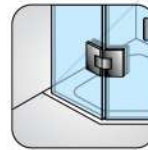

GLASS TO FLOOR



**SH 8331 CP**  
Glass Thickness : 8 - 10mm



**ASH 8701 CR (GW) CP**  
Glass Thickness : 8 - 10mm



**ASH 8703 CR (180) CP**



**SH 5301 (GW) PSS**  
Glass Thickness : 8 - 10mm  
Material : SUS 304



**SH 5303 (GG) PSS**



**SH 5305 (135) PSS**



**SH 7701 (GW) MATT BLACK**  
Available : CP  
Glass Thickness : 8 - 10mm



**SH 7702 (GW) CP**



**SH 7703 (180) MATT BLACK**  
Available : CP



**SH 7704 (90) CP**  
Available : MATT BLACK



**SH 7705 (135) MATT BLACK**  
Available : CP

**HEAVY DUTY**



**SH 9301 (GW) CP\***  
Glass Thickness : 8 - 12mm

**HEAVY DUTY**



**SH 9303 (180) CP**



**SH MF8201 SSS**  
Glass Thickness : 8 - 10mm



## DOOR KNOB



**DK AL 82801 CP**  
Available : MATT BLACK



**DK AL 82803 MATT BLACK**  
Available : • CP



**DK AL 82808 CP**  
Available : MATT BLACK



**DK 8716 58MM SSS**

## SLIDING GLASS LOCK



**SGL 7600 SUS 304 (GW) SSS**



**SGL 7601 SUS 304 (GG) SSS**



**SGL 8656 (GW) SSS**



**SGL 8656 (GG) SSS  
KEEPER**



**SGL 8656 (GG) SSS  
FIX KEEPER**

## GLASS DOOR LOCK



**GDL 8037D (GW) SSS**



**GDL 8037D (GG) SSS  
KEEPER**



**GDL 38225 PSS**



**GDL 38225A PSS**



**GDL 38231 PSS**



**GL 621 CP**



**GL 621-1 CP**



**GL 622 CP**



**GL 622-1 CP**



**GL 8600C CP**



**8601C CP KEEPER**

## INDICATOR LOCK

For Toilet



**IL 8620C CP**



**IL 8800 CP**



**IL 8801 CP**

## ADVERTISING FITTING



**ADV 19X60MM SSS**  
Available : • 19X50MM  
• 19X70MM



**ADV 25X50MM SSS**  
Available : • 25x50MM  
• 25x60MM  
• 25x70MM



**ADV 30X40MM SSS**  
Available : • 30x50MM  
• 30x70MM



**ADV 8626 19X30MM SSS**  
Available : • 19X40MM  
• 19X50MM  
• 19X60MM  
• 19X70MM



**ADV 8626 25X40MM SSS**  
Available : • 25x30MM  
• 25x50MM  
• 25x60MM  
• 25x70MM



**ADV 8626 30X50MM SSS**  
Available : • 30x30MM  
• 30x40MM  
• 30x60MM  
• 30x70MM



**ADV G01 32X10MM SSS\***  
Available : • 32x20MM\*  
• 32x30MM\*  
• 32x40MM\*  
• 32x50MM\*



**ADV G03 32X30MM SSS\***  
Available : • 32x10MM\*  
• 32x20MM\*  
• 32x40MM\*  
• 32x50MM\*  
• 40x80MM\*  
• 40x100MM\*



**ADV G001 ADJUST SSS**

## STAIRCASE RAILING

Material : Stainless Steel SUS 304



**SCR 36 830 SSS+WOOD**



**SCR 04 830 SSS**



**GC ST001 SSS**  
Available : MATT BLACK



**GLASS HOLDER BANISTER GH 14-01 OVAL SSS**  
Available : GH 14-01 STRAIGHT SSS



**SCH 0312 RW STRAIGHT SSS**  
Available : SCH 0312 RW OVAL SSS



**SCG 01 SINGLE SSS**



**SCG 01 DOUBLE SSS**



**SCH 01 OVAL SSS**



**SCH 01 STRAIGHT SSS**

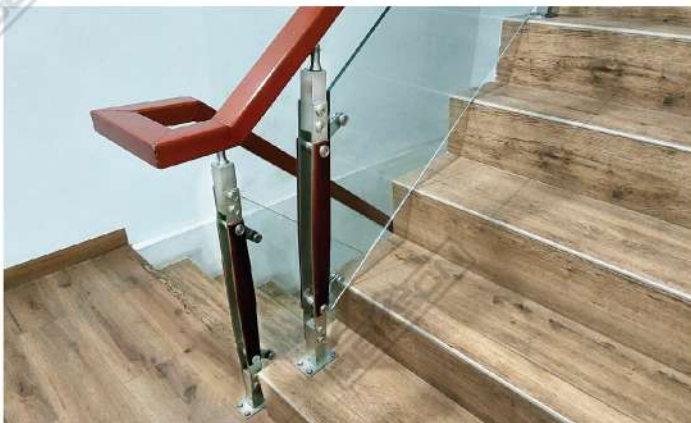

## GLASS HOLDER



GH 25-01 CP



GH 25-02 CP



GH 25-03 CP



GH 25-04 CP



GH 25-05 CP



GH 19-01 CP



GH 19-02 CP



GH 19-03 CP

## GLASS CLIP



GC 018 (GW) PSS



GC 018 (GG) PSS



GC 832 MATT BLACK  
Available : CP



GC 833 CP  
Available : MATT BLACK



GC U8541 MATT BLACK  
Available : PSS



GC Z-15G CP\*



GC BL002 SN



GC BL003 SN



GL DL009 SN



GC U800 AL CP



GC U820 PSS

## CLIP SEAL



CS 100 10X2.2M\*  
(90/180) WH



CS 110 10X2.2M\*  
(135/180) WH



CS 8910 10X2.2M\*  
OVAL



CS 8920 10X2.2M\*  
OVAL



CS BS 2.2M



CS SS 2.2M



CS OW 2.2M



CSB 001 10X2.2M\*  
Available: 12X2.2M\*



CSB 002 10X2.2M\*  
Available: • 12X2.2M\*  
• 12X3M\*



CS SS (10/12MM) 2.5M\*



CS BS (10/12MM) 2.5M\*

## CUBICAL TOILET



KT 304 (160MM) HD SSS



CT001 (8-10MM) SSS  
Available : PSS



**SILICONE**



**SILICONE DKS NEUTRAL**

Netto : 300 ml  
Available : CLEAR, BLACK, DARK BROWN, WHITE



**SILICONE DKS ACETIC SEALANT (EXTENDED)**

Netto : 300 ml  
Available : CLEAR, BLACK, BROWN, WHITE, LIGHT GREY

**SAUSAGE SILICONE**



**SILICONE DKS SAUSAGE NEUTRAL 8610**

Netto : 600 ml  
Available : WHITE, BLACK, DARK BROWN, BROWN, LIGHT GREY

**SILICONE GUN**



**SILICONE GUN TUBE DEKSON 8200**



**SILICONE GUN SAUSAGE DEKSON 8600**

**GLASS SUCTION**



**GSC 1S**



**GSC 3S**

# ACCESSORIES FOR ALUMINIUM

SEE THE FULL COLLECTION OF DEKSON ACCESSORIES ALUMINIUM AT OUR ACCESSORIES ALUMINIUM BROCHURES



## FRICTION STAY

### DELUXE HEAVY DUTY SIDE HUNG

Material : Stainless Steel SUS 304

HEAVY DUTY

STAINLESS STEEL  
SUS 304

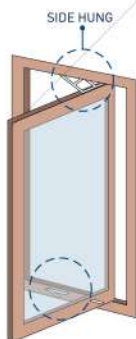

SIDE HUNG



DELUXE FS HD S250  
10", 12", 16"



DELUXE FS HD S250  
22"

### DELUXE HEAVY DUTY TOP HUNG

Material : Stainless Steel SUS 304

HEAVY DUTY

STAINLESS STEEL  
SUS 304

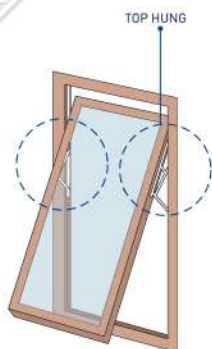

TOP HUNG



DELUXE FS HD T250  
10", 12", 16"



DELUXE FS HD T250  
18", 22" (R/L)



DELUXE FS HD T250  
28" (R/L)

**SIDE HUNG & TOP HUNG STANDARD DUTY**

Material : Stainless Steel SUS 304

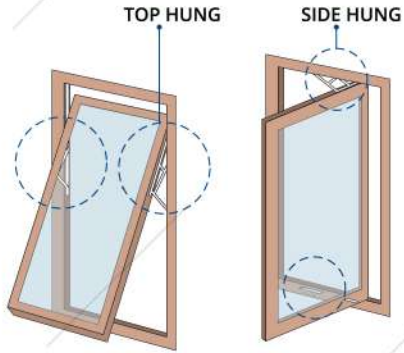

FS S/S 8"



FS S/S 10"



FS S/S 12"



FS S/S 14" 16"



FS S/S 20"



FS S/S 24"



FS S/S 28"



FS S/S 36"

**IRON FRICTION STAY**



FS IRON 8"



FS IRON 10"



FS IRON 14"



FS IRON 16"



FS IRON 20"



FS IRON 24"

**ARM STAY**

Material : Stainless Steel SUS 304



AR 6"



AR 12"\*



## CASEMENT HANDLE



**CHW 4 WH L/H & R/H**  
Available : • BK  
• NA  
• YB1C



**CH 400 NA**  
Available : • BK  
• WH  
• YB1C



**CH 420 NA L/H & R/H**  
Available : • BK  
• WH  
• YB1C



**CH 423 BK L/H & R/H**  
Available : • NA  
• WH  
• YB1C



**CH 425 WH L/H & R/H**  
Available : • BK • YB1C  
• NA • IVORY



**CH 428 BK L/H & R/H**  
Available : • WH  
• NA  
• YB1C



**CH 429 N-LOCK NA L/H & R/H**  
Available : • BK  
• WH  
• YB1C



**CH 429 LOCK YB1C L/H & R/H**  
Available : • NA  
• WH  
• BK

## CRESCENT LOCK



**CL 330 BK**  
Available : • WH • YB1C  
• NA



**CL 393 N-LOCK BK L/H & R/H**  
Available : WH



**CL 393 LOCK BK L/H & R/H**  
Available : WH

## ESPAGNOLETTE



**BLACK**



**WHITE**



**YB1C**

**EPL H AL 874A**

Available :  
L/H - Left Position  
R/H - Right Position

**EPL AL 874A**

Available : • 600 MM  
• 1000 MM  
• 1500 MM

## ROLLER



**RSD 001 HD\***  
Capacity (Max) : 75 kg / pairs



**RSD 100 HD**  
Capacity (Max) : 100 kg / pairs



**RSD BESAR**  
Capacity (Max) : 50 kg / pairs



**RSD BESAR HD**  
Capacity (Max) : 75 kg / pairs



**RSW KECIL**  
Capacity (Max) : 25 kg / pairs



**SCR 001 BIG CP**  
Capacity (Max) : 13 kg / pairs



**SCR 001 SMALL CP**  
Capacity (Max) : 7 kg / pairs

## ROLLER CASTER



**RC 250 50MM BRAKE**  
Capacity (Max) : 50 kg / pair



**RC 250 50MM NO BRAKE**  
Capacity (Max) : 50 kg / pair



**RC 260 75 MM BRAKE**  
Capacity (Max) : 60 kg / pair



**RC 260 75 MM NO BRAKE**  
Capacity (Max) : 60 kg / pair

## LOCK



**KC KAWAKAMI**

**LOCKSET**



**KC 8123**



**KC T8123**



**KC 88130 (PD)**



**KC 8128 (PJ)**  
Available : • KC 8128 (PD)



**KC T8128**



**KC 87130**



**KC 8423**



**KC T8423**



**CYLINDER FOR KC 8128**

**EKSPANDA**

**SLIDING HANDLE**



**KC 8203 BK**  
Available : • BA  
• WHITE



**KC 909 BA**  
Available : WHITE



**HDL AL 101 (RA6) WH**  
Available : BK



**HDL AL 102 (RA6) WH**  
Available : BK



**SLH XL80 BK\***  
Available : • WH\*  
• NA\*  
• DB\*

**SLIDING LOCK**



**J8A BK L/R**  
Available : WH



**J8B BK**  
Available : WH



**J8C WITH LOCK WH**  
Available : BK



**J8C WH**  
Available : BK



**J8D WH**  
Available : BK



**KS RA6 NA**  
Available : • WH  
• BK  
• YB1C



**KS Z08A BK**  
Available : • BA  
• NA  
• WH



**KS J5K ONE SIDE KEY BK**  
Available : • NA  
• WH  
• YB1C

## FLUSH BOLT

Material : ZINC + STEEL



**FB 508 NA**

Available : • BK  
• WH  
• YB1C



**FB 808 BA**

## PROTECTION TAPE



**PTT ECO 80 MKX1.22MX100M BLACK / WHITE**

Available : ECO 65 MKX1.22MX100M BLACK / WHITE



**PTT 50 MKX1,22MX100M BLUE**

## MOHAIR



**MOHAIR SIL 0.48X0.9X250M BLACK\***



**MOHAIR SIL 0.69X0.7X200M BLACK\***

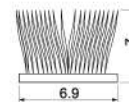

**SMALL MOHAIR SIL 0.69X0.5X200M GREY**

Available : BLACK

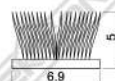

**BIG MOHAIR SIL 1.1X0.7X175M BROWN**

Available : BLACK, GREY

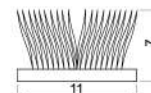



# ACCESSORIES FOR WOOD



**DOOR STOPPER**



**DS 001 SSS**



**DS 002 SSS**



**DS 003 SSS**



**DS 006 SSS**



**DS 008 SSS**



**DS 009 SSS**



**DS 886 SN**  
Available : • GP  
• MATT BLACK\*



**DS 887 SN**  
Available : GP



**DS 019 BK**



**MDS 001 BROWN**  
Available : IVORY



**MDS 007 SN**  
Available : PVD



**MDS 047BR SN**



**MDS 189 MATT BLACK + CP**



**MDS 220 CP**



**MDS 825 SN**  
Available : PB



**MDS 889 SN**



**MDS 890 MATT BLACK**  
Available : SN

## FLUSH BOLT



**FB 040 8" MATT BLACK**  
Available : SSS



**FB 040 12" SSS**  
Available : • 12" MATT BLACK  
• 18" SSS



**FB 040 24" SSS**  
Available : 40" SSS



**FB 050 8" SSS**  
Available : 12" SSS



**FB 050 18" SSS**



**FB 050 24" SSS**



**FB 608 BR 6" SN**  
Available : • 6" PB  
• 6" AB



**FB 608 BR 12" AB**  
Available : • 12" SN • 18" SN  
• 12" PB • 18" PB  
• 18" AB



**FB 608 BR 24" PB**  
Available : • 24" SN • 36" SN  
• 24" AB • 36" PB  
• 36" PB



**FBP 2,5" SSS**  
Available : 6" SSS



**FBP 8" SSS**  
Available : 12" SSS



**FB 707 AT SSS**  
L/H or R/H

## DOOR BOLT



**DB AL805 MATT BLACK**  
Available : SILVER



**DB SQ 3" SSS**  
Available : 2" SSS



**DB D02 2" SSS**  
Available : 3" SSS



**DB D03 18" SSS**  
Available : • 24" SSS  
• 40" SSS

## LOCK



**KLV 021LI SSS**



**KSH 8901 SSS**



**KSH 8902 SSS**



**LFS 001P 60MM SSS**

**DOOR SEAL**



**ZS A802 NA**  
Available : YB1C



**"D" PROFILE DSD 9X6MM (@ 25 M) WH\***  
Available : • @ 5.4 M WH\*  
• @ 5.5 M WH\*  
• @ 25 M BROWN\*



**AUTOMATIC D051 1000MM NA**  
Available : 900MM NA\*

**OTHERS**

**SPRING KNIP**



**DC 005 SSS**



**DC 010 SN**  
Available : PB



**DG 020 SN**  
Available : PB



**DG 81005 SN**



**SK 018 BR SN**  
Available : • PB  
• AB  
• MATT BLACK



**SK 028 SQ SN**



**DV 200 CP**  
Available : MATT BLACK



**DP 003 SSS**  
Available : PVD



**EC 003 SB**



**RC 221 CP**



**SK 818 SSS**



**SK 828 SQ SSS**

**WINDOW HOLDER**

**CAM WINDOW HANDLE**



**WH 010 SSS**  
Available : AB



**WS 001 8" SSS**  
Available : 10" SSS



**WS 011Z 8" SN**



**CWH 103Z MATT BLACK**  
Available : • 103Z SN  
• 103 SSS



**CWH 104 SQ PB**  
Available : SN



**WS BR SQ01 8" SN**  
Available : • 8" PB • 8" MATT BLACK  
• 10" SN • 10" MATT BLACK



**WS SQ 002 8" CP**



**WS HX 002 8" CP**



**CWH 105 SQ SN**  
Available : • PB  
• MATT BLACK



**CWH ZC 104 SQ MATT BLACK**  
Available : SN



**AWH 001 BR PB**  
Available : SN



**AWH SQ 001 SSS**



**AWH SQ 002 8" SSS**



**CWH ZC 105 SQ SN**  
Available : MATT BLACK



**CWH 127Z SN**  
Available : MATT BLACK



## WINDOW BOLT



**WB 001 SSS**  
**WB 001 50MM SSS**



**WB with KEY SSS**

## ESPAÑOLETTE



**CLW COTS 510 Z SN**  
Available : GP



**WDH 5003 SSS**



**WDH 530 SSS**  
Available : PVD



**WDH 539 SSS**



**EPL DEKSON**  
Available :  
• 640MM SSS  
• 1000MM SSS  
• 1600MM SSS

**EPL COTS**  
Available :  
• 640MM SN  
• 1000MM SN  
• 1600MM SN  
• 2000MM SN

## PADLOCK



**PL 811 46MM SP**



**PL 11 50MM SP SSS**  
Available : 3 MK



**PL 11 60MM SP SSS**  
Available : 3 MK



**PL SQ 11 50MM SSS**  
Available : 3 MK



**PL SQ 11 60MM SSS**  
Available : 3 MK



**PL 13-85MM SN**



**PL 100 20MM CP**  
Available : • 40MM CP  
• 50MM CP  
• 60MM CP



**PL 200 40MM S SN**  
Available : • 50MM S SN  
• 60MM S SN



**PL 200 50MM L SN**  
Available : • 40MM L SN  
• 60MM L SN



**PL LUGGAGE TSA 3533 SQ SILVER**  
Available : • BLACK  
• BLUE

# ACCESSORIES FOR SLIDING DOOR



**SLIDING RAIL FOR ALUMINIUM, WOOD & STEEL DOOR**

**10 YEARS**  
MECHANICAL WARRANTY



ROLLER (2 pcs)



BRACKET (4 pcs)



STOPPER (2 pcs)



FLOOR GUIDE (1 pc)



**SR 8701 D3 1.8M NA**

Type	Track	Capacity (Max.)
D3	1800 mm	45 kg



TRACK 1.8M



U-CHANNEL 1M (1 pc)



**SR 8901 D4 2M NA**

Type	Track	Capacity (Max.)
D4	2000 mm	100 kg



ROLLER (2 pcs)



BRACKET (4 pcs)



STOPPER (2 pcs)



FLOOR GUIDE (1 pc)



U-CHANNEL 1M (1 pc)



TRACK 2M



ROLLER (2 pcs) - For Single  
ROLLER (4 pcs) - For Double



BRACKET (7 PCS) - For Single  
BRACKET (8 PCS) - For Double



STOPPER (2 pcs)



FLOOR GUIDE (1 pcs) - For Single  
FLOOR GUIDE (2 pcs) - For Double



**SR 6901 D6 3M NA**  
Available : D6 DOUBLE 3M NA

Type	Track	Capacity (Max.)
D6	3000 mm	150 kg



TRACK 3M



U-CHANNEL 1M (1 pc) - For Single  
U-CHANNEL 1M (2 pcs) - For Double



# SLIDING DOOR DOUBLE ACTION SOFT CLOSE & OPEN



**DBL ACT SOFT (Close + Open)  
SCO 8020 2M**  
Capacity Max. : 80 kg



Softly close and open door, avoid hard impact for long lasting sliding door



**DBL ACT SOFT (Close + Open)  
SCO 6020 2M**  
Capacity Max. : 60 kg



**ILLUSTRATIONS**

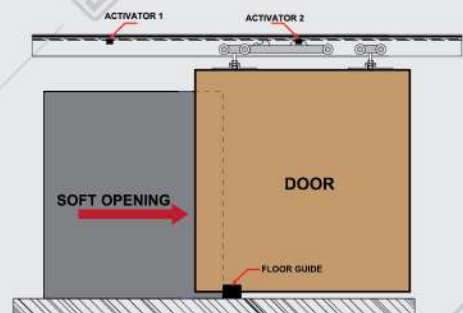
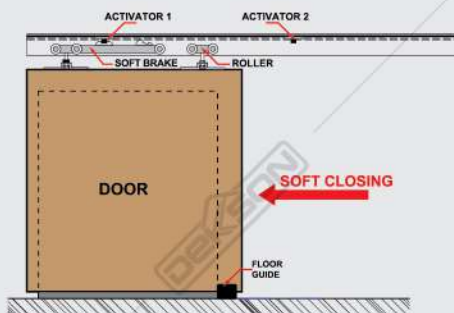

# ACCESSORIES FOR SLIDE & FOLD DOOR

SEE THE FULL COLLECTION OF DEKSON ACCESSORIES SLIDE & FOLD AT OUR ACCESSORIES SLIDE & FOLD BROCHURES

**10 YEARS**  
MECHANICAL WARRANTY

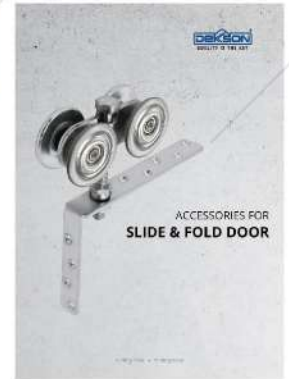

## INTERIOR & EXTERIOR SLIDE & FOLD ACCESSORIES

### SPEKIFIKASI

- Max. Door Weight : 80 Kg / door leaf
- Max. Door Height : 2400 mm
- Door Width : 40 - 50 mm

Available Max. Door Weight : 60 Kg / door leaf



WH 7186 (57MM)  
GALV



WH 7174-RD 4 (57MM)  
GALV



WH 7185 (57MM)  
GALV



WH 7184-RD 4 (57MM)  
GALV



WH 9105 (57MM)  
GALV



WH 8144-RD 4 (57MM)  
GALV



WH 8195-L (57MM)  
GALV



WH 8196-L (57MM)  
GALV



WH 9106 (57MM)  
GALV



**WH 7286 (38/57MM) GALV**



**WH 7285 (38/57MM) GALV**



**WH 8205 (57MM) GALV**



**WH 8206 (57MM) GALV**



**HN 8306 (57MM) GALV**



**BR 9100 (57MM) GALV**



**BR 9101 (57MM) GALV**



**BR 9185 (57MM) GALV**



**BB 8104-UK 75CM (38/57MM) GALV**



**BB 9204 (38/57MM) GALV**



**BB 8204 (38/57MM) GALV**



**TR 9123 - 2,3M (57MM) GALV**  
Available : 2,9M (57MM) GALV



**TR 9244 - 2,4M (38/57MM) GALV**  
Available : 3M (38/57MM) GALV



**TR 9190 (57MM) GALV**



**BR 9102 (57MM) GALV**



**BF 3/8X2,5" (38/57MM) GALV**  
Available : • 3/8X3" (38/57MM) GALV  
• 3/8X4" (38/57MM) GALV

**ILLUSTRATIONS**

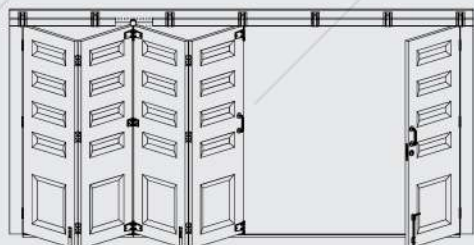

▲ Pintu Dorong Lipat Eksterior Roda "Standard" & "L"

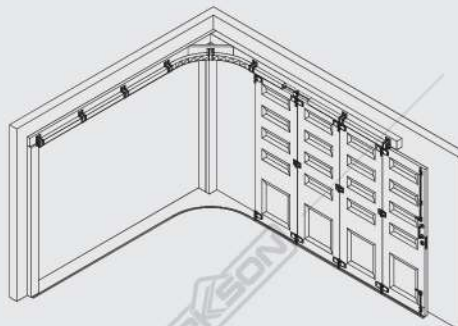

▲ Pintu Dorong Menikung Eksterior Roda "Standard"

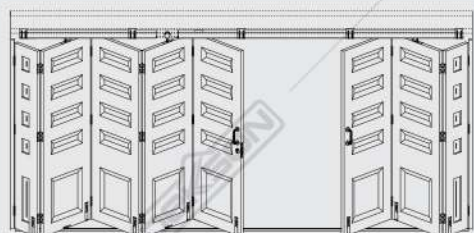

▲ Pintu Dorong Lipat Tengah Interior

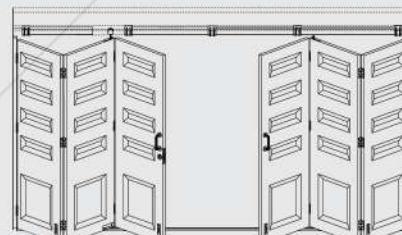

▲ Pintu Dorong Lipat Pinggir Interior



# ACCESSORIES FOR FURNITURE

SEE THE FULL COLLECTION OF DEKSON ACCESSORIES FURNITURE AT OUR ACCESSORIES FURNITURE BROCHURES



## FURNITURE HINGE



**ESS 50X40X1,5MM 2NR SSS**  
Capacity (Max) : 15 kg/pair

**ESS 63x40x1,5MM 4NR SSS**  
Capacity (Max) : 20 kg/pair



**ESS EL 1,8M SSS**

**ES SL 5" SN**  
Available : • 5" CP • 5" SSS (SUS 304)  
• 9" CP • 9" SSS (SUS 304)  
• 9" SN

### GALVANIZED STEEL

Capacity (Max) : 7 kg/pair



**HYD ES SD 01 FULL OVERLAY CP**



**HYD ES SD 01 HALF OVERLAY CP**



**HYD ES SD 01 INSET CP**

### STAINLESS STEEL SUS 304



**HYD 304 ES SD101 FULL OVERLAY PSS**



**HYD 304 ES SD101 HALF OVERLAY PSS**



**HYD 304 ES SD101 INSET PSS**



**HYD ES SD GLASS D26 FULL OVERLAY CP**



**HYD ES SD GLASS D26 HALF OVERLAY CP**



**HYD ES SD GLASS D26 INSET CP**



**HYD ES SD GLASS D35 FULL OVERLAY CP**



**HYD ES SD GLASS D35 HALF OVERLAY CP**



**HYD ES SD GLASS D35 INSET CP**

## FURNITURE SLIDING ACCESSORIES

### FURNITURE BALL BEARING



**FBB 250MM SLOWMOTION GALV**

- Available :
- 300MM SLOWMOTION GALV
  - 350MM SLOWMOTION GALV
  - 400MM SLOWMOTION GALV
  - 450MM SLOWMOTION GALV
  - 500MM SLOWMOTION GALV
  - 550MM SLOWMOTION GALV



**FBB 250MM SLOWMOTION BLACK**

- Available :
- 300MM SLOWMOTION BLACK
  - 350MM SLOWMOTION BLACK
  - 400MM SLOWMOTION BLACK
  - 450MM SLOWMOTION BLACK
  - 500MM SLOWMOTION BLACK
  - 550MM SLOWMOTION BLACK



**FBB 35300MM SLOW MOTION BLACK**

- Available :
- 35350MM SLOWMOTION BLACK
  - 35400MM SLOWMOTION BLACK
  - 35450MM SLOWMOTION BLACK
  - 35500MM SLOWMOTION BLACK
  - 35550MM SLOWMOTION BLACK



**FBB 250MM STANDARD BLACK**

- Available :
- 300MM STANDARD BLACK
  - 350MM STANDARD BLACK
  - 400MM STANDARD BLACK
  - 450MM STANDARD BLACK
  - 500MM STANDARD BLACK
  - 550MM STANDARD BLACK



**FBB 35300MM STANDARD BLACK**

- Available :
- 35400MM STANDARD BLACK
  - 35350MM STANDARD BLACK
  - 35450MM STANDARD BLACK
  - 35500MM STANDARD BLACK



**FBB 300MM PUSH OPEN&CLOSE BLACK**

- Available :
- 350MM PUSH OPEN&CLOSE BLACK
  - 400MM PUSH OPEN&CLOSE BLACK
  - 450MM PUSH OPEN&CLOSE BLACK
  - 500MM PUSH OPEN&CLOSE BLACK
  - 550MM PUSH OPEN&CLOSE BLACK

### FURNITURE CONCEAL SLIDE (SLOWMOTION)



**FCS 300MM DOUBLE EXT GALV\***

- Available :
- 350MM DOUBLE EXT GALV
  - 400MM DOUBLE EXT GALV
  - 450MM DOUBLE EXT GALV
  - 500MM DOUBLE EXT GALV
  - 550MM DOUBLE EXT GALV



**FCS 300MM DOUBLE EXT SLOW MOTION GALV**

- Available :
- 350MM DOUBLE EXT SLOWMOTION GALV
  - 400MM DOUBLE EXT SLOWMOTION GALV
  - 450MM DOUBLE EXT SLOWMOTION GALV
  - 500MM DOUBLE EXT SLOWMOTION GALV
  - 550MM DOUBLE EXT SLOWMOTION GALV



**FCS 300MM DOUBLE EXT PUSH OPEN&CLOSE GALV**

- Available :
- 350MM DOUBLE EXT PUSH OPEN&CLOSE GALV
  - 400MM DOUBLE EXT PUSH OPEN&CLOSE GALV
  - 450MM DOUBLE EXT PUSH OPEN&CLOSE GALV
  - 500MM DOUBLE EXT PUSH OPEN&CLOSE GALV
  - 550MM DOUBLE EXT PUSH OPEN&CLOSE GALV

### FURNITURE SOFT ROLLER



**FSR 250MM WH**

- Available :
- 300MM WH
  - 350MM WH
  - 400MM WH
  - 450MM WH
  - 500MM WH
  - 550MM WH
  - 600MM WH

## FURNITURE HANDLE

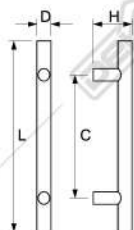

### FH D108 SSS

Note :  
 - L : Length  
 - C : C to C (As)  
 - D : Diameter  
 - H : High  
 - Material : SUS 304

TYPE	SIZE (MM)			
	L	C	D	H
FH D108 10X100MM SSS	100	64	Ø10	32
FH D108 10X120MM SSS	120	64	Ø10	32
FH D108 10X150MM SSS	150	96	Ø10	32
FH D108 10X200MM SSS	200	128	Ø10	32
FH D108 10X250MM SSS	250	160	Ø10	32
FH D108 12X120MM SSS	120	64	Ø12	35
FH D108 12X150MM SSS	150	64	Ø12	35
FH D108 12X200MM SSS	200	128	Ø12	35
FH D108 12X250MM SSS	250	160	Ø12	35
FH D108 12X300MM SSS	300	192	Ø12	35
FH D108 12X350MM SSS	350	255	Ø12	35
FH D108 12X400MM SSS	400	288	Ø12	35
FH D108 12X450MM SSS	450	320	Ø12	35
FH D108 12X500MM SSS	500	360	Ø12	35

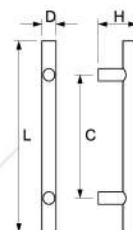

### FH D208 SSS

Note :  
 - L : Length  
 - C : C to C (As)  
 - D : Diameter  
 - H : High  
 - Material : SUS 304

TYPE	SIZE (MM)			
	L	C	D	H
FH D208 12X100x64MM	100	64	Ø10	32
FH D208 12X150x96MM	150	96	Ø10	32
FH D208 12X200x128MM	200	128	Ø10	32

## FURNITURE LOCK



DL 138



PL 105 CP



CL 103 30MM CP  
 Available : • CL 103 20MM CP  
 • CL 103 25MM CP



KG 001 CP

## FURNITURE ACCESSORIES



SPRING SUPPORT SPS 8152 - 100N SILVER  
 (WITH SOFT CLOSER)



FR 388\*



TL 30X10MM M8\*



# ACCESSORIES FOR STEEL DOOR

SEE THE FULL COLLECTION OF DEKSSON ACCESSORIES STEEL DOOR AT OUR ACCESSORIES STEEL DOOR BROCHURES



**10 YEARS**  
MECHANICAL WARRANTY

## PANIC DEVICE

### PANIC EXIT DEVICES WITH BAR AND SINGLE POINT

**ISEO**  
Made in Italy



HANDLE & KEY  
9401107T MET GREY

HANDLE & KEY  
9401105T BLACK

- ISEO BASE PANIC EXIT 941400504 (BLACK)+BAR 945928 (RED)
- ISEO SINGLE POINT IDEA 941113774A (METALLIC GREY)
- ISEO PUSH PANIC 94211758T (BLACK)

### PANIC EXIT DEVICES WITH BAR AND 2 POINT BOLT

**ISEO**  
Made in Italy



- ISEO 2 POINT 9432000504 (BLACK) + BAR 945928 (RED) + ROD 94300205
- ISEO 2 POINT IDEA 9432083774 (METALLIC GREY)
- ISEO PUSH 2 POINT BOLT 9452117584 + 94300205 (ROD 2400MM)
- ISEO PUSH 2 POINT BOLT 9452117584 + 94300305 (ROD 3400MM)

**DEKSON**  
QUALITY IS THE KEY



HANDLE PD0701 BLACK

SINGLE POINT RIM TYPE PD0701 (BLACK/RED)

**DEKSON**  
QUALITY IS THE KEY



DEKSON 2 POINT LATCH RIM PD0702 (BLACK/RED)

**ISEO EXIT DEVICE WITH BAR PALMO AND 2 POINT BOLT**



ISEO PALMO 2 POINT BOLT 949000050379  
+ COUNTER L + RELATCH + ROD

**PANIC EXIT DEVICE WITH BAR MORTISE**



ISEO PALMO 949000050379 + MTS

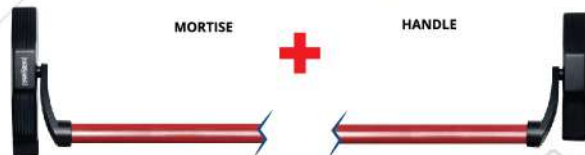

PANIC EXIT DEVICE PD8700 + MTS + HDL  
BLACK/RED

**HINGE**

**STAINLESS STEEL HINGE SUS 304**



ESS DL  
3X2,5X2MM 2BB SSS



ESS DL  
4X3X2MM 2BB SSS



ESS DL  
4X3X3 MM 2BB NRP SSS



ESS DL  
4X4X3MM 2BB SSS



ESS DL  
4,5X4X3MM 2BB SSS



ESS DL  
5X3X3MM 4BB NRP SSS

**GALVANIZED HINGE**



ES IR  
34X90 - 39X90 GALV



ES IR  
64X90 - 39X90 GALV

**DOOR CLOSER**



CE  
BS EN 1154

DEKKSON DCL 525  
NHO NA Fire-rated (40-100 kg)



DEKKSON DCL 105  
NHO NA (100 kg)



DEKKSON DCL 1557  
NHO NA (150 kg)



UL  
R39981

DEKKSON DCL 8916  
NHO NA (150 kg)

**FLUSH BOLT**



FB SQ 501 270MM



FB SQ 501 370MM



FB 707 AT SSS R/L

**LIFETIME**  
Warranty  
for Mechanical Only

**HANDLE**

**HANDLE + KNOB SSS**



LHSR CURVE Ø22MM  
(ISEO)



LHSR 016 Ø22MM + KNOB  
(DEKKSON)



**HANDLE STAINLESS STEEL**



• LHSR CURVE Ø22MM  
(ISEO)



• LHSR CURVE Ø22MM  
(ISEO)



KNOB ONLY  
(ISEO)



• LHSR 016 Ø22MM  
(DEKKSON)



• LHSR 016 Ø22MM  
(DEKKSON)



ESCN D01 SSS  
(DEKKSON)

**CYLINDER**

**DOUBLE CYLINDER**

**HALF CYLINDER**



CYL ISEO F5 DC  
• 820935359 (70MM) SN



CYL ISEO F6 DC  
• 810935359 (70MM) SN  
• 810935359 (80MM) SN



CYL ISEO R6 DC  
• 880935359 (70MM) SN  
• 880940409 (80MM) SN



CYL DEKSON DC  
• DC 70MM  
• DC 80MM



CYL DEKSON HC  
• 40MM  
• 50MM



## MORTISE LOCK



MORTISE LOCK PANIC FUNCTION  
MTS IL 8672 PANIC SSS



MORTISE LOCK NON PANIC FUNCTION  
MTS IL 8672 SSS



MORTISE DEADBOLT  
MTS DB 40MM SSS

## OTHERS

### PULL PLATE



HDL DEKSON PP 009 SSS

### LATCH BOLT



DEKSON CLW 510Z SN



DEKSON LFS 001P 60MM SSS

### DOOR SELECTOR



DSR 300 SSS

### WINDOW BOLT



WB 001 50MM SSS



WINDOW BOLT SS WITH KEY

### DOOR SEAL



"D" PROFILE DSD 9X6MM (@ 25 M) WH\*

- Available :
- @ 5.4 M WH\*
  - @ 5.5 M WH\*
  - @ 25 M BROWN\*

### DOOR STOPPER



DS 002 SSS



DS 006 SSS



DS 886 SN



**HUBUNGI :**



**QHOMEMART**

**JL. RAYA JANTI NO.96 YOGYAKARTA  
(0274) 493 22 88 , 08112863773 (CHAT ONLY)**

**f qhomemart    t qhomemart    @ qhomemart    v qhomemart**

**WWW.QHOMEMART.COM**