

evomab®

smart home system



product
catalogue

Edisi Januari 2021

Tersedia di :  **QHOME MART**

08112863773 (CHAT ONLY)

Digital Lock

10 YEAR WARRANTY
FOR MORTISE MECHANICAL

2 YEAR WARRANTY
FOR FINGERPRINT READER



EDLF-MK1

Features

- 360° Fingerprint Recognition
- New Generation Semiconductor Sensor
- New Intelligent High Speed Processor
- Easy Installation

- Eco Battery Technology
- Always Open Technology
- Low Battery Reminder
- Emergency Powerbank Slot
- Minimalist Design
- Multi User Support (Up to 20 user)

Handle Dimension

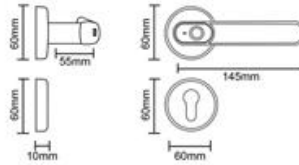

Mortise Dimension

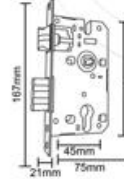

10 YEAR WARRANTY
FOR MORTISE MECHANICAL

2 YEAR WARRANTY
FOR FINGERPRINT READER



EDLK-MK1

Features

- 360° Fingerprint Recognition
- New Generation Semiconductor Sensor
- New Intelligent High Speed Processor
- Easy Installation
- Eco Battery Technology

- Always Open Technology
- Low Battery Reminder
- Emergency Powerbank Slot
- Minimalist Design
- Anti Scratch Pinpad
- Lift Handle to Lock
- Multi User Support (Up to 300 user)

Handle Dimension

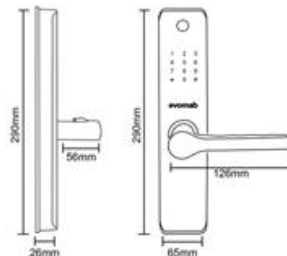

Mortise Dimension

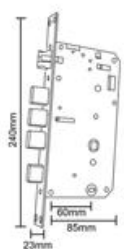

For Main Door

10 YEAR WARRANTY
FOR MORTISE MECHANICAL

2 YEAR WARRANTY
FOR FINGERPRINT READER



EDLK-MK2

Features

- 360° Fingerprint Recognition
- New Generation Semiconductor Sensor
- New Intelligent High Speed Processor
- Easy Installation
- Eco Battery Technology
- Bell Button
- Low Battery Reminder

- Emergency Powerbank Slot
- Minimalist Design
- Anti Scratch Pinpad
- Rechargeable Battery
- Lock From Outside
- OLED Display
- Outdoor Ready
- Multi User Support (Up to 300 user)

Handle Dimension

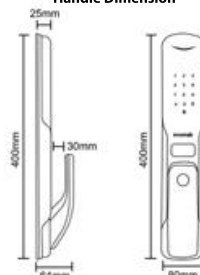

Mortise Dimension

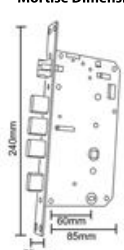

For UPVC / Aluminium Door

EDLK-MK3

Features

- 360° Fingerprint Recognition
- New Generation Semiconductor Sensor
- New Intelligent High Speed Processor
- Easy Installation
- Eco Battery Technology
- Always Open Technology

- Low Battery Reminder
- Emergency Powerbank Slot
- Minimalist Design
- Anti Scratch Pinpad
- Lift Handle to Lock
- Designed for UPVC and Aluminium Door
- Multi User Support (Up to 300 user)

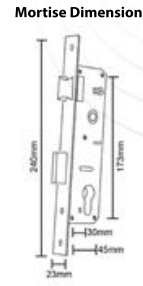
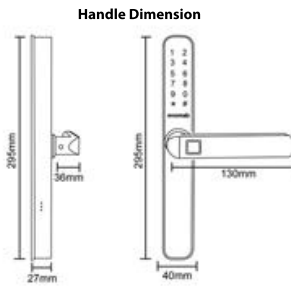

10 YEAR WARRANTY
FOR MORTISE MECHANICAL

2 YEAR WARRANTY
FOR FINGERPRINT READER



10 YEAR WARRANTY
FOR MORTISE MECHANICAL

2 YEAR WARRANTY
FOR FINGERPRINT READER



EDLK-MK4

Features

- Wi-Fi Connection with App
- 360° Fingerprint Recognition
- New Generation Semiconductor Sensor
- New Intelligent High Speed Processor
- Lock & Unlock Record
- Real Time Push Notification
- Easy Setting from App
- Eco Battery Technology

- Temporary Password for Guest
- Low Battery Reminder
- Encrypted Network
- Emergency Powerbank Slot
- Minimalist Design
- Anti Scratch Pinpad
- Always Open Technology
- Lift Handle to Lock
- Intelligent Link to Other Smart Device
- Multi User Support (Up to 300 user)

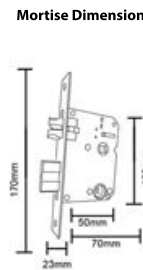
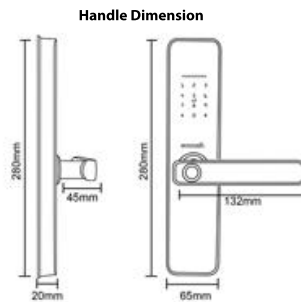

EDLK-MK5

Features

- Bluetooth Connection with App
- 360° Fingerprint Recognition
- New Generation Semiconductor Sensor
- New Intelligent High Speed Processor
- Lock & Unlock Record
- Easy Setting from App
- Eco Battery Technology

- Temporary Password for Guest
- Low Battery Reminder
- Encrypted Network
- Emergency Powerbank Slot
- Minimalist Design
- Anti Scratch Pinpad
- Always Open Technology
- Lift Handle to Lock
- Multi User Support (Up to 300 user)

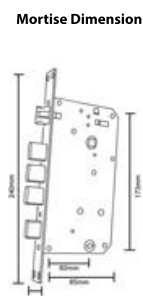
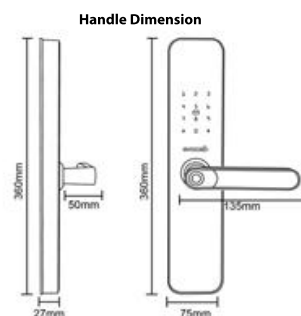

10 YEAR WARRANTY
FOR MORTISE MECHANICAL

2 YEAR WARRANTY
FOR FINGERPRINT READER



For Glass Door

10 YEAR WARRANTY
FOR MORTISE MECHANISM

2 YEAR WARRANTY
FOR FINGERPRINT READER



Fingerprint



Pin Code



Key Tag



EDLG-MK1

Features

- 360° Fingerprint Recognition
- New Generation Semiconductor Sensor
- New Intelligent High Speed Processor
- Easy Installation
- Eco Battery Technology
- Low Battery Reminder
- Always Open Technology

- Low Battery Reminder
- Emergency Powerbank Slot
- Minimalist Design
- Anti Scratch Pinpad
- Attendance Machine Mode (Up to 100.000 Data Record)
- Biggest Full Color LCD Screen
- Up to 18mm Glass Thickness
- Multi User Support (Up to 1000 user)

Body Dimension

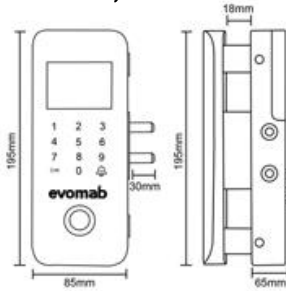

Strike Dimension

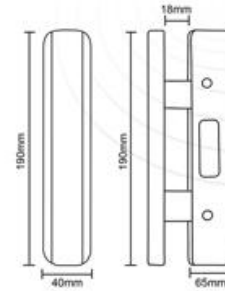

For Furniture or Locker

3 YEAR WARRANTY
FOR CARD READER



Key Tag



RFID Bracelet



EDLL-MK1

Features

- Easy Installation
- New Intelligent High Speed Processor
- Eco Battery Technology
- Low Battery Reminder
- Emergency Powerbank Slot
- Minimalist Design

Sensor Dimension

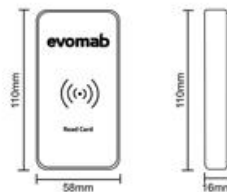

Mortise Dimension

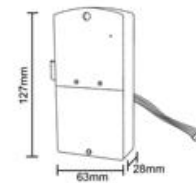

3

IP CCTV

2 YEAR WARRANTY
FOR MANUFACTURING DEFECT



EIPC-STD1

Features

- 2MP Ultra Wide Camera
- Full High Definition 1080p
- Ultra Clear Night Vision
- Motion Detector
- Auto Looping Record
- Support Up to 128GB Memory Card
- Real Time Push Notification
- Minimalist Design
- Adjustable Angle Position
- Encrypted Network
- Automation Support
- Two Way Audio
- Built in Mic & Speaker
- Auto Infra Red Cut
- Multi User Viewing
- Multi Platform View
- Intelligent Link to Other Smart Device
- Cloud Storage Ready

Product Dimension

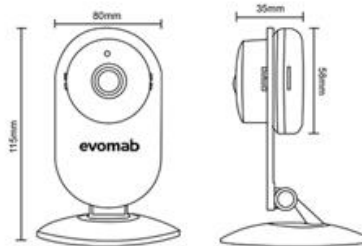

EIPC-PTZ1

Features

- 360° PTZ (Pan-Tilt-Zoom) Camera
- 2MP Ultra Wide Camera
- Full High Definition 1080p
- Ultra Clear Night Vision
- Motion Detector
- Auto Looping Record
- Support Up to 128GB Memory Card
- Real Time Push Notification
- Minimalist Design
- Encrypted Network
- Automation Support
- Two Way Audio
- Built in Mic & Speaker
- Auto Infra Red Cut
- Multi User Viewing
- Multi Platform View
- Intelligent Link to Other Smart Device
- Cloud Storage Ready

Product Dimension

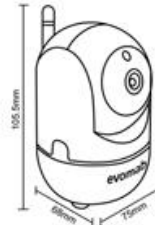

2 YEAR WARRANTY
FOR MANUFACTURING DEFECT



Sensor & Alarm

2 YEAR WARRANTY
FOR MANUFACTURING DEFECT



ESNA-UIRC1

Features

- 360° Infra Red Beam Coverage
- Control Almost All Remote Electronic Item
- Infra Red Beam Up to 10 meters
- Minimalist Design
- Low Power Consumption
- Set Timer Support
- Automation Support
- Encrypted Network
- Multi User Support
- Multi Platform Controlled
- Intelligent Link to Other Smart Device
- Intelligent DIY Learning Function
- Voice Control Support

Product Dimension



Sensor & Alarm

2 YEAR WARRANTY
FOR MANUFACTURING DEFECT



ESNA-DWS1

Features

- Detect Open & Close Instantly
- Encrypted Network
- Applicable For Door & Window
- 24 Hours Standby Time
- Powered by 2 x 1.5V AAA Battery
- Low Power Consumption
- Real Time Push Notification
- Minimalist Design

- Open & Close Data Record
- Low Battery Notification
- Automation Support
- Intelligent Link to Other Smart Device
- Voice Control Ready

Product Dimension

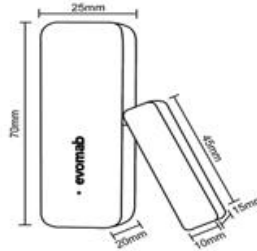

2 YEAR WARRANTY
FOR MANUFACTURING DEFECT



ESNA-WLS1

Features

- Detect Water Level or Leaked Instantly
- Encrypted Network
- 24 Hours Standby Time
- Powered by 2 x 1.5V AAA Battery
- Low Power Consumption
- Real Time Push Notification
- Minimalist Design

- Low Battery Notification
- Automation Support
- Intelligent Link to Other Smart Device
- Voice Control Ready

Product Dimension

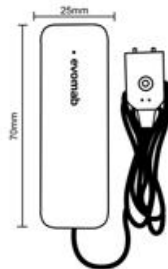

2 YEAR WARRANTY
FOR MANUFACTURING DEFECT



ESNA-MTS1

Features

- 110° Motion Detection Angle
- Detect Motion Up to 10 meters
- Adjustable Angle Position
- Minimalist Design
- 24 Hours Standby Time
- Powered by 1 x 3V CR123A Battery
- Real Time Push Notification

- Low Power Consumption
- Encrypted Network
- Low Battery Notification
- Automation Support
- Intelligent Link to Other Smart Device
- Voice Control Ready

Product Dimension

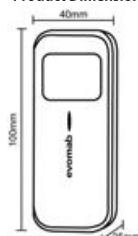

2 YEAR WARRANTY
FOR MANUFACTURING DEFECT



ESNA-SRN1

Features

- 90dB Very Loud Alarm
- 10 Types of Alarm & Ringtone
- Dual Power (USB Charge & Battery)
- Emergency Power by Battery
- Minimalist Design
- 24 Hours Standby Time
- Use 2 x 3V CR123A Battery
- Real Time Push Notification
- Blinking LED Lamp
- Low Power Consumption
- Encrypted Network
- Low Battery Notification
- Automation Support
- Intelligent Link to Other Smart Device
- Voice Control Ready

Product Dimension

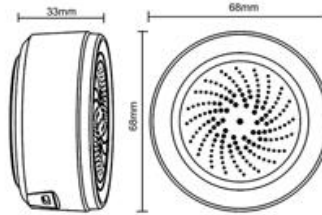

Switch & Plug

1 YEAR WARRANTY
FOR MANUFACTURING DEFECT



ESNP-SWS1 | ESNP-SWS2 | ESNP-SWS3 (White)

Features

- Capacitive Touchscreen
- Encrypted Network
- Thick ABS Case
- Tempered Glass Panel
- EU Standard
- Luxurious Appearance
- Fire Resistant Material
- Electrical Overload Protection
- LED Illuminated Button
- Automation Support
- Intelligent Link to Other Smart Device
- Voice Control Ready

Product Dimension

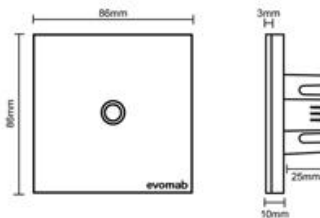

6

1 YEAR WARRANTY
FOR MANUFACTURING DEFECT



ESNP-SWS1 | ESNP-SWS2 | ESNP-SWS3 (Black)

Features

- Capacitive Touchscreen
- Encrypted Network
- Thick ABS Case
- Tempered Glass Panel
- EU Standard
- Luxurious Appearance
- Fire Resistant Material
- Electrical Overload Protection
- LED Illuminated Button
- Automation Support
- Intelligent Link to Other Smart Device
- Voice Control Ready

Product Dimension

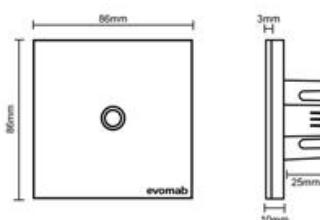

evomab[®]
S M A R T H O M E

Tersedia di:



QHOMEMART

**JL.RAYA JANTI NO.96 YOGYAKARTA
(0274) 493 22 88 , 08112863773 (CHAT ONLY)**

f qhomemart t qhomemart @ qhomemart v qhomemart

WWW.QHOMEMART.COM