

ANGZ DOORS & WINDOWS

E-CATALOG 2022

angz.commetz

HUBUNGI :  QHOMEMART

08112863773
CHAT ONLY

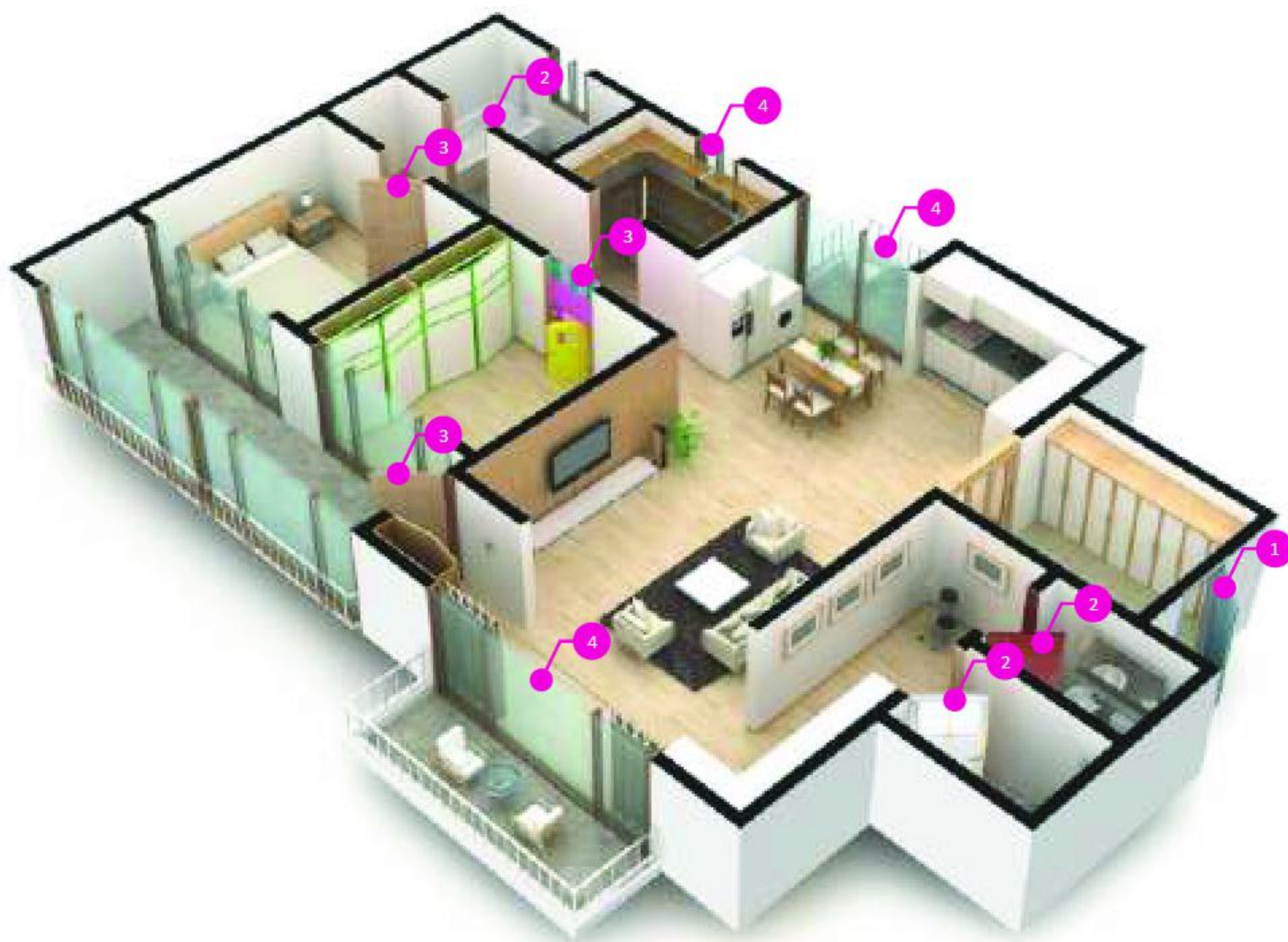

1

PINTU RUANG TAMU/ DEPAN

BARRINGTON STEEL DOOR SERIES
FORTE STEEL

2

PINTU KAMAR MANDI

WEATHERPRO SERIES
WPC SERIES

3

PINTU RUANGAN

MOLDED PANEL SERIES
GROOVE SERIES
LAMINATE SERIES

4

JENDELA

UPVC DOORS & WINDOWS

EXTERIOR DOOR SERIES



BARRINGTON Steel Door

Pintu baja komplit set memiliki keunggulan antara lain pemasangan dan perawatan mudah, memiliki sistem keamanan ganda (dilengkapi 13 kunci), kuat, tahan lama, dan tahan karat dengan 4 pilihan design serta warna yang menarik. Pintu ini sudah dilengkapi kusen, engsel, handle & door viewer (komplit set). Sehingga pintu ini cocok digunakan untuk pintu depan.

SPESIFIKASI

Dimensi dengan kusen	100x970x2050 mm
Berat	48 Kg
Finishing	Powder Coating
Tebal plat kusen	1,5 mm
Tebal plat pintu	0,7 mm
Garansi	1 Tahun



STLD 01



STLD 02



STLD 03



STLD 04

Keunggulan pintu steel door Barrington :

- Memiliki sistem keamanan ganda (dilengkapi 13 kunci)
- Pemasangan dan perawatan mudah
- Kusen baja ber-architave, dilengkapi karet peredam
- Kuat dan tahan lama
- Dengan 4 pilihan design & warna yang menarik
- Tahan karat
- Komplit set (kusen, engsel, pintu, door viewer dan handle)
- Tebal plat daun pintu 0,6mm dan tebal kusen pintu 1,5mm
- Ambang pintu stainless steel
- Finishing powder coating

EXTERIOR DOOR



STEEL DOOR

Keunggulan FORTE STEEL:

- Pemasangan dan perawatan mudah
- Harga lebih hemat dibanding pintu baja lainnya
- Design mewah
- Dapat di cat ulang sesuai selera
- Komplit set (kusen, engsel, pintu, dan handle)
- Bahan plat baja tebal 0,5mm dan frame 0,8mm
- Finishing powder coating

PILIHAN DESIGN

UK PINTU + KUSEN 100 x 880 x 2160mm



FORTE C-01
WHITE

FORTE C-01
WALNUT

FORTE C-03
WHITE

FORTE C-03
WALNUT

KUSEN KNOCK DOWN



Cara pemasangan kusen :

- 01. Setting kiri dan kanan potongan kusen sesuai arah bukaan yang diinginkan.
- 02. Sambungkan kait pengunci pada lubang yang sudah disiapkan



DESIGN **HANDLE**
MODERN
MINIMALIS



INTERIOR DOOR



WEATHERPRO

Aluminium door

Pintu dan kusen dari bahan Aluminium yang tahan terhadap kelembaban dan air, serta rayap dan jamur. Mempunyai desain yang estetis, dapat digunakan sebagai pintu kamar maupun kamar mandi.

Telah dilengkapi dengan kusen & accessories (kunci, handle dan engsel)

SPESIFIKASI

Lebar	700 mm / 690 mm (Untuk Tipe B1, B2, B3)
Tinggi	2000 mm
Berat	25 Kg
Finishing	Champagne/ White
Bahan	Aluminium
Garansi	1 Tahun

● **READY STOCK**



A-1 CPE

A-2 CPE

A-3 CPE

A-4 CPE

A-22 CPE

A-23 WTE

A-24 CPE



A-25 WTE/ CPE

A-29 WTE/ CPE

AP 1

B 1 WTE/ CPE

B 2 WTE/ CPE

B 3 WTE/ CPE

INTERIOR DOOR SERIES



WOOD PLASTIC COMPOSITE DOOR (WPC)

Adalah pintu interior dari bahan Wood Plastic Composites (WPC), yang merupakan gabungan antara serat selulosa alam seperti serat/ serbuk kayu, sekam padi, batang tebu dan polimer/ plastik (vinyl) baik yang masih orisinil ataupun daur ulang. Sehingga memastikan tahan terhadap rayap.

Keunggulan :

- Harga Terjangkau dan Ekonomis
- Pemasangan Cepat dan Mudah
- Tahan Kelembaban
- Anti Rayap dan Hama
- Ramah Lingkungan

SPEC COMPARISON			
	WPC	WPC+	
SIZE	720/ 820/ 920 x 2100mm	700/ 800 x 2100mm	910 x 2100mm
BOARD THICKNESS	3/ 5/ 8mm	5mm	5mm
THICKNESS	38mm	40mm	45mm

WPC+ / WPC

GROOVE STYLE

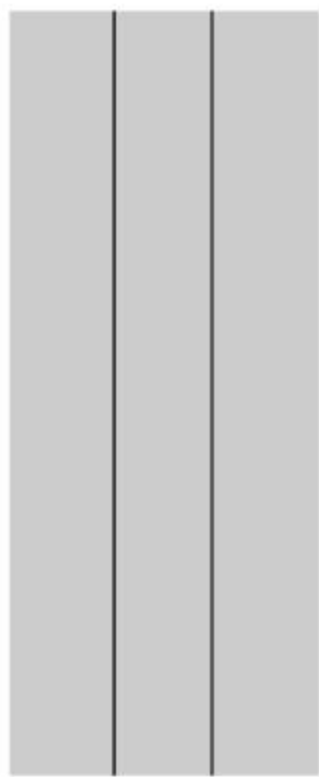

C

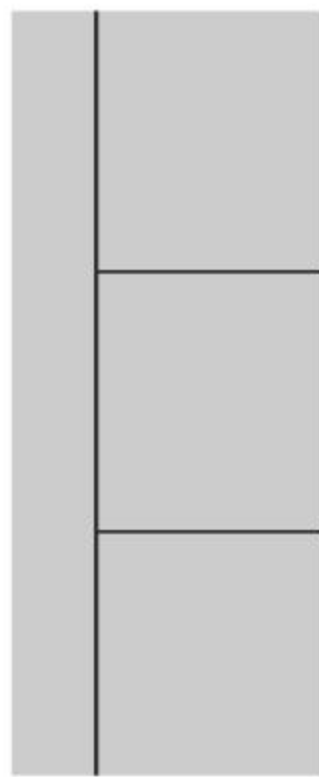

D

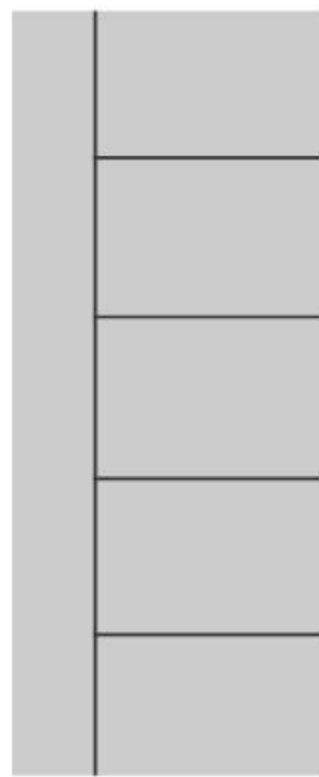

E

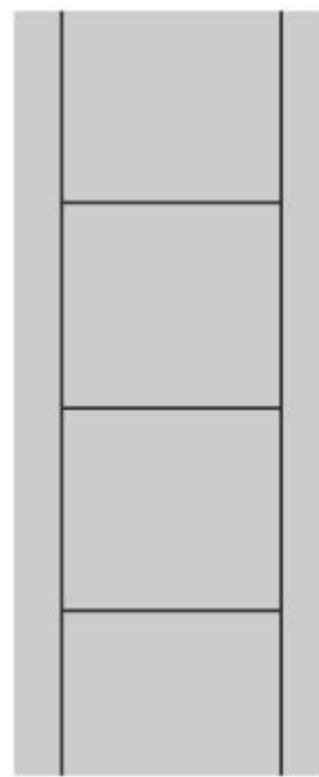

F



G

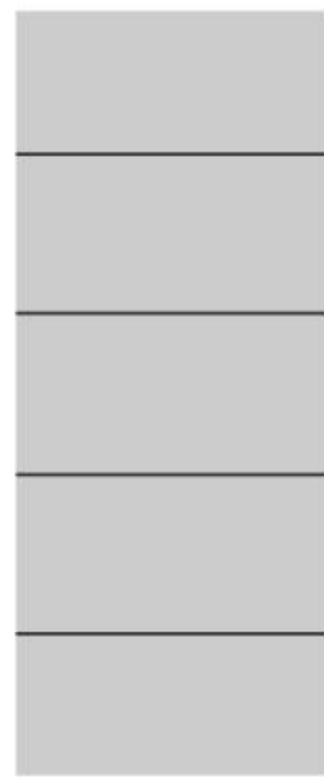

H



I

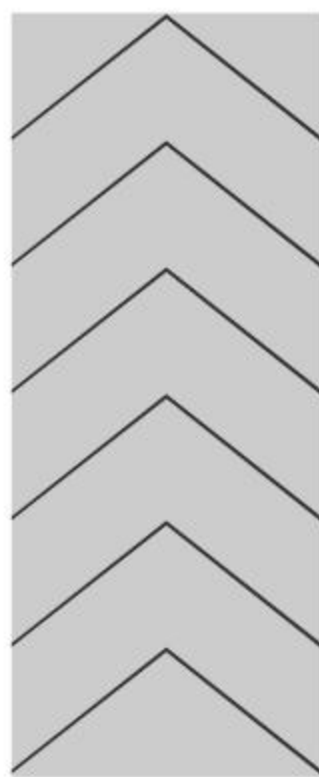

K

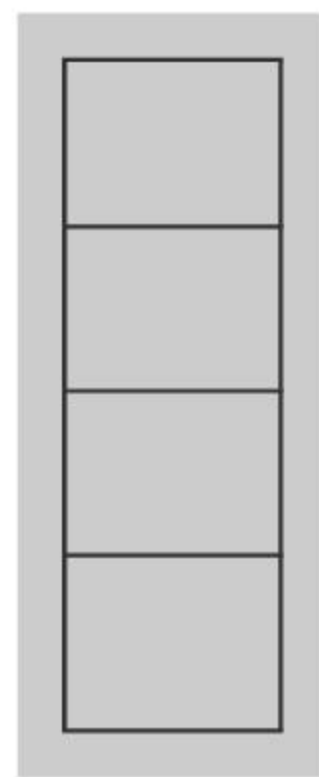

L

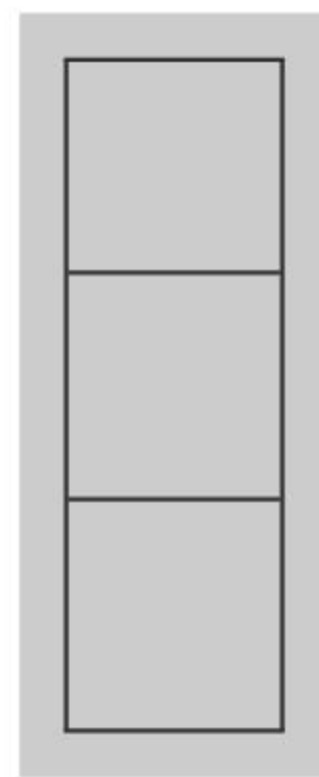

M

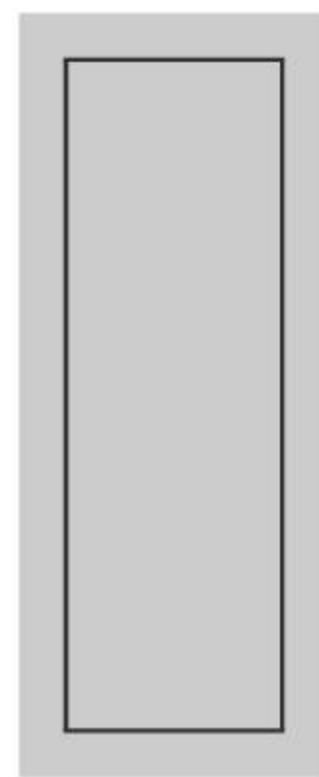

N

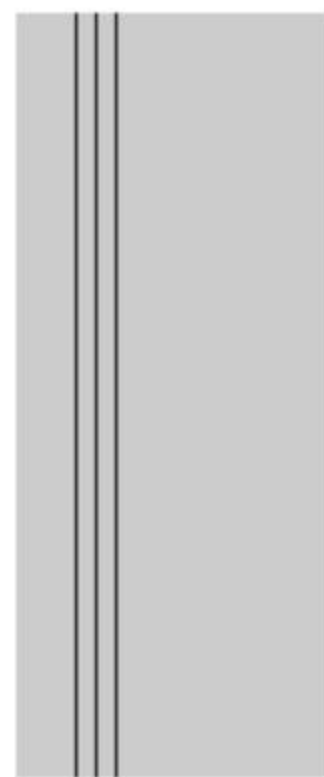

O

WPC+

Wood Plastic Composite Plus



Adalah pintu WPC+ yang sudah dilengkapi kusen dan architrave (set), sehingga bisa lebih hemat dan lebih mudah dalam pemasangannya.

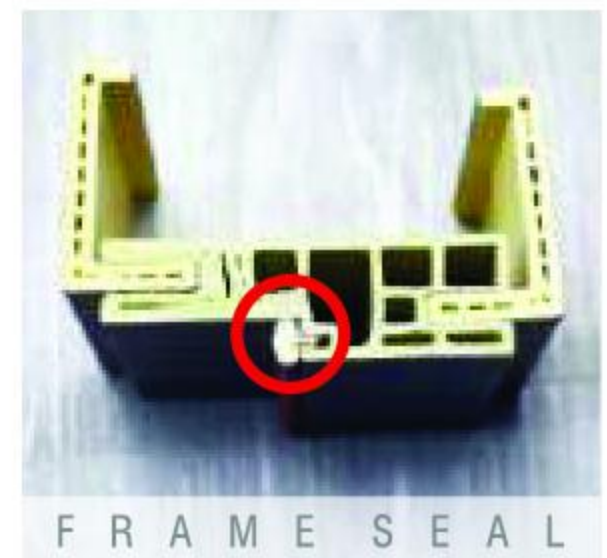

WPC+

DOOR FRAME & DOOR PROFILE

Gambar Profil Pintu

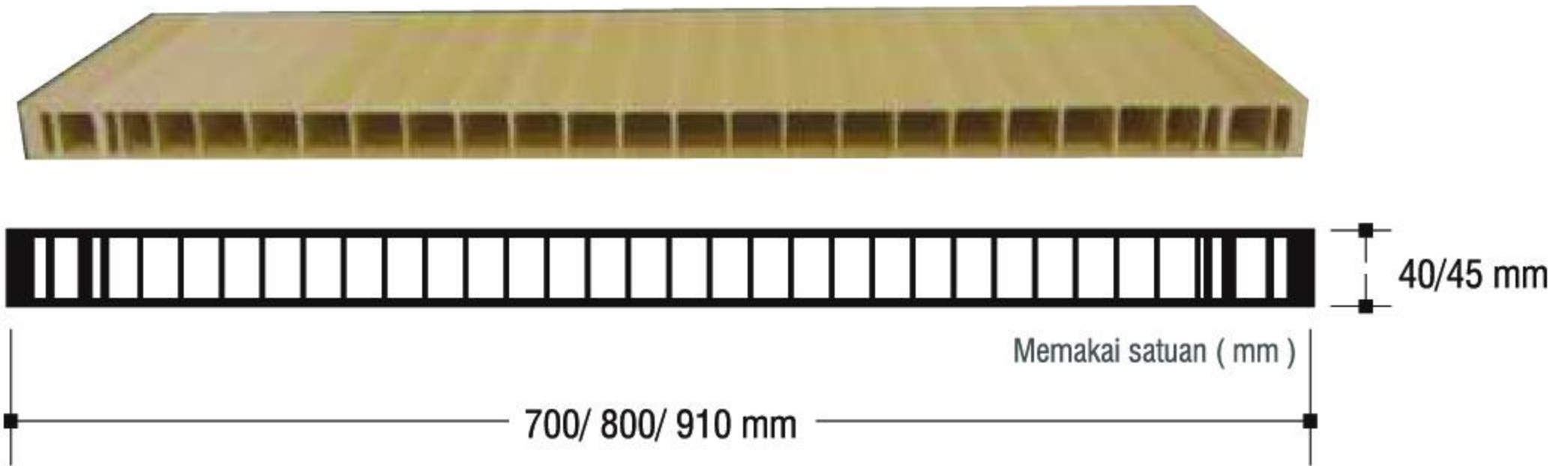

Ilustrasi Pemasangan Kusen + Architrave

Gambar Profil Kusen

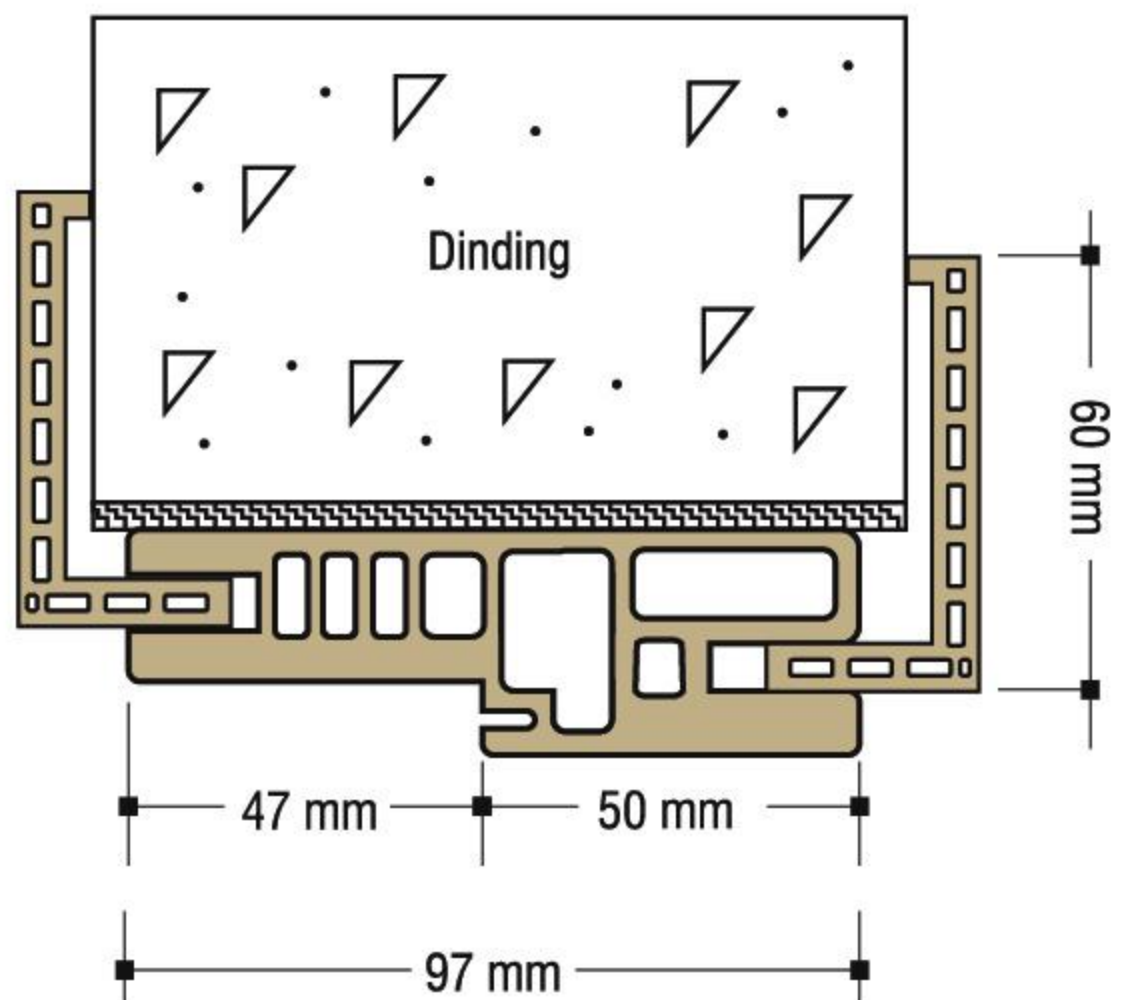
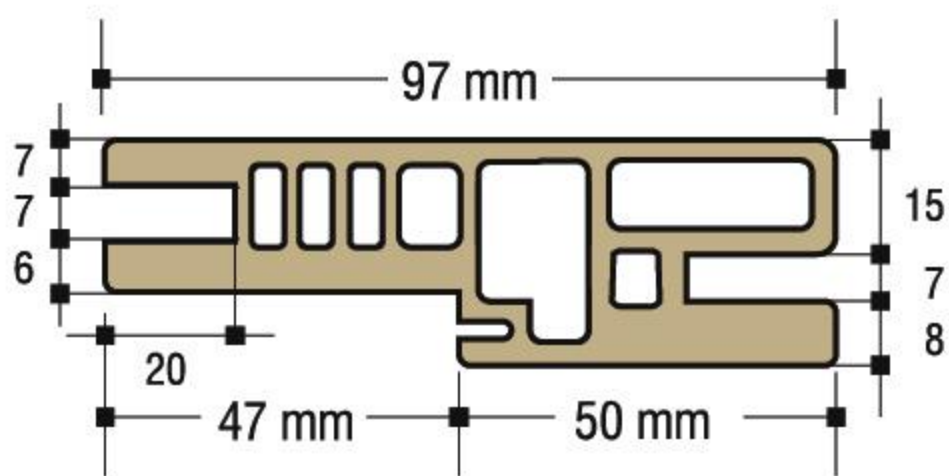

Gambar Profil Architrave

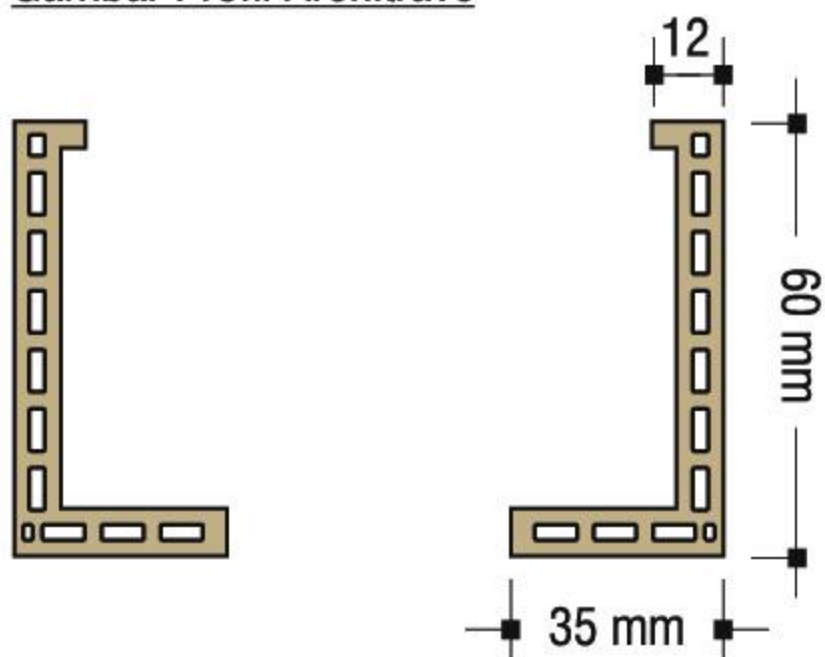

WPC+

LAMINATED DESIGN



P1 W1



P1 W2



P1 W3

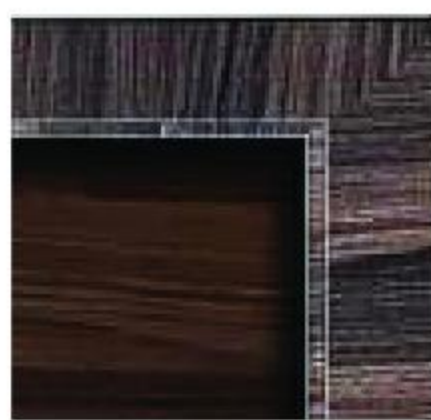

F R A M E S E A L

STANDARD SIZE :

- 40 x 700 x 2100 mm
- 40 x 800 x 2100 mm
- 45 x 910 x 2100 mm

* Tidak dapat dipotong

* Tidak termasuk handle dan engsel

WPC



3mm

Tipe dengan harga paling ekonomis. Cocok digunakan sebagai pintu kamar mandi.



5mm

Tipe paling populer dan banyak digunakan. Cocok digunakan sebagai pintu kamar mandi dan pintu kamar.



8mm

Tipe dengan struktur yang paling kokoh dan kuat. Cocok digunakan sebagai pintu kamar mandi, pintu kamar dan pintu utama.

STANDARD SIZE :

- 38 x 720 x 2100 mm
- 38 x 820 x 2100 mm
- 38 x 920 x 2100 mm

* Tidak dapat dipotong

WPC

DOOR FRAME

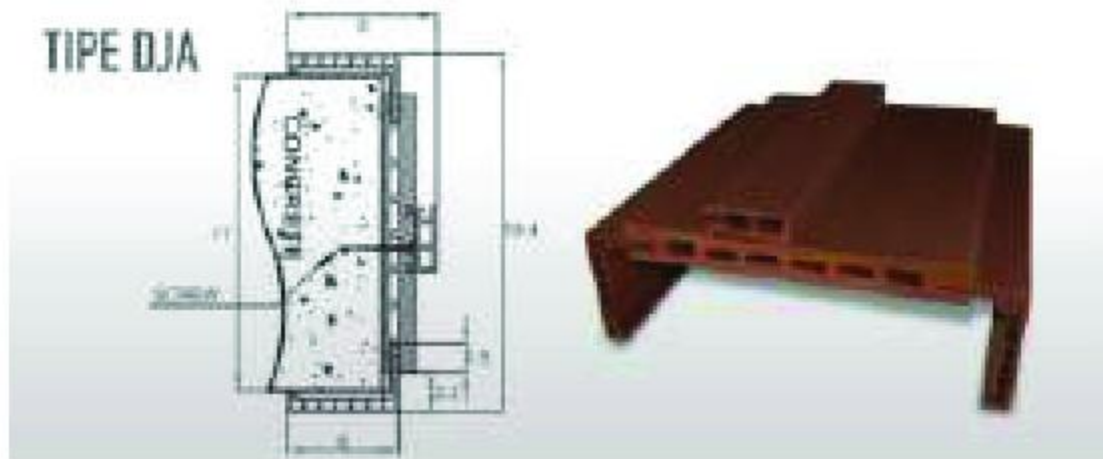

DJA 80x194

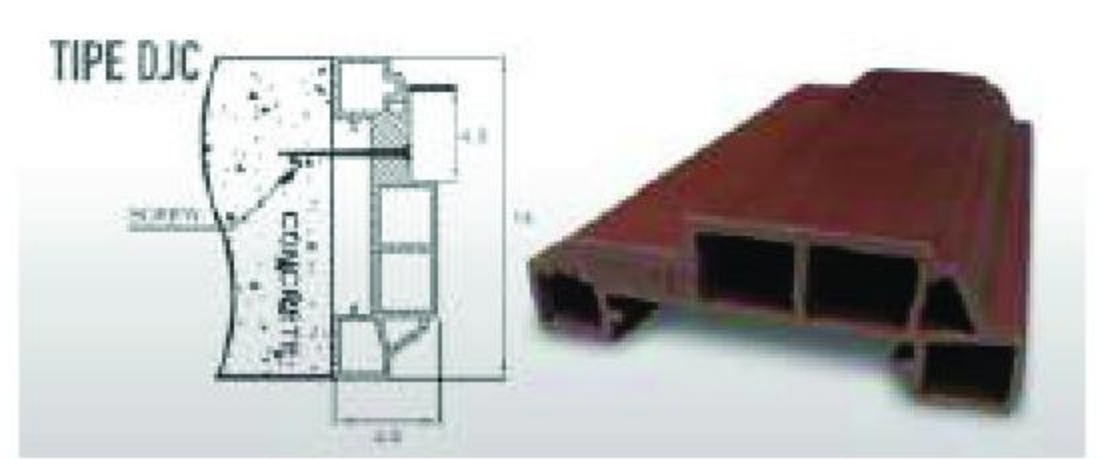

DJC 48x150

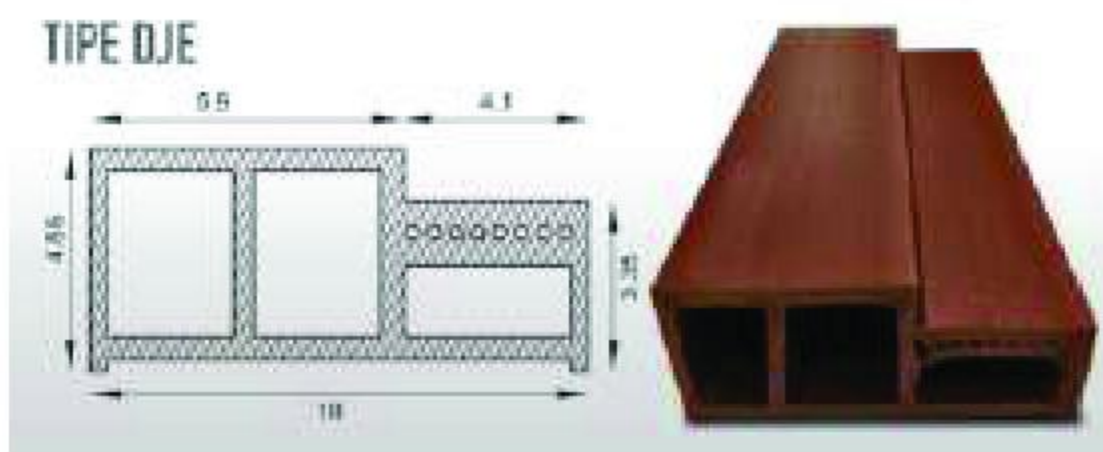

DJE 45x100

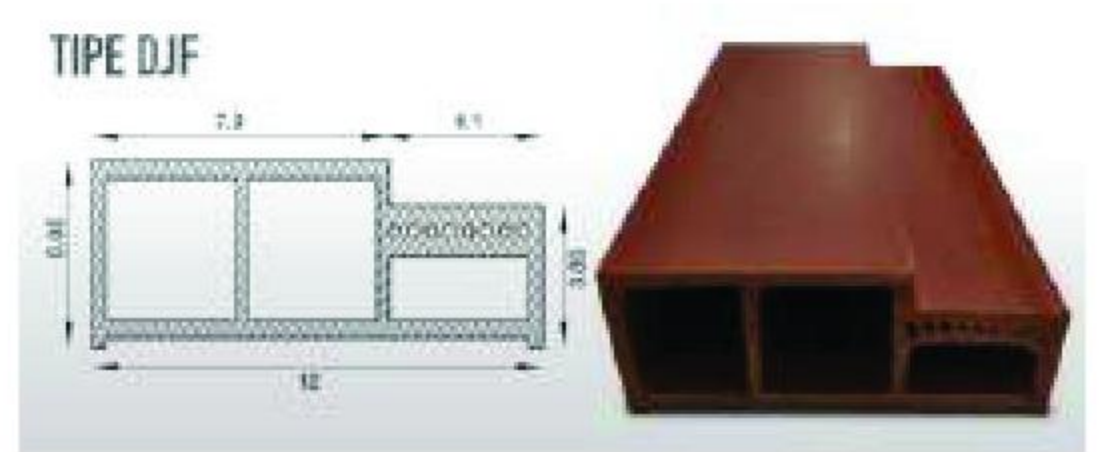

DJF 50x120

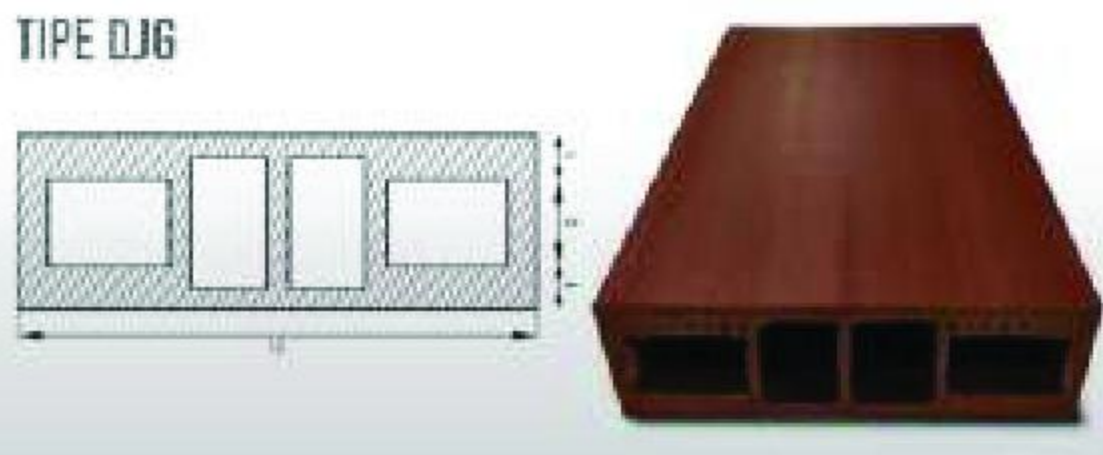

DJG 40x120

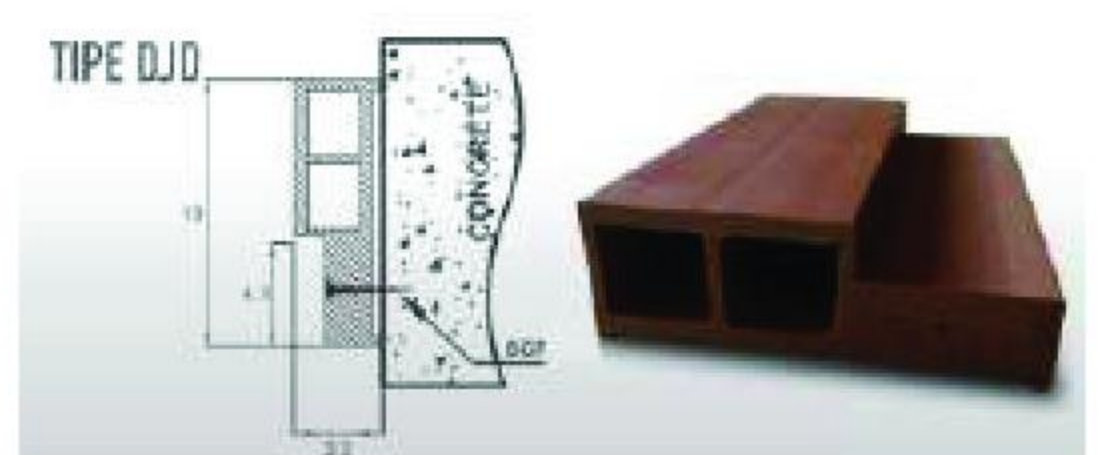

DJD 33x100

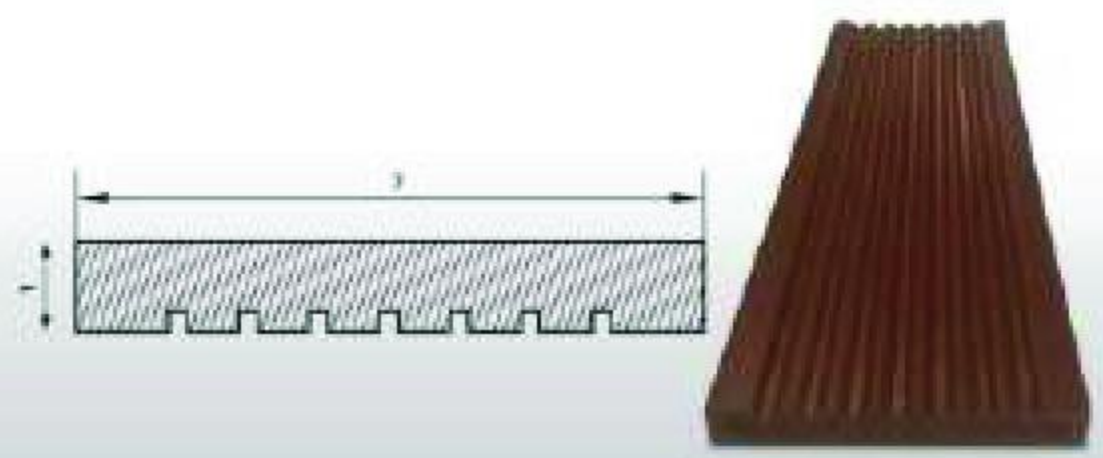

DJX

WPC

SOLID COLOR

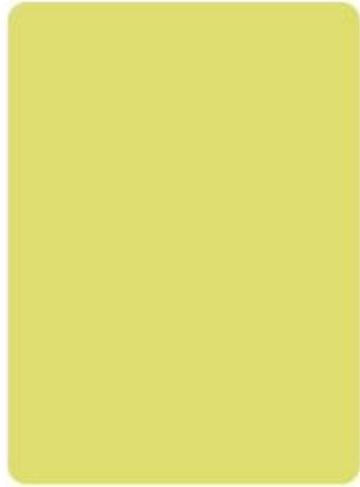

Cream



Light Olive



Ivory

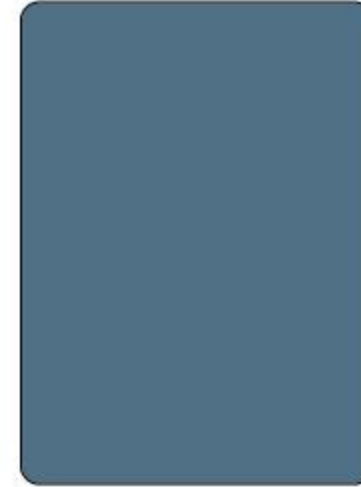

Musagate
Grey

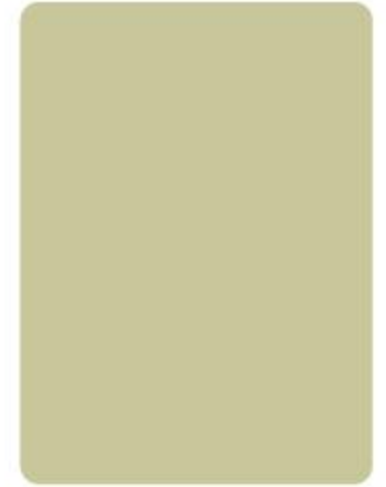

Light Grey



Exclusive
White



Exclusive
Grey



British
Green

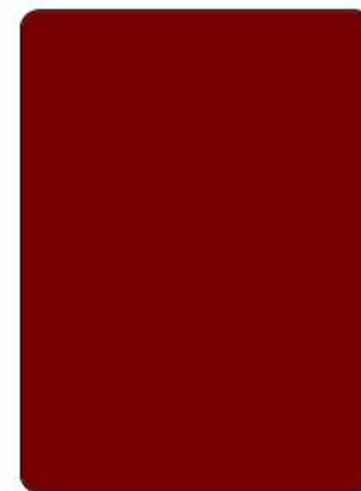

Exotic Red



Black Doff



Copper
Brown



Dark Brown



Havana Brown



Tobacco
Brown



Deep Black

INTERIOR DOOR SERIES

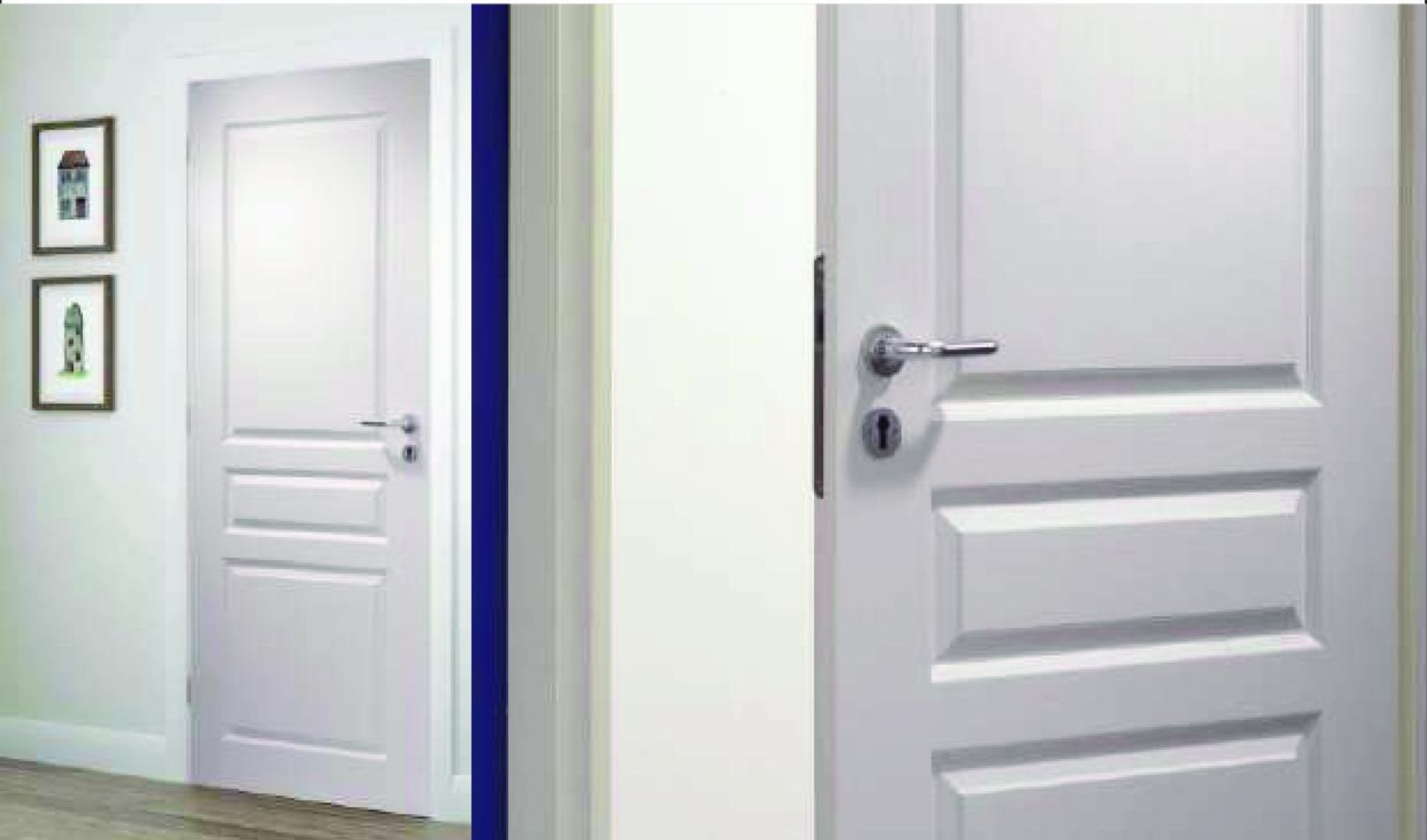

MOLDED PANEL & GROOVE SERIES

1. Silent+ Type

Pintu dengan konstruksi core honeycomb sehingga lebih kedap suara dan dapat dilakukan pemotongan/penyerutan terhadap pintu hingga 5mm pada setiap sisi pintu. Pemasangan pintu yang mudah.



2. Silent Type

Pintu dengan konstruksi core polystyrene dan dapat dilakukan pemotongan/penyerutan 10mm pada setiap sisi pintu. Pemasangan pintu yang mudah.



3. Solid Type (Khusus Tipe Groove Series)

Pintu dengan konstruksi core engineered wood lebih tebal dan rapat sehingga lebih kokoh dapat dilakukan pemotongan/penyerutan 10mm pada setiap sisi pintu. Pemasangan pintu yang mudah.



SPESIFIKASI

Lebar	720/ 820/ 920 mm
Tinggi	2100 mm
Tebal	36 mm
Berat	25 - 40 Kg
Garansi	1 Tahun

MOLDED PANEL DESIGN



2



2B



2M



3



3A



3B



4



4A





4B



4D



5



6*



1



8

* Tersedia smooth khusus 6 panel untuk ukuran maximum lebar 927 x 2140 mm.

- Custom Size Available
- Ready Stock

MOLDED PANEL GLASS & LOUVRE DESIGN

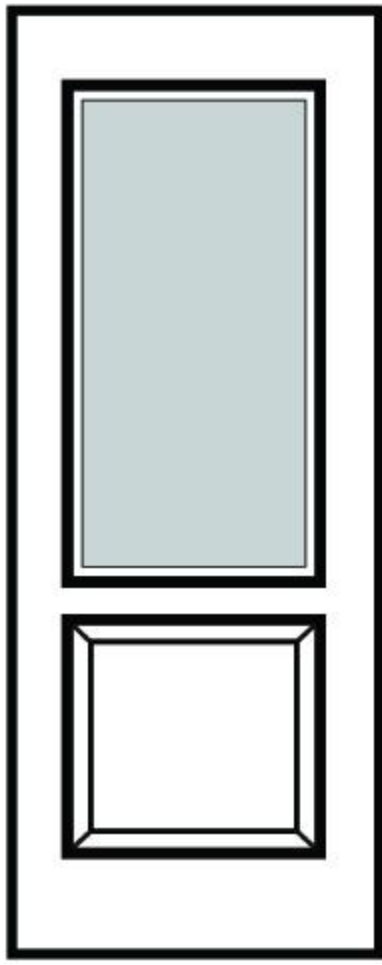

2 GL T

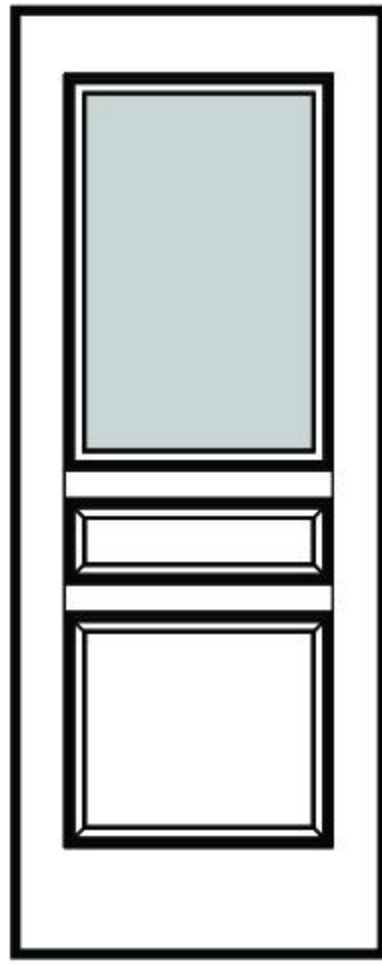

3 GL T

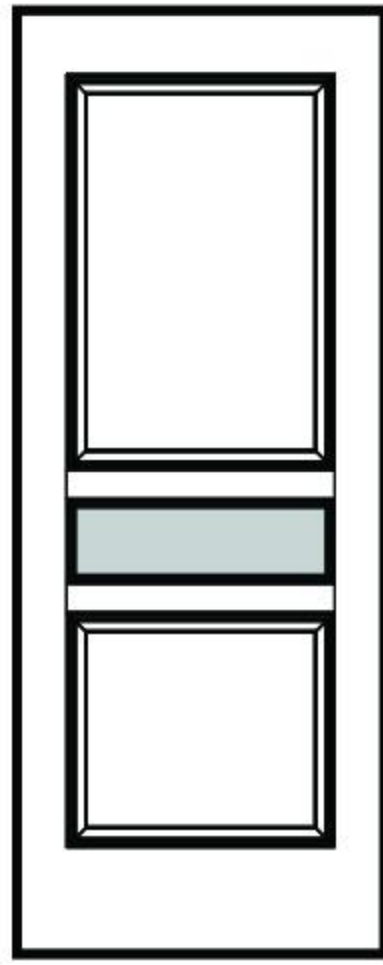

3 GL M

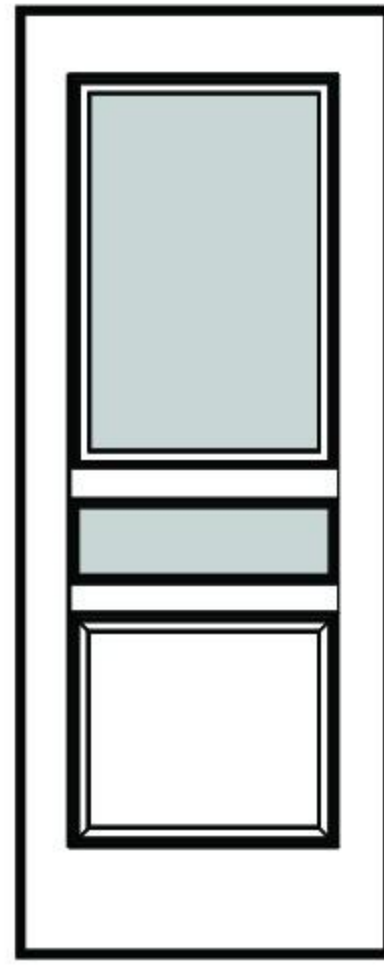

3 GL TM

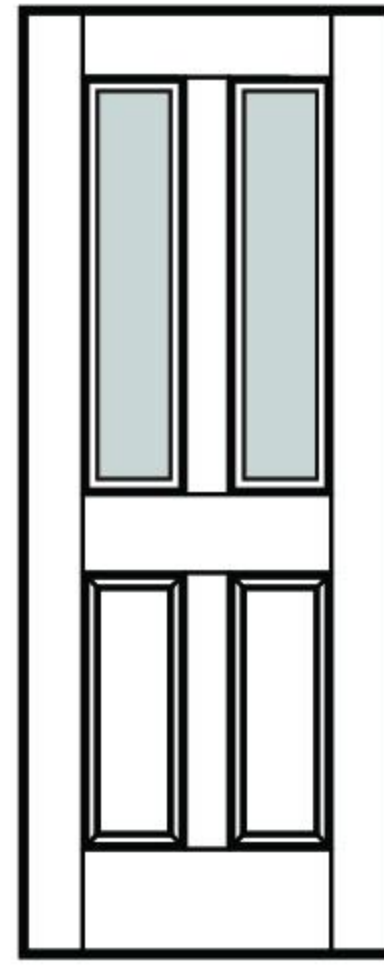

4B GL T

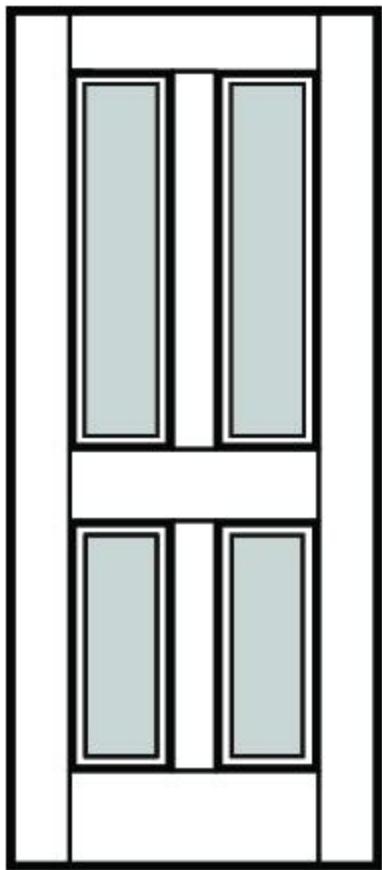

4B GL F

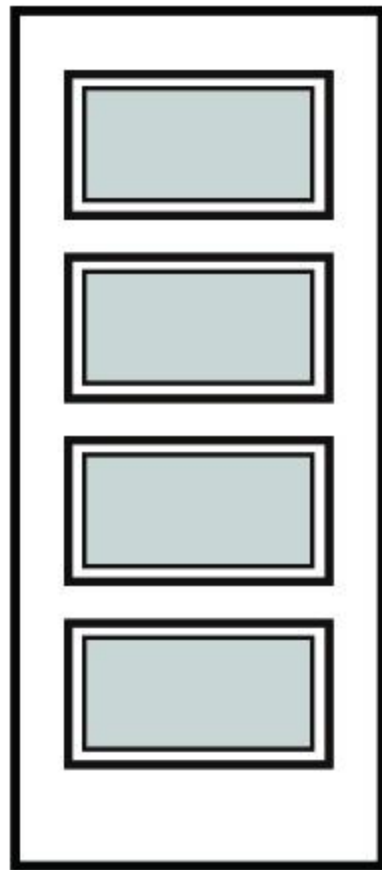

4D GL F

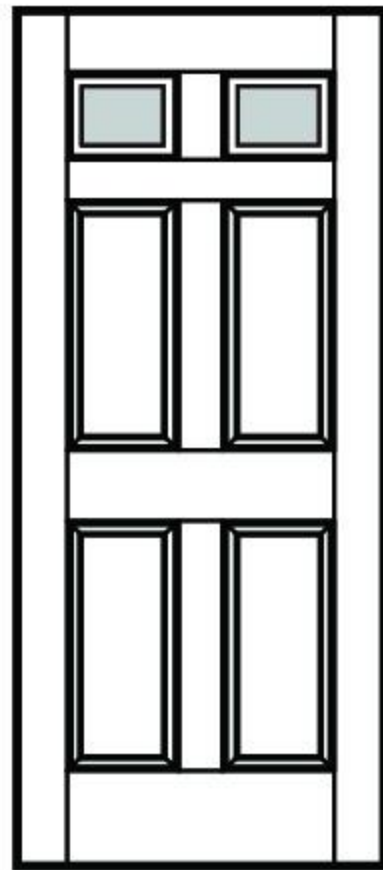

6 GL T

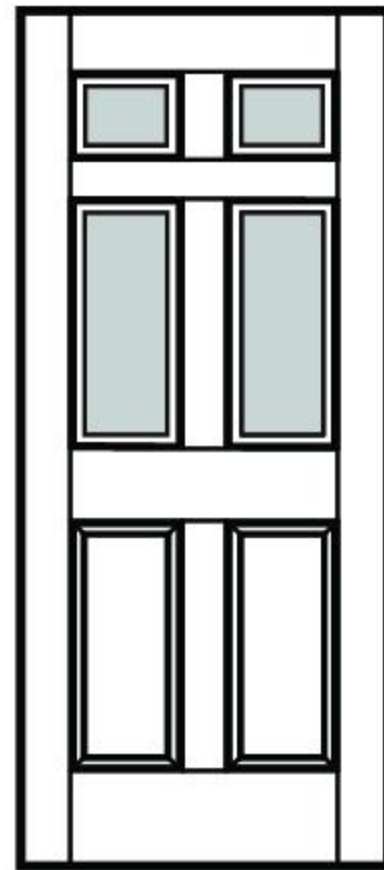

6 GL TM

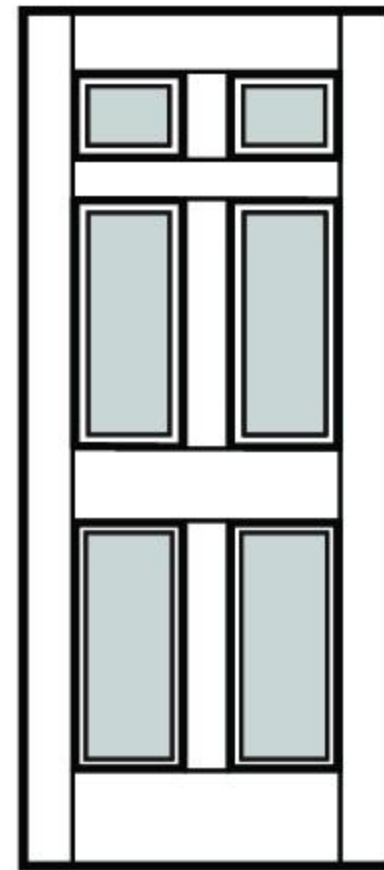

6 GL F

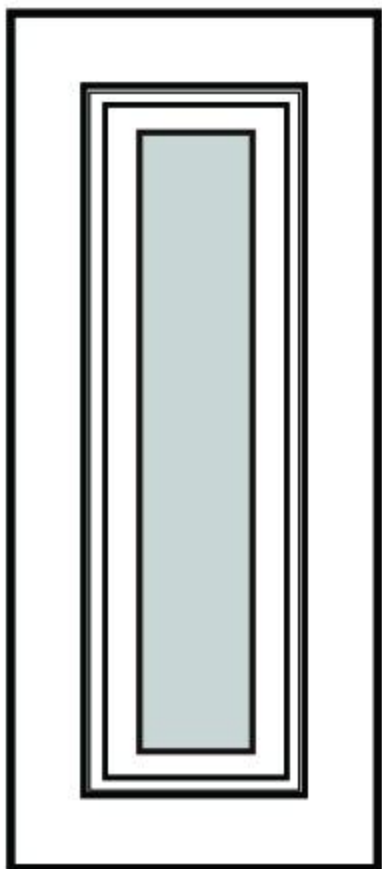

1 GL F

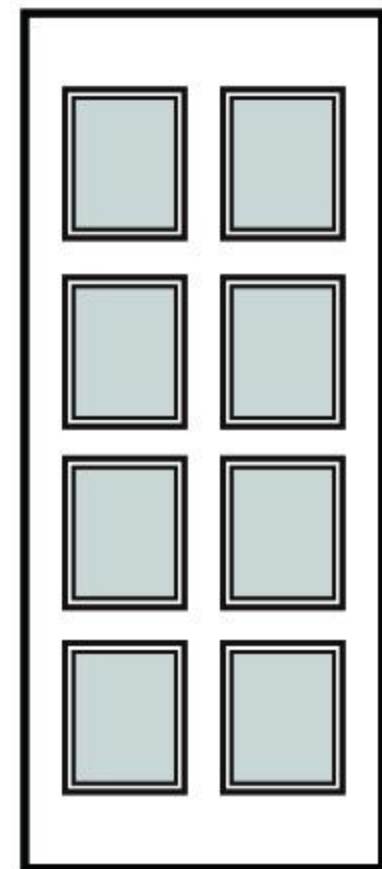

8 GL F

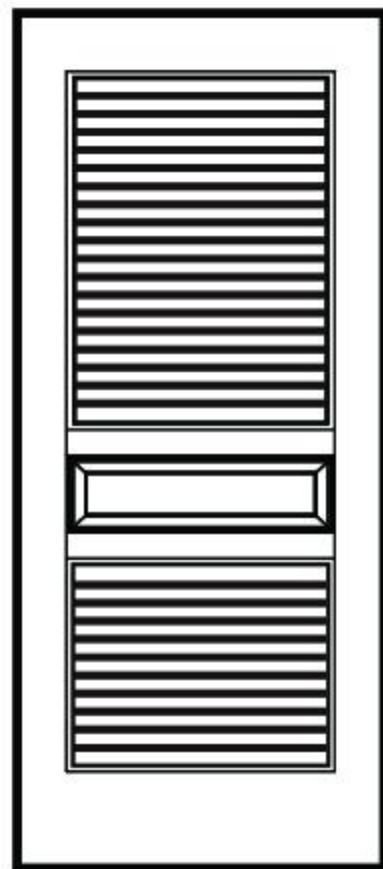

3 LOUVRE TB

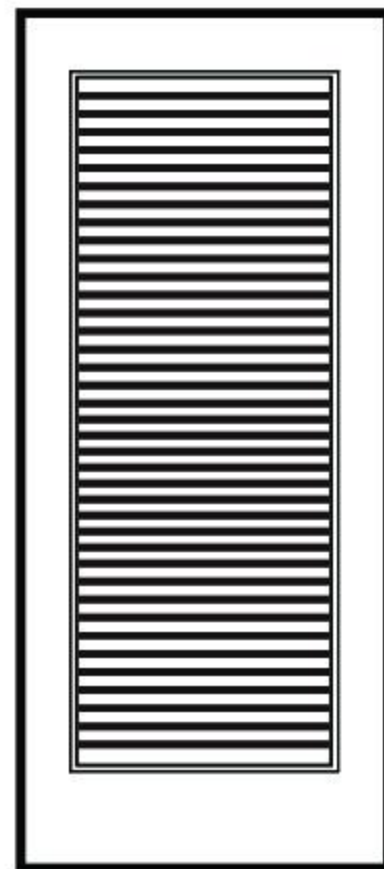

1 LOUVRE F

**NEW
DESIGN**

GROOVE SERIES

Groove Type

Pintu dengan kombinasi router (tali air) pada permukaannya.

STANDARD SIZE :

- 36 x 720 x 2100 mm
- 36 x 820 x 2100 mm
- 36 x 920 x 2100 mm

- Custom Size Available
- Ready Stock

GROOVE DESIGN

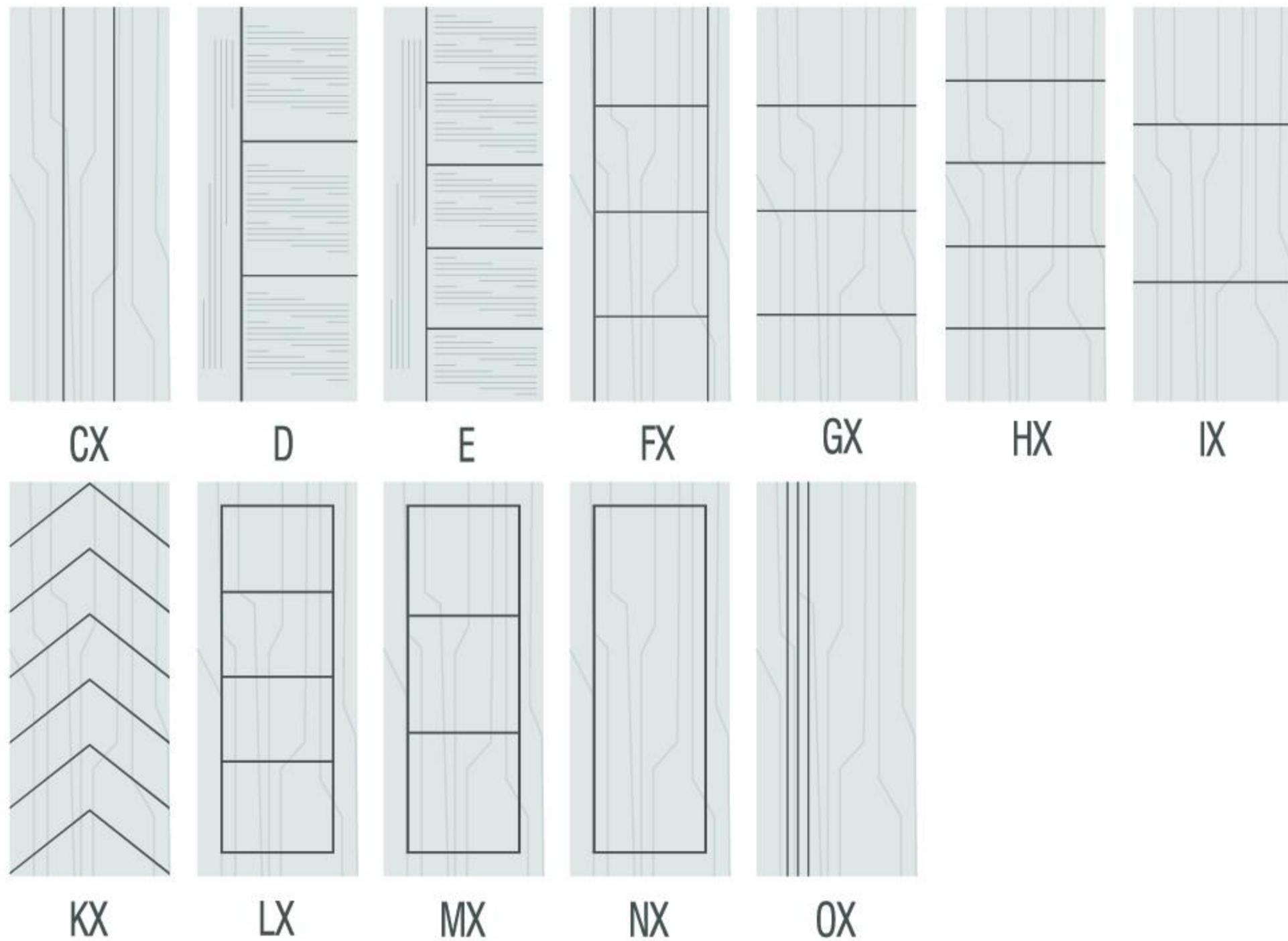

GROOVE GLASS DESIGN

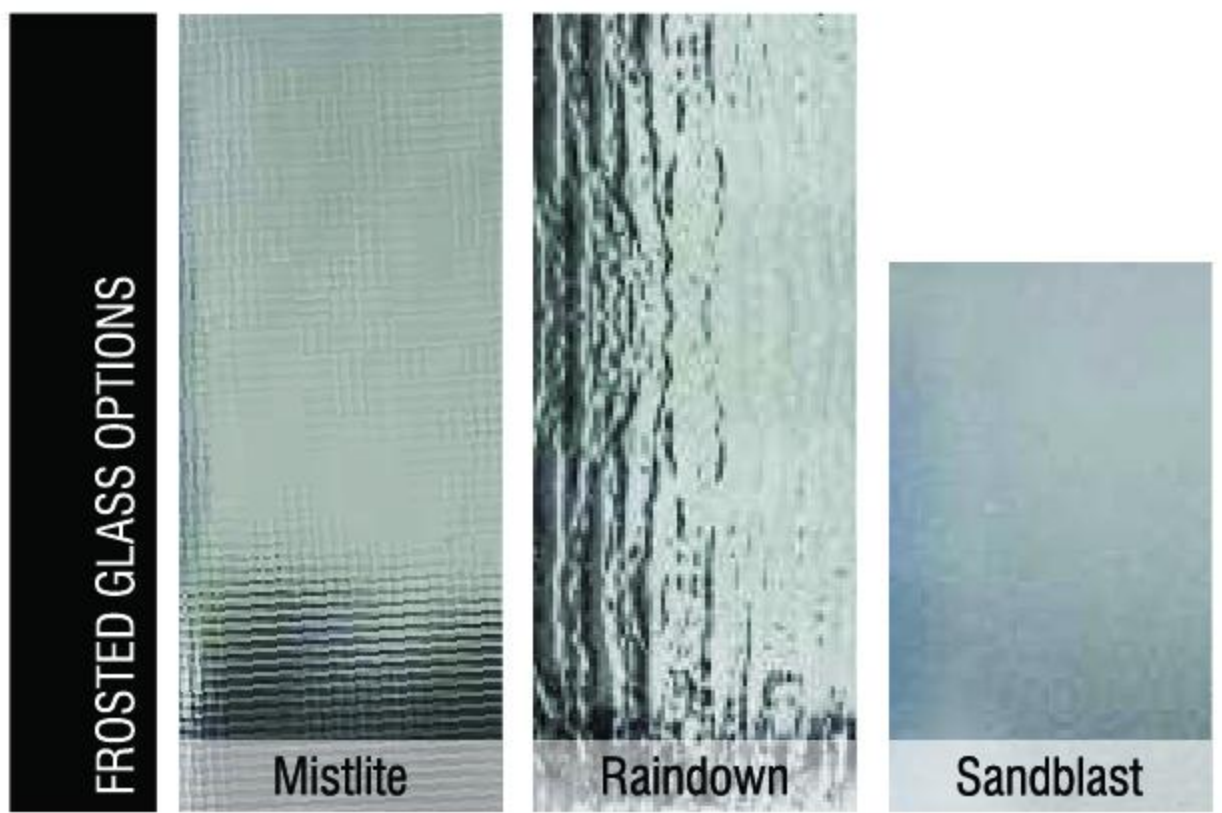
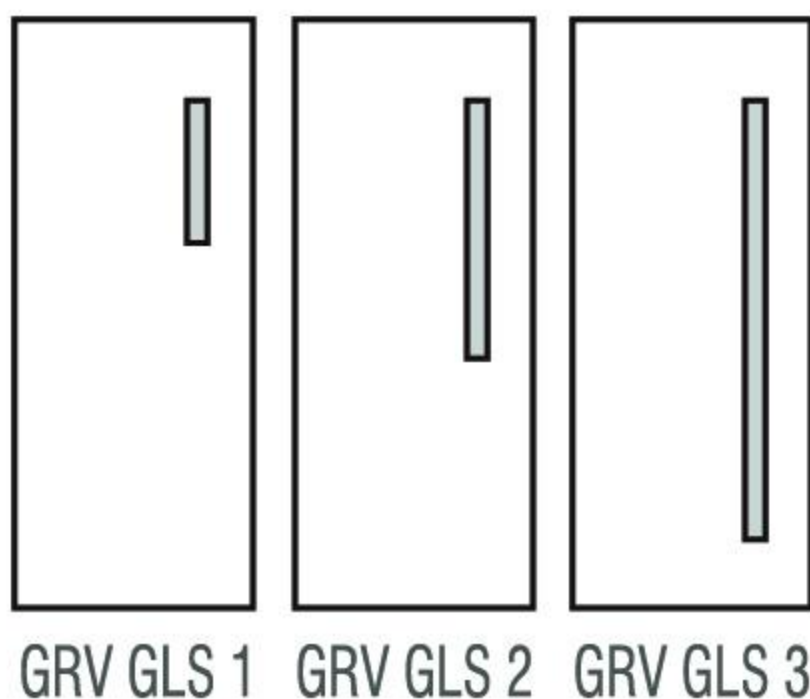

COLOR ALTERNATIVES FOR MOLDED & GROOVE



Cream



Light Olive



Ivory



Musagate
Grey

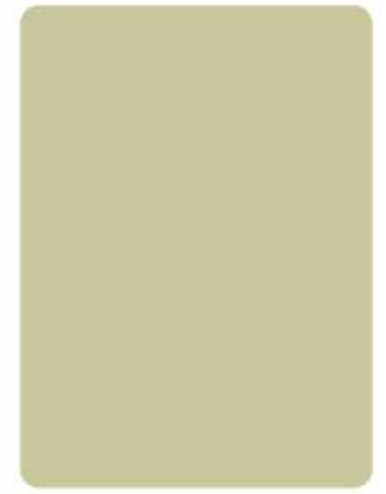

Light Grey

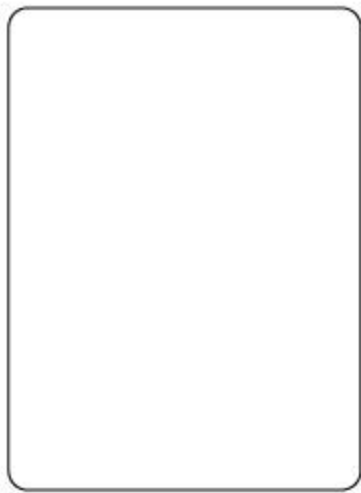

Exclusive
White



Exclusive
Grey



British
Green



Exotic Red



Black Doff



Copper
Brown



Dark Brown



Havana Brown



Tobacco
Brown



Deep Black

MELAMINE & ALUMINIUM SERIES

Pintu HDF untuk kamar mandi yang satu sisinya menggunakan plywood melaminto atau plywood alumunium kulit jeruk, yang relatif tahan terhadap kondisi lembab. Sisi depan tetap menggunakan HDF skin, ini membuat penampilan pintu kamar mandi tetap dapat disesuaikan dengan ruang lain.

Finishing : Plamir/cat dasar dan lapisan melamine 1 sisi/ Lapisan alumunium kulit jeruk 1 sisi.

SPESIFIKASI

Lebar	720 mm
Tinggi	2100 mm
Tebal	36 mm
Berat	25 Kg
Finishing depan	Prime (Water base)
Finishing belakang	Aluminium/ Melamine
Garansi	1 Tahun



melamine



aluminium

INTERIOR DOOR SERIES



Laminate Door

Pintu laminate **ANGZDÖRR** menggunakan lapisan dasar HDF/High Density Fiberboard (untuk tipe+) atau lapisan dasar HMR (untuk tipe **Non+**). Rangka keliling menggunakan kayu engineered yang lebih stabil dibandingkan kayu solid (tidak mudah memuai maupun menyusut). Core menggunakan honeycomb untuk insulasi suara dan temperatur. Sisi tebal pintu/lipping sudah finishing sesuai warna motif.

SPEKIFIKASI

Lebar	720/ 820/ 920 mm
Tinggi	2100/ 2400 mm
Tebal	36 mm
Berat	25 Kg

Laminasi terdiri dari 3 macam :

- Romeo (HPL/ High Pressure Laminate)
- Vegan Wood (Engineered Wood Veneer)
- Giulia (PVC Laminate)

Keunggulan pintu Laminasi :

- Tersedia 100+ pilihan motif untuk memenuhi desain ruangan atau rumah
- Praktis, mudah pemasangannya lebih ringan

ANGZLAMINO SILENT SPEC COMPARISON

ANGZ	ROMEO H	ROMEO H	ROMEO M	GIULIA H	GIULIA H	GIULIA M	VEGAN M
	SILENT+	SILENT	SILENT	SILENT+	SILENT	SILENT	SILENT+
FACE	HDF	HDF	HMR	HDF	HDF	HMR	HMR
LAMINATE	HPL	HPL	HPL	PVC	PVC	PVC	VEGAN
CORE	HONEYCOMB	POLYSTYRENE	POLYSTYRENE	HONEYCOMB	POLYSTYRENE	POLYSTYRENE	HONEYCOMB

GROOVE STYLE

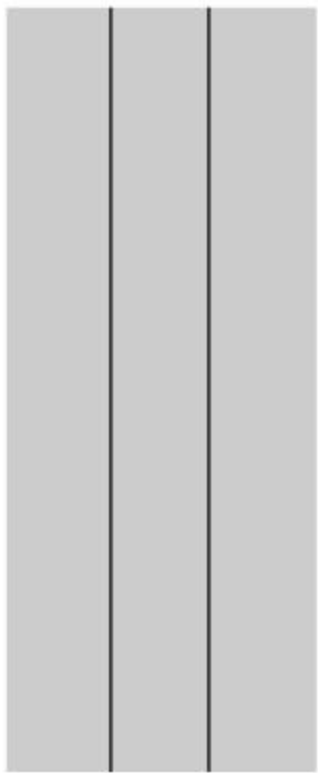

C

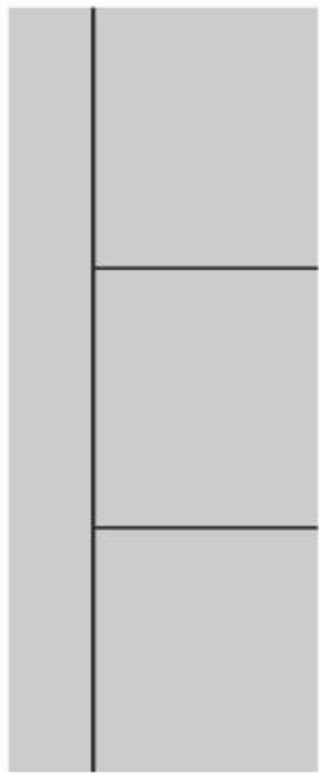

D

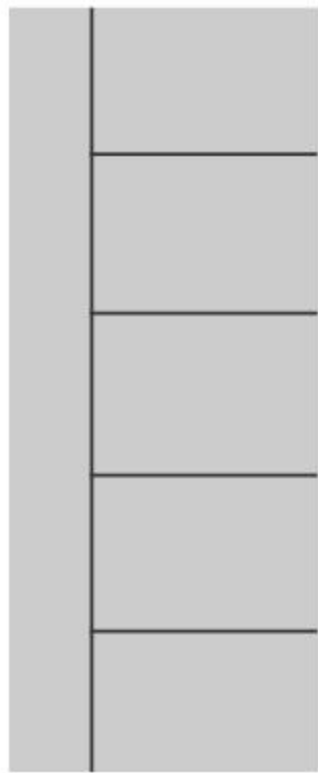

E

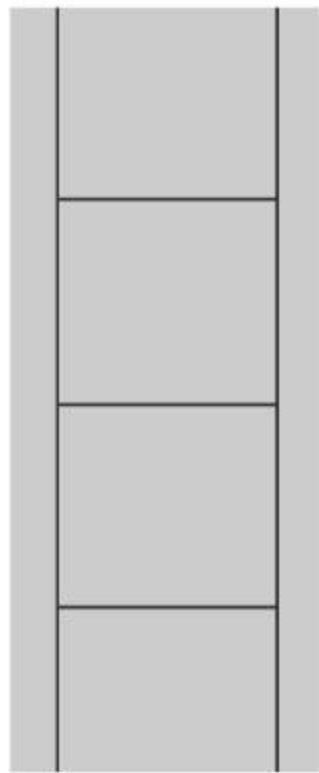

F



G

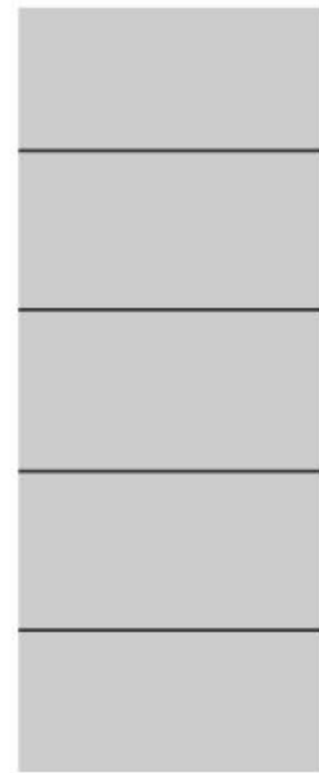

H

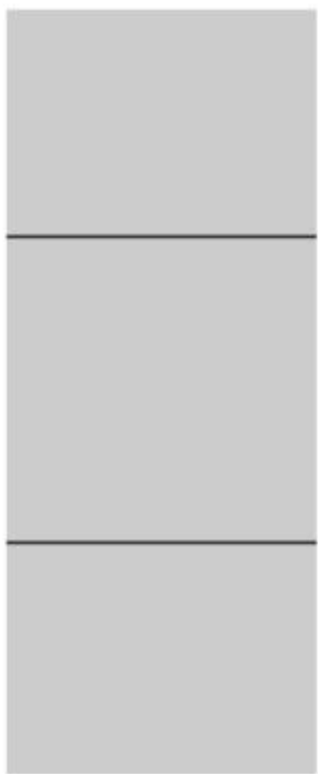

I

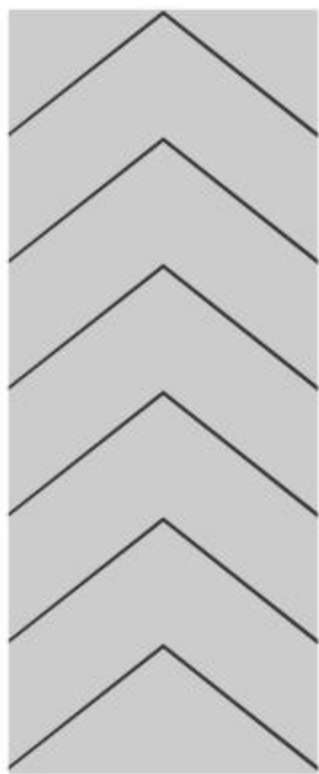

K

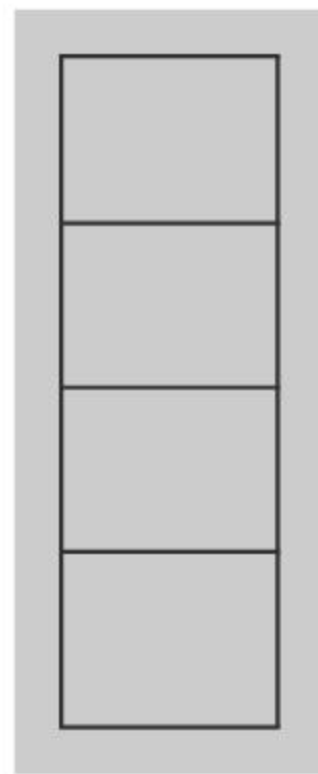

L

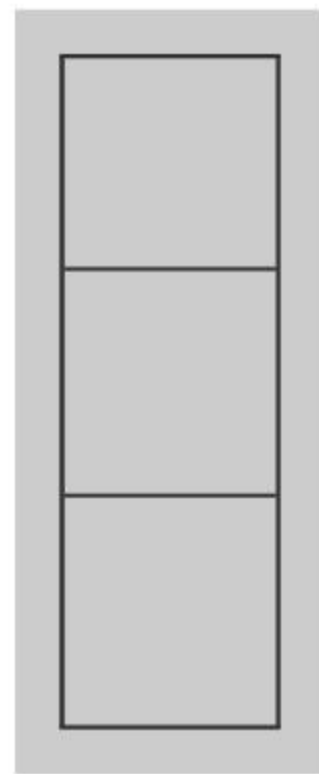

M

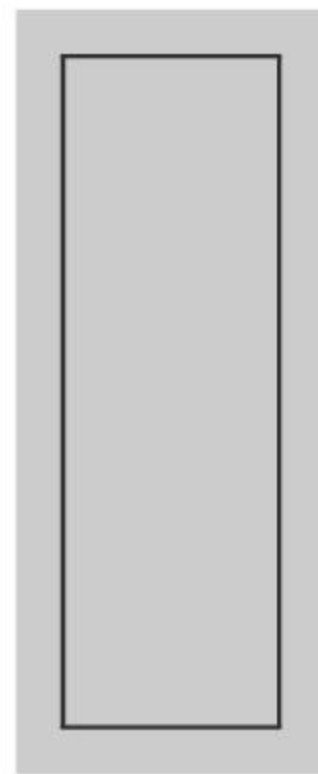

N

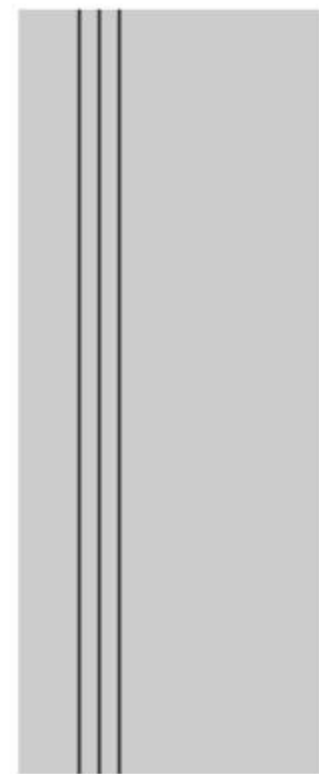

O

Romeo+ / Romeo

PREMIUM HPL DARK TONE WOODGRAIN



L2 TH 03 KM



L2 TH 18 RE



L2 TH 20 RE



L2 TH 152 AA



L2 TH 179 AA



L2 TH 317 H



L2 TH 325 H



L2 TH 356 H



L2 TH 818 J



L2 TH 846 J



L2 TH 865 JG



L2 TH 876 RE



L2 TH 920 J



L2 TH 1034 B



L2 TH 1206 FC



L2 TH 1207 FC



L2 TH 1217 FC

Romeo+ / Romeo

PREMIUM HPL MEDIUM TONE WOODGRAIN



L2 TH 15 RE



L2 TH 17 RE



L2 TH 120 AA



L2 TH 171 GL



L2 TH 357 H



L2 TH 361 H



L2 TH 802 J



L2 TH 878 J



L2 TH 884 RE



L2 TH 171 GL



L2 TH 890 FC



L2 TH 993 J



L2 TH 1200 FC



L2 TH 1205 FC



L2 TH 1216 FC



L2 TH 1222 FC



L2 TH 1225 FC

Romeo+ / Romeo

PREMIUM HPL LIGHT TONE WOODGRAIN



Romeo
L2 TH 882 RE



L2 TH 167 AA



L2 TH 363 H



L2 TH 817 J



L2 TH 881 J



L2 TH 882 RE



L2 TH 1038 B



L2 TH 849 J



L2 TH 862 J



L2 TH 872 RE



L2 TH 19 RE



L2 TH 100 AA



L2 TH 103 AA



L2 TH 1215 FC



L2 TH 1224 FC

Romeo+

HPL WOODGRAIN



L1 R1



L1 R2



L1 R3



L1 R4



L1 R5



L1 R6



L1 R7

Romeo+ / Romeo

HPL WOODGRAIN



L3 P061 Frost Teak



L3 P055 Avoli Oak



L3 P043 Niseko Oak



L3 P089 Snow Walnut



L3 P065 Milk Sedal



L3 P057RL Noble Fir
Real Lumber



L3 002 White Larch



L3 001 Snow Maple



L3 072 Ash Cocoa



L3 007 Laurel Oak



L3 010 Canyon Oak



L3 P069 White Bamboo

Romeo+ / Romeo

HPL WOODGRAIN



L3 P096 Ash Cocoa



L3 009 Turkey Oak



L3 P063 Sugar Maple



L3 P058 Fraser Fir



L3 P068 Natural Pine



L3 P092 Straight Rhumba



L3 P066 Tea Sedal



L3 P046 Sienna Katsura



L3 090 Harmony Teak



L3 P060 Toast Teak



L3 014 Cocoa Deluxe



L3 017 Coffee Deluxe



L3 022 Picollo



L3 P047 Raven Katsura



L3 011 Brown Beech



L3 P051 Gold Sycamore



L3 020 Stella Cherry



L3 016 Straight Teak



L3 021 Colombia Cherry



L3 024 African Sapele



L3 P064 Red Moka



L3 030 Red Rosewood



L3 P071 Red Teak



L3 031 Sepia Walnut



L3 026 Topaz Walnut



L3 P059 Balsam Fir



L3 029 Malay Oak



L3 032 Afrikan Wenge



L3 P084 Mocca Firwood



L3 019 Ashed Oak

Romeo+ / Romeo

HPL WOODGRAIN



L3 P070 Sandy Lines



L3 P087 Country Oak



L3 P049 Amber Walnut



L3 023 Choco Walnut



L3 027 Russet Teak



L3 077 Light Zebra



L3 P095 Espresso Nova



L3 033 Palmtree



L3 076 Dark ZebranWood



L3 036 Golden Palm



L3 034 Cozina



L3 035 Hazy Elm



L3 086 Gray Finelines



L3 018 Liverpool Wood



L3 P067 Coffee Sedal



L3 078 Ash Picollo



L3 079 Quaterline Ash



L3 P054 Milano Pear



L3 P048 Snow
Katsura



L3 P062 Quit Maple



L3 P056 Caen Oak



L3 P045 Yezo Elm



L3 P042 Hokkaido
Oak



L3 P050 Dove Walnut

Romeo+ / Romeo

HPL PATTERN



L3 080 Steel Charm



L3 038G Noir Marble
Glossy



L3 2000 Silver Hairline

Giulia+ / Giulia

Laminate Door



Giulia+

PVC WOODGRAIN



C1 G1



C1 G2



C1 G3



C1 G4



C1 G5



C1 G6



C1 G7

Giulia +/ Giulia

PVC WOODGRAIN



C2 1099



C2 4288



C2 8050-3R



C2 A 1337



C2 B 411



C2 B 593



C2 F 605



C2 G 021



C2 H 109



C2 H 1034

Giulia +/ Giulia

PVC SOLID



C2 8457 R



C2 P 02 G



C2 P 03 G



C2 P 10



C2 P 15

Vegan Wood

Engineered Wood Veneer Laminate Door



Vegan Wood

ENGINEERED WOOD VENEER



V2 R2 F1 EGGER OAK



V2 R2 F2 WHITE AMERICAN WALNUT



V2 R2 F3 BROWN AMERICAN WALNUT



V2 R2 F4 GALITE OAK



V2 R2 F5 TAWNY MAHOGANY



V2 R2 F6 NATURAL LARCH



V2 R2 F7 ROSETTE FILEMOT



V2 R2 F8 CHENGAI OAK



V2 R2 F9 DARK LARCH



V2 R2 F10 OAK CANTRABIA

Vegan Wood

ENGINEERED WOOD VENEER



V2 V14



V2 V17



V2 V18



V2 V19



V2 V20



V2 V9

EXTERIOR DOOR & WINDOWS SERIES



HOFFEN uPVC Door and Windows

Adalah pintu dan jendela exterior bahan uPVC dengan teknologi german sehingga memiliki banyak kelebihan dibandingkan dengan bahan aluminium dengan garansi warna hingga 10 th berikut beberapa kelebihan jendela upvc :

- uPVC menggunakan profil yang memungkinkan perpindahan panas yang terkontrol.
- uPVC tidak mudah menghantarkan panas.
- uPVC juga menjadikan ruangan lebih kedap terhadap suara.

- Profil kusen digabungkan dengan EPDM sealed rubber menutup semua celah untuk air hujan dari luar.
- Bahan material uPVC bukan merupakan penghantar api dan panas.
- Material uPVC memiliki ketahanan yang sangat tinggi.
- Material uPVC juga tidak perlu dicat atau difinishing ulang.
- Profil uPVC 100% merupakan bahan ramah lingkungan.
- Memiliki sistem penguncian yang sangat tinggi, sehingga aman.
- Material uPVC dapat bertahan hingga 50 tahun.
- Warna material uPVC mampu bertahan hingga 10 tahun tanpa menguning.
- Komplit set sudah termasuk kaca, handle dan accessories.

SPEKIFIKASI

Warna

White

Garansi

10 Tahun

Sliding Window + Mosquito net



Uk. 1200x1100mm
Uk. 1500x1100mm

Casement



Uk. 600x1100mm

Sliding Door + Mosquito net



Uk. 1600x2050mm
Uk. 2000x2050mm

Sliding Window



Uk. 1800x1100mm

Casement Top Hung



Uk. 800x500mm

Sliding Window



Uk. 800x500mm

Sliding Window



Uk. 2400x1100mm



angzcommetz

HUBUNGI



JL.RAYA JANTI NO.96

YOGYAKARTA

(0274) 493 22 88

08112863773

(CHAT ONLY)

f qhomemart t qhomemart

@ qhomemart v qhomemart

WWW.QHOMEMART.COM