



TEKIRO®

CATALOG 2021

BRAND CONCEPT

TEKIRO is a trusted brand for hand tools products. Having quality and safety in mind to meet the high expectations of professional users, materials were carefully chosen, designed ergonomically and manufactured to international standards such as JIS, ASME and DIN.

TEKIRO offers a wide range of hand tools covering categories such as screwdrivers, air tools and automotive, ideal for technicians, electricians, mechanics, repairmen, plumbers and etc. From a humble beginning starting with automotive and industrial tools, the brand has grown and expanded into automotive equipment, diagnostic tools, nitrogen generator and welding machines. We will continue to expand our product range to provide the right tools for the right job.

TEKIRO prides itself in providing professional tradesmen with international quality tools at affordable prices. Having its own manufacturing facilities and 150 global manufacturing partners, Tekiro is able to provide the best quality tools and value to end users.

BELIEVE IN YOUR CHOICE

WRENCH	5-32
TORQUE	33-38
SOCKET	39-70
IMPACT SOCKET	71-78
PLIER	79-98
SCREWDRIVER	99-116
AUTOMOTIVE	117-168
STORAGE	169-184
TRAY	185-196
AIR TOOLS	197-228
HEX KEY	229-238
GENERAL TOOLS	239-274
SPECIAL TOOLS	275-280
INSULATION	281-290
WELDING	291-296
GARDENING	297-300
MEASUREMENT	301-305

TABLE OF CONTENTS



WRENCH

TEKIRO Wrenches are manufactured exceeding JIS standards. All are forged from chrome vanadium steel, precision machined, heat treated to exacting standards. They fulfil the needs of the professional engineer.

- Drop forged to ensure uniform grain structure, giving increased strength and reliability.
- Heat treated in carefully controlled conditions to ensure optimum performance for every wrench.
- Chrome nickel silver plated for maximum corrosion protection.

TEKIRO advanced ring configuration increases the contact area between the wrench and fastener, minimizing stress and reducing the chance of fastener damage.

COMBINATION WRENCHES

TEKIRO combination wrenches feature Stress Relief Drive on the ring end. All open jaw ends feature a constant radius of curvature reducing stress concentrations and jaw flexing. Both of these features enhance fastener grip and prolong both tool and fastener life. All Tekiro combination wrenches exceed JIS Standards.

TEKIRO combination wrenches are supplied in 2 different size variants : metric and inch.

TEKIRO combination wrenches are clearly marked with the wrench size on the open jaw head for ease of identification.

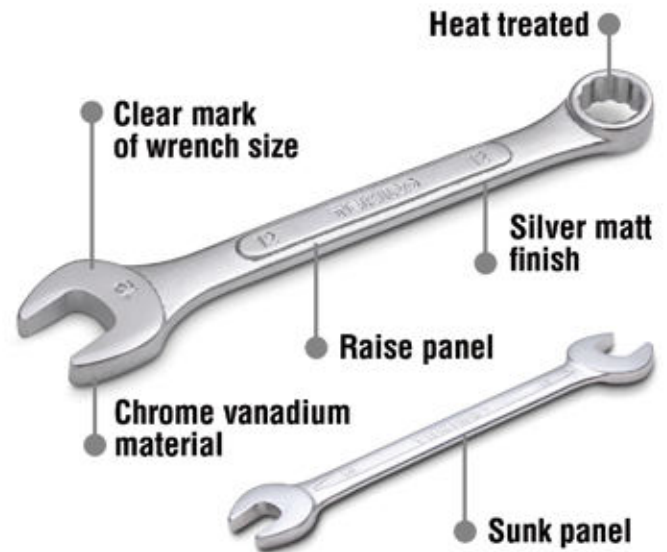

OPEN END WRENCHES

TEKIRO open jaw ends feature a constant radius of curvature - reducing stress concentrations and jaw flexing.



BOX END WRENCHES

TEKIRO ring wrench are offset at 45° for ease of access and feature stress relief drive.



SAFETY INSTRUCTION

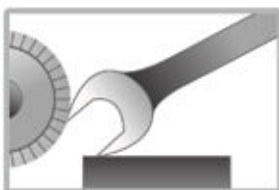

DO NOT grind or alter the shape of the wrench



DO NOT strike the wrench unless it is designed for this purpose



Always ensure there is a positive fit onto the fastener



DO NOT extend length of wrench by locking together or extension bar



WRENCH

TORQUE

SOCKET

IMPACT SOCKET

PLIER

SCREWDRIVER

- Chrome vanadium steel
- Dropped forged and heat treated for extra strength
- Silver Matt finish
- Raised Panel type provides added strength

COMBINATION WRENCH

KUNCI RING PAS

METRIC

ITEM CODE	SIZE	1 (mm)	2 (mm)	3 (mm)	4 (mm)	5 (mm)	6 (mm)	7 (mm)	WEIGHT (gr)	QTY / BOX
WR-C00001	6 mm	93	10	6	3	4	13	6	23	12 / 480 pcs
WR-C00002	7 mm	98	11	7	3	4	16	7	26	12 / 480 pcs
WR-C00003	8 mm	102	14	8	6	6	19	8	30	12 / 240 pcs
WR-C00004	9 mm	116	14	9	4	6	20	9	40	12 / 240 pcs
WR-C00005	10 mm	122	17	10	6	8	23	10	47	12 / 240 pcs
WR-C00006	11 mm	131	17	11	6	7	25	11	54	12 / 240 pcs
WR-C00007	12 mm	142	18	10	6	7	25	12	59	12 / 240 pcs
WR-C00008	13 mm	148	19	13	5	7	26	13	77	12 / 144 pcs
WR-C00009	14 mm	168	22	14	7	8	30	14	101	12 / 144 pcs
WR-C00010	15 mm	189	24	15	7	9	32	15	119	12 / 144 pcs
WR-C00011	16 mm	189	25	13	7	10	35	16	125	12 / 144 pcs
WR-C00012	17 mm	207	26	14	7	10	36	17	157	12 / 72 pcs
WR-C00013	18 mm	207	27	18	8	10	37	18	155	12 / 72 pcs
WR-C00014	19 mm	230	29	19	8	10	39	19	186	12 / 72 pcs
WR-C00015	20 mm	262	31	20	7	10	43	20	251	12 / 72 pcs
WR-C00016	21 mm	255	31	21	10	12	43	21	223	6 / 72 pcs
WR-C00017	22 mm	279	34	22	9	11	45	22	320	6 / 36 pcs
WR-C00018	23 mm	280	34	17	10	12	44	23	325	6 / 36 pcs
WR-C00019	24 mm	304	35	24	10	12	49	24	432	6 / 36 pcs
WR-C00020	25 mm	329	38	25	10	12	51	25	480	6 / 24 pcs
WR-C00021	26 mm	325	38	26	11	12	51	26	530	6 / 24 pcs
WR-C00022	27 mm	346	42	27	11	13	57	27	580	6 / 24 pcs
WR-C00023	28 mm	358	42	28	11	13	57	28	584	6 / 24 pcs
WR-C00024	29 mm	380	43	28	11	13	57	29	642	6 / 24 pcs
WR-C00025	30 mm	380	43	30	11	13	60	30	680	6 / 24 pcs
WR-C00026	32 mm	429	48	27	14	18	65	32	884	6 / 24 pcs
WR-C00027	33 mm	435	50	33	15	18	66	33	1,130	5 / 20 pcs
WR-C00028	34 mm	430	50	26	14	18	66	34	1,170	5 / 20 pcs
WR-C00029	35 mm	434	51	35	16	20	67	35	1,220	5 / 20 pcs
WR-C00030	36 mm	489	54	36	16	21	74	36	1,480	5 / 20 pcs
WR-C00031	38 mm	518	55	38	16	21	83	38	1,760	5 / 20 pcs
WR-C00032	41 mm	545	64	41	17	23	92	41	2,180	5 / 10 pcs
WR-C00033	42 mm	543	65	33	16	22	91	42	2,320	5 / 10 pcs
WR-C00034	46 mm	545	65	46	17	22	90	46	2,041	5 / 10 pcs
WR-C00035	50 mm	610	72	50	20	24	95	50	2,680	5 / 10 pcs
WR-C00036	55 mm	630	90	55	20	30	12	55	3,040	1 / 5 pcs
WR-C00037	60 mm	630	90	60	19	29	13	60	3,490	1 / 5 pcs

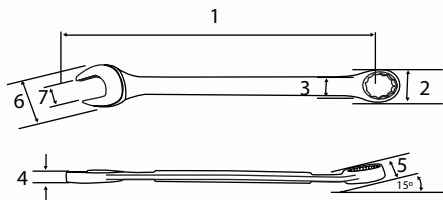

INCH

ITEM CODE	SIZE	1 (mm)	2 (mm)	3 (mm)	4 (mm)	5 (mm)	6 (mm)	WEIGHT (gr)	QTY / BOX
WR-C00038	5 / 16"	102	19	13	5	6	8	31	12 / 240 pcs
WR-C00039	3 / 8"	116	21	15	5	6	10	40	12 / 240 pcs
WR-C00040	7 / 16"	131	25	17	6	7	25	54	12 / 240 pcs
WR-C00041	1 / 2"	148	28	20	6	8	13	84	12 / 144 pcs
WR-C00042	9 / 16"	168	30	22	7	8	15	98	12 / 144 pcs
WR-C00043	5 / 8"	189	32	24	7	9	16	118	12 / 144 pcs
WR-C00044	11 / 16"	207	37	27	8	10	18	169	12 / 72 pcs
WR-C00045	3 / 4"	230	40	29	8	11	19	200	12 / 72 pcs
WR-C00046	13 / 16"	260	43	32	9	12	43	257	6 / 36 pcs
WR-C00047	7 / 8"	280	44	34	10	12	23	292	6 / 36 pcs
WR-C00048	15 / 16"	310	49	36	11	12	25	354	6 / 36 pcs
WR-C00049	1"	333	51	38	11	13	26	462	6 / 24 pcs
WR-C00050	1-1 / 16"	361	57	42	11	13	27	610	6 / 24 pcs
WR-C00051	1-1 / 8"	382	60	44	12	14	60	663	6 / 24 pcs
WR-C00052	1-1 / 4"	412	64	48	12	15	64	868	6 / 24 pcs

BOX END WRENCH

KUNCI RING

- Chrome vanadium steel
- Dropped forged and heat treated for extra strength
- Silver Matt finish
- Raised Panel type provides added strength

ITEM CODE	SIZE	1 (mm)	2 (mm)	3 (mm)	4 (mm)	5 (mm)	6 (mm)	7 (mm)	WEIGHT (gr)	QTY / BOX INNER/MASTER
WR-BE0053	6 X 7 mm	163	11	12	6	6	6	7	50	12 / 360 pcs
WR-BE0054	8 X 9 mm	174	14	15	6	6	8	9	63	12 / 360 pcs
WR-BE0055	8 X 10 mm	174	14	15	6	7	8	10	71	12 / 360 pcs
WR-BE0056	10 X 11 mm	186	16	18	6	7	10	11	81	12 / 360 pcs
WR-BE0057	10 X 12 mm	187	16	19	7	7	10	12	80	12 / 360 pcs
WR-BE0058	12 X 13 mm	216	19	22	7	8	12	13	132	12 / 192 pcs
WR-BE0059	12 X 14 mm	211	19	22	7	8	12	14	168	12 / 192 pcs
WR-BE0060	14 X 15 mm	246	24	27	9	9	14	15	197	12 / 120 pcs
WR-BE0061	14 X 17 mm	245	24	27	11	11	14	17	197	12 / 120 pcs
WR-BE0062	16 X 17 mm	244	24	27	10	10	16	17	193	12 / 120 pcs
WR-BE0063	17 X 19 mm	289	29	31	11	11	17	19	253	6 / 96 pcs
WR-BE0064	18 X 19 mm	289	29	33	11	11	18	19	272	6 / 96 pcs
WR-BE0065	19 X 21 mm	295	29	33	11	11	19	21	290	6 / 60 pcs
WR-BE0066	20 X 22 mm	296	31	34	11	11	20	22	289	6 / 60 pcs
WR-BE0067	21 X 23 mm	312	33	36	11	11	21	23	369	6 / 60 pcs
WR-BE0068	22 X 24 mm	319	33	36	11	12	22	24	373	6 / 60 pcs
WR-BE0069	24 X 27 mm	368	37	38	13	12	24	27	575	6 / 36 pcs
WR-BE0070	25 X 28 mm	375	39	46	14	15	25	28	744	6 / 36 pcs
WR-BE0071	30 X 32 mm	405	47	48	15	15	30	32	833	6 / 36 pcs

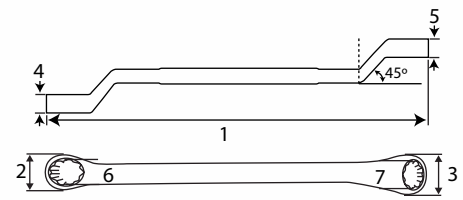

OPEN END WRENCH

KUNCI PAS

- Chrome vanadium steel
- Dropped forged and heat treated for extra strength
- Silver Matt finish
- Raised Panel type provides added strength

ITEM CODE	SIZE	1 (mm)	2 (mm)	3 (mm)	4 (mm)	5 (mm)	6 (mm)	7 (mm)	WEIGHT (gr)	QTY / BOX INNER/MASTER
WR-OE0072	6 X 7 mm	96	15	16	5	5	6	7	28	12 / 480 pcs
WR-OE1649	6 X 8 mm	96	15	15	4	4	6	8	33	12 / 480 pcs
WR-OE0073	8 X 9 mm	110	18	19	5	5	8	9	38	12 / 480 pcs
WR-OE0074	8 X 10 mm	110	18	20	5	4	8	10	35	12 / 480 pcs
WR-OE0075	10 X 11 mm	126	22	26	6	6	10	11	56	12 / 480 pcs
WR-OE0076	10 X 12 mm	126	21	25	4	4	10	12	58	12 / 480 pcs
WR-OE0077	12 X 13 mm	140	27	29	6	6	12	13	78	12 / 192 pcs
WR-OE0078	12 X 14 mm	141	27	29	6	6	12	14	79	12 / 192 pcs
WR-OE0079	14 X 15 mm	157	30	34	7	7	14	15	102	12 / 192 pcs
WR-OE0080	14 X 17 mm	160	30	34	7	7	14	17	103	12 / 192 pcs
WR-OE0081	16 X 17 mm	172	33	36	7	7	16	17	130	12 / 192 pcs
WR-OE0082	17 X 19 mm	188	37	39	7	7	17	19	180	6 / 96 pcs
WR-OE0083	18 X 19 mm	188	37	39	7	7	18	19	176	12 / 96 pcs
WR-OE0084	19 X 21 mm	212	41	46	8	8	19	21	276	6 / 96 pcs
WR-OE0085	20 X 22 mm	210	46	41	9	9	20	22	273	12 / 72 pcs
WR-OE0086	21 X 23 mm	210	46	46	10	10	21	23	260	6 / 96 pcs
WR-OE0087	22 X 24 mm	211	41	46	10	10	22	24	243	6 / 72 pcs
WR-OE0088	24 X 27 mm	254	50	50	10	10	24	27	356	6 / 72 pcs
WR-OE0089	25 X 28 mm	270	54	64	10	10	25	28	497	6 / 36 pcs
WR-OE0090	30 X 32 mm	293	58	64	12	12	30	32	688	6 / 36 pcs

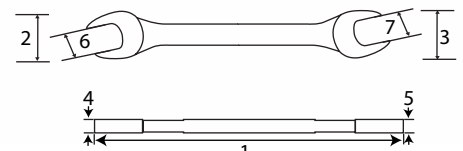

WRENCH

TORQUE

SOCKET

IMPACT SOCKET

PLIER

SCREWDRIVER

- Chrome vanadium steel
- Dropped forged and heat treated for extra strength
- Silver Matt finish
- German Type (DIN 899)
- Sunk panel for easy access to tight spaces

COMBINATION WRENCH - SUNK PANEL

KUNCI RING PAS - SUNK PANEL

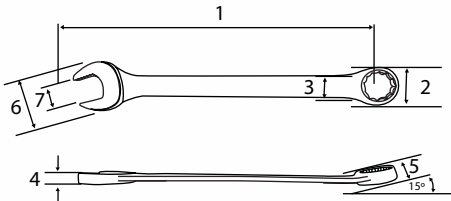

ITEM CODE	SIZE	1 (mm)	2 (mm)	3 (mm)	4 (mm)	5 (mm)	6 (mm)	7 (mm)	WEIGHT (gr)	QTY / BOX INNER/MASTER
WR-C00091	6 mm	105	10	6	3	4	14	6	21	12 / 480 pcs
WR-C00092	7 mm	116	12	7	4	5	16	7	25	12 / 480 pcs
WR-C00093	8 mm	125	13	8	3	5	18	8	25	12 / 480 pcs
WR-C00094	9 mm	135	13	9	3	5	20	9	32	12 / 240 pcs
WR-C00095	10 mm	136	14	10	3	5	21	10	31	12 / 240 pcs
WR-C00096	11 mm	155	17	11	4	7	25	11	48	12 / 240 pcs
WR-C00097	12 mm	165	19	12	5	6	26	12	62	12 / 240 pcs
WR-C00098	13 mm	175	19	13	5	7	28	13	75	12 / 144 pcs
WR-C00099	14 mm	185	22	14	5	7	30	14	83	12 / 144 pcs
WR-C00100	15 mm	196	23	15	6	8	33	15	106	12 / 144 pcs
WR-C00101	16 mm	206	24	16	6	8	33	16	116	12 / 144 pcs
WR-C00102	17 mm	216	25	17	7	9	35	17	133	12 / 144 pcs
WR-C00103	18 mm	227	27	18	7	8	38	18	160	12 / 144 pcs
WR-C00104	19 mm	234	28	19	7	10	40	19	170	12 / 120 pcs
WR-C00105	20 mm	245	29	20	7	10	43	20	196	12 / 72 pcs
WR-C00106	21 mm	256	32	21	8	10	45	21	219	6 / 72 pcs
WR-C00107	22 mm	267	33	22	8	12	46	22	230	6 / 72 pcs
WR-C00108	23 mm	273	33	23	8	12	46	23	260	6 / 72 pcs
WR-C00109	24 mm	286	35	24	8	12	48	24	298	6 / 72 pcs
WR-C00110	25 mm	295	37	25	8	11	51	25	315	6 / 36 pcs
WR-C00111	26 mm	300	38	26	9	10	52	26	348	6 / 36 pcs
WR-C00112	27 mm	310	39	27	8	11	55	27	356	6 / 48 pcs
WR-C00113	28 mm	323	41	28	10	12	56	29	429	6 / 36 pcs
WR-C00114	29 mm	331	42	29	10	13	59	29	480	6 / 36 pcs
WR-C00115	30 mm	340	44	30	10	13	61	30	499	6 / 36 pcs
WR-C00116	32 mm	360	46	32	11	13	64	32	587	6 / 36 pcs

- Chrome vanadium steel
- Dropped forged
- Silver Matt finish
- German Type (DIN 899)
- 45 Degree

BOX END WRENCH 45 DEGREE - SUNK PANEL

KUNCI RING - SUNK PANEL

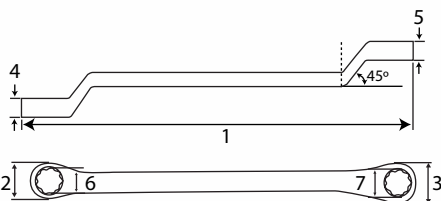

ITEM CODE	SIZE	1 (mm)	2 (mm)	3 (mm)	4 (mm)	5 (mm)	6 (mm)	7 (mm)	WEIGHT (gr)	QTY / BOX INNER/MASTER
WR-BE0117	6 X 7 mm	170	11	13	13	5	6	7	48	12 / 360 pcs
WR-BE0118	8 X 9 mm	174	14	15	15	7	8	9	60	12 / 300 pcs
WR-BE0119	8 X 10 mm	189	14	16	16	6	8	10	72	12 / 300 pcs
WR-BE0120	10 X 11 mm	200	16	18	18	7	10	11	98	12 / 240 pcs
WR-BE0121	10 X 12 mm	187	16	19	19	8	10	12	93	12 / 240 pcs
WR-BE0122	12 X 13 mm	211	19	21	21	8	12	13	107	12 / 192 pcs
WR-BE0123	12 X 14 mm	225	20	21	21	8	12	14	134	12 / 144 pcs
WR-BE0124	14 X 15 mm	237	22	23	23	8	14	15	151	12 / 120 pcs
WR-BE0125	14 X 17 mm	241	22	25	25	9	14	17	159	12 / 120 pcs
WR-BE0126	16 X 17 mm	250	25	26	26	9	16	17	178	12 / 120 pcs
WR-BE0127	17 X 19 mm	257	25	27	27	10	17	19	215	12 / 96 pcs
WR-BE0128	18 X 19 mm	259	22	28	28	11	18	20	219	6 / 96 pcs
WR-BE0129	19 X 21 mm	277	28	30	30	11	19	21	242	12 / 96 pcs
WR-BE0130	20 X 22 mm	282	29	32	32	11	20	22	260	6 / 96 pcs
WR-BE0131	21 X 23 mm	301	31	33	33	11	21	23	326	6 / 72 pcs
WR-BE0132	22 X 24 mm	333	32	34	34	11	22	24	379	6 / 60 pcs
WR-BE0133	24 X 27 mm	376	34	39	39	12	24	27	474	6 / 36 pcs
WR-BE0134	25 X 28 mm	377	35	40	40	15	25	28	524	6 / 30 pcs
WR-BE0135	30 X 32 mm	389	42	48	48	15	30	32	670	6 / 30 pcs

BOX END WRENCH 75 DEGREE - SUNK PANEL

KUNCI RING 75° - SUNK PANEL

- Chrome vanadium steel
- Dropped forged
- Silver Matt finish
- German Type (DIN 899)

ITEM CODE	SIZE	1 (mm)	2 (mm)	3 (mm)	4 (mm)	5 (mm)	6 (mm)	7 (mm)	WEIGHT (gr)	QTY / BOX INNER/MASTER
WR-BE0136	6 X 7 mm	174	12	13	5	5	6	7	59	12 / 240 pcs
WR-BE0137	8 X 9 mm	178	13	15	6	6	8	9	54	12 / 240 pcs
WR-BE0138	8 X 10 mm	191	13	15	6	6	8	10	77	12 / 240 pcs
WR-BE0139	10 X 11 mm	207	16	17	6	7	10	11	108	12 / 144 pcs
WR-BE0140	10 X 12 mm	208	16	18	7	7	10	12	111	12 / 144 pcs
WR-BE0141	12 X 13 mm	210	19	21	6	7	12	13	103	12 / 96 pcs
WR-BE0142	12 X 14 mm	226	19	21	7	7	12	14	142	12 / 96 pcs
WR-BE0143	14 X 15 mm	247	21	23	8	9	14	15	175	12 / 96 pcs
WR-BE0144	14 X 17 mm	251	21	26	8	9	14	17	214	12 / 72 pcs
WR-BE0145	16 X 17 mm	245	25	26	9	10	16	17	176	12 / 72 pcs
WR-BE0146	17 X 19 mm	257	25	27	10	10	17	19	215	6 / 48 pcs
WR-BE0147	18 X 19 mm	303	28	29	10	10	18	19	263	6 / 48 pcs
WR-BE0148	19 X 21 mm	275	29	33	12	12	19	21	266	6 / 48 pcs
WR-BE0149	20 X 22 mm	326	31	33	10	11	20	22	355	6 / 48 pcs
WR-BE0150	21 X 23 mm	340	31	35	12	12	21	23	401	6 / 36 pcs
WR-BE0151	22 X 24 mm	325	33	35	11	12	22	24	374	6 / 36 pcs
WR-BE0152	24 X 27 mm	365	36	39	12	13	24	27	462	6 / 36 pcs
WR-BE0153	25 X 28 mm	368	36	40	13	15	25	28	532	6 / 36 pcs
WR-BE0154	30 X 32 mm	380	40	46	15	16	30	32	652	6 / 24 pcs

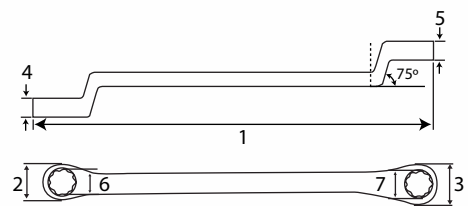

OPEN END WRENCH - SUNK PANEL

KUNCI PAS - SUNK PANEL

- Chrome vanadium steel
- Dropped forged
- Chrome Nickel Silver Matt finish
- German Type (DIN 899)
- Ends are slanted 15 degree for quick access

ITEM CODE	SIZE	1 (mm)	2 (mm)	3 (mm)	4 (mm)	5 (mm)	6 (mm)	7 (mm)	WEIGHT (gr)	QTY / BOX INNER/MASTER
WR-OE0155	6 X 7 mm	122	16	19	4	4	6	7	29	12 / 360 pcs
WR-OE0156	8 X 9 mm	110	18	19	4	4	8	9	41	12 / 360 pcs
WR-OE0157	8 X 10 mm	140	20	23	4	4	8	10	41	12 / 360 pcs
WR-OE0158	10 X 11 mm	155	26	28	5	5	10	11	66	12 / 360 pcs
WR-OE0159	10 X 12 mm	157	25	28	5	5	10	12	68	12 / 360 pcs
WR-OE0160	12 X 13 mm	163	29	31	6	6	12	13	88	12 / 240 pcs
WR-OE0161	12 X 14 mm	181	31	33	6	6	12	14	102	12 / 144 pcs
WR-OE0162	14 X 15 mm	190	33	34	6	6	14	15	111	12 / 144 pcs
WR-OE0163	14 X 17 mm	155	33	34	6	6	14	17	168	12 / 144 pcs
WR-OE0164	16 X 17 mm	204	37	38	7	7	16	17	133	12 / 144 pcs
WR-OE0165	17 X 19 mm	188	37	39	7	7	17	19	224	12 / 96 pcs
WR-OE0166	18 X 19 mm	188	37	39	7	7	18	19	173	12 / 96 pcs
WR-OE0167	19 X 21 mm	233	43	47	7	7	19	21	221	12 / 96 pcs
WR-OE0168	20 X 22 mm	234	44	47	8	8	20	22	221	12 / 96 pcs
WR-OE0169	21 X 23 mm	210	41	46	8	8	21	23	248	12 / 72 pcs
WR-OE0170	22 X 24 mm	247	46	50	8	8	22	24	244	12 / 72 pcs
WR-OE0171	24 X 27 mm	254	48	50	9	9	24	27	473	6 / 60 pcs
WR-OE0172	25 X 28 mm	276	55	61	10	10	25	28	389	6 / 60 pcs
WR-OE0173	30 X 32 mm	293	58	64	10	10	30	32	668	6 / 36 pcs
SA-OE1467	36 X 41 mm	307	90	74	13	13	41	36	1,092	5 / 20 pcs

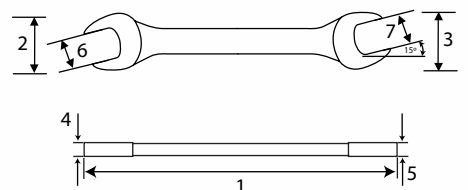

WRENCH

TORQUE

SOCKET

IMPACT SOCKET

PLIER

SCREWDRIVER

STUBBY GEAR WRENCHES

Ratcheting at 5 degree arc made possible with 72 Gear teeth metal construction.

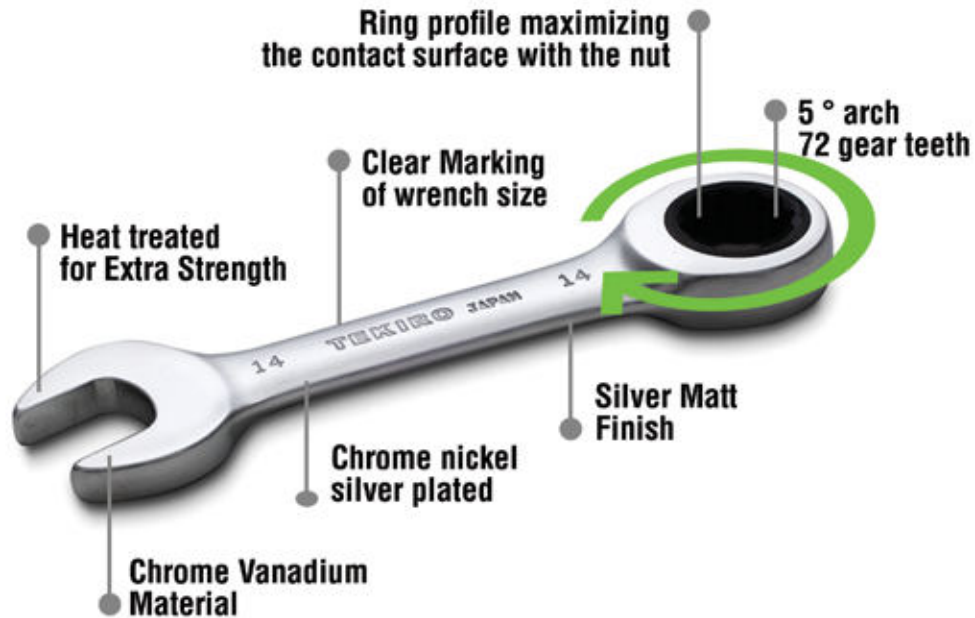

FLEXIBLE GEAR WRENCHES

Ratcheting at 5 degree arc made possible with 72 Gear teeth metal construction and Flexible Head tilts up to 90 degrees, enables greater access where standard wrench could not reach.

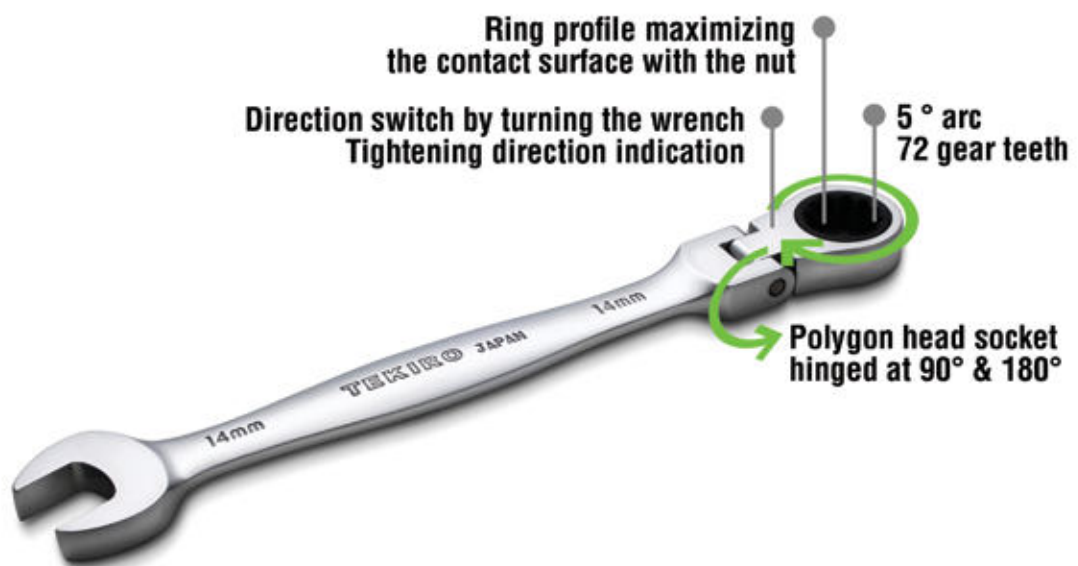



STUBBY GEAR WRENCH

KUNCI RING PAS RATCHET PENDEK

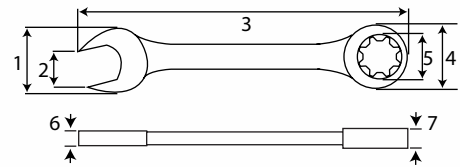

ITEM CODE	SIZE	1 (mm)	2 (mm)	3 (mm)	4 (mm)	5 (mm)	6 (mm)	7 (mm)	WEIGHT (gr)	QTY / BOX INNER/MASTER
WR-SG0174	8 mm	23	11	104	21	8	4	7	60	12 / 288 pcs
WR-SG0175	10 mm	20	10	97	20	10	5	8	51	12 / 288 pcs
WR-SG0176	11 mm	23	11	104	22	11	5	8	58	12 / 216 pcs
WR-SG0177	12 mm	24	12	104	22	12	6	9	66	12 / 216 pcs
WR-SG0178	13 mm	27	13	108	25	13	6	9	76	12 / 144 pcs
WR-SG0179	14 mm	29	14	117	28	10	6	9	93	12 / 144 pcs
WR-SG0180	17 mm	35	17	127	32	17	7	9	136	12 / 96 pcs
WR-SG0181	19 mm	29	19	139	36	19	7	12	177	12 / 72 pcs

- Chrome vanadium steel
- Drop Forged for extra strength
- Flat Panel type with Silver Matt Finish
- Ratcheting at 5 degree arc made possible with 72 Gear teeth metal construction.



SINGLE GEAR WRENCH

KUNCI RING PAS RATCHET PANJANG

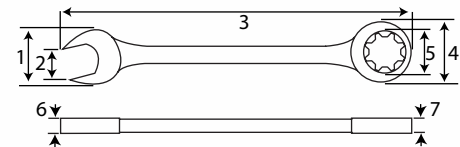

ITEM CODE	SIZE	1 (mm)	2 (mm)	3 (mm)	4 (mm)	5 (mm)	6 (mm)	7 (mm)	WEIGHT (gr)	QTY / BOX INNER/MASTER
WR-SG0182	8 mm	16	8	139	16	8	5	6	48	12 / 216 pcs
WR-SG0183	10 mm	20	10	159	20	10	6	8	66	12 / 216 pcs
WR-SG0184	11 mm	22	11	165	20	11	6	7	99	12 / 216 pcs
WR-SG0185	12 mm	24	12	171	22	12	6	7	86	12 / 144 pcs
WR-SG0186	13 mm	26	13	177	24	13	6	7	100	12 / 144 pcs
WR-SG0187	14 mm	28	14	190	253	14	7	7	154	12 / 144 pcs
WR-SG0188	17 mm	35	17	225	32	17	7	11	185	12 / 72 pcs
WR-SG0189	19 mm	39	19	247	32	192	8	12	318	12 / 72 pcs

- Chrome vanadium steel
- Drop forged for extra strength
- Flat Panel type with Silver Matt Finish
- Ratcheting at 5 Degree arc made possible with 72 Gear teeth metal construction.

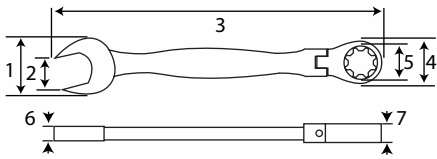

FLEXIBLE GEAR WRENCH

KUNCI RING PAS RATCHET FLEXIBLE

- Chrome vanadium steel
- With heat treatment for extra durability and strength
- Flat Panel type with Silver Matt Finish
- Ratcheting at 5 degree arc made possible with 72 Gear teeth metal construction
- Flex Head tilts up to 90 degrees, enables greater access where standard wrench could not reach

ITEM CODE	SIZE	1 (mm)	2 (mm)	3 (mm)	4 (mm)	5 (mm)	6 (mm)	7 (mm)	WEIGHT (gr)	QTY / BOX INNER/MASTER
WR-FG0190	8 mm	16	8	140	15	8	4	7	59	12 / 216 pcs
WR-FG0191	10 mm	20	10	158	17	10	6	8	88	12 / 216 pcs
WR-FG0192	11 mm	22	11	165	20	11	6	8	97	12 / 216 pcs
WR-FG0193	12 mm	24	12	171	22	12	6	9	154	12 / 144 pcs
WR-FG0194	13 mm	26	13	176	23	13	6	9	179	12 / 144 pcs
WR-FG0195	14 mm	29	15	192	25	14	7	9	204	12 / 144 pcs
WR-FG0196	17 mm	35	17	223	28	17	8	11	239	12 / 72 pcs
WR-FG0197	19 mm	40	19	245	31	19	9	12	315	12 / 72 pcs

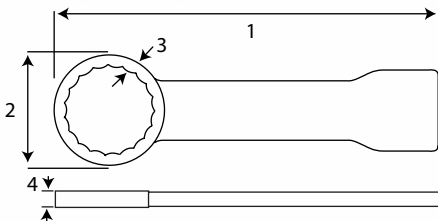

BOX IMPACT WRENCH

KUNCI RING IMPACT

- Material is Chrome Molybdenum
- Flat Striking face allow hammer blow
- DIN 899

ITEM CODE	SIZE	1 (mm)	2 (mm)	3 (mm)	4 (mm)	WEIGHT (gr)	QTY / BOX INNER/MASTER
WR-SL0198	27 mm	180	46	16	16	297	10 / 60 pcs
WR-SL0199	30 mm	190	52	17	17	398	10 / 60 pcs
WR-SL0200	32 mm	190	54	17	17	456	10 / 40 pcs
WR-SL0201	36 mm	205	59	19	20	508	10 / 30 pcs
WR-SL0202	41 mm	230	65	20	21	820	10 / 30 pcs
WR-SL0203	46 mm	240	74	22	23	1,051	5 / 20 pcs
WR-SL0204	50 mm	253	79	24	25	1,130	5 / 20 pcs
WR-SL0205	55 mm	266	85	25	25	1,260	5 / 10 pcs
WR-SL0206	60 mm	280	92	26	25	1,376	5 / 10 pcs



STAR WRENCH
KUNCI RING BINTANG

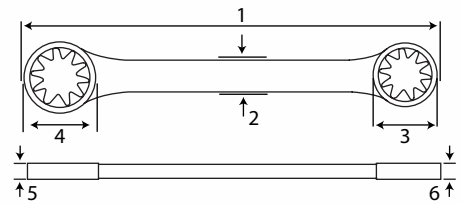

ITEM CODE	SIZE	1 (mm)	2 (mm)	3 (mm)	4 (mm)	5 (mm)	6 (mm)	WEIGHT (gr)	QTY / BOX INNER/MASTER
WR-ST0207	E6 X E8	113	6	6	8	5	6	19	1 / 300 pcs
WR-ST0208	E7 X E11	126	7	7	11	6	7	32	1 / 400 pcs
WR-ST0209	E10 X E12	140	9	10	12	7	8	42	1 / 300 pcs
WR-ST0210	E14 X E18	181	12	14	18	8	10	86	1 / 200 pcs
WR-ST0211	E16 X E22	201	13	16	22	10	11	131	1 / 150 pcs
WR-ST0212	E20 X E24	225	14	20	24	11	13	175	1 / 50 pcs

- Material is Chrome vanadium steel
- Dropped Forged
- German Type (DIN 899)
- Polished Finish
- Specially designed for E-Torx fastener



CONSTRUCTION WRENCH
KUNCI KONSTRUKSI

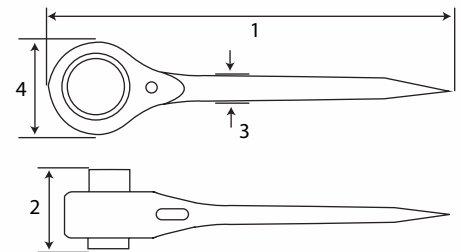

ITEM CODE	SIZE	1 (mm)	2 (mm)	3 (mm)	4 (mm)	WEIGHT (gr)	QTY / BOX INNER/MASTER
WR-CS0217	12 X 14 mm	241	37	11	27	192	2 / 60 pcs
WR-CS0218	14 X 17 mm	280	44	14	34	277	2 / 60 pcs
WR-CS0219	17 X 19 mm	315	49	17	43	468	2 / 50 pcs
WR-CS0220	19 X 21 mm	317	50	17	51	449	2 / 50 pcs
WR-CS0221	21 X 23 mm	360	55	22	60	792	2 / 30 pcs
WR-CS0222	22 X 24 mm	317	54	22	66	799	2 / 30 pcs
WR-CS0223	24 X 27 mm	360	56	23	51	867	2 / 30 pcs
WR-CS0224	27 X 30 mm	450	59	24	80	970	2 / 20 pcs
WR-CS0225	30 X 32 mm	450	63	25	89	1,011	2 / 20 pcs

- Chrome Molybdenum
- Torque and Hardness Exceeds DIN 899 Specification
- 32 teeth Ratchet
- Tip end can be used to twist Wire

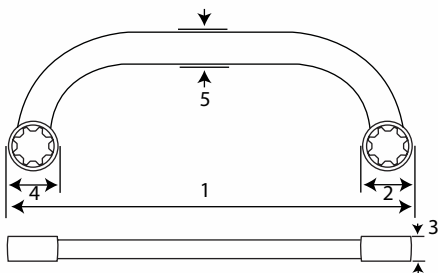

- Chrome vanadium steel
- Dropped forged
- Curved design for maximum access in confined areas
- Polished finish

OBSTRUCTION WRENCH

KUNCI RING BULAN

ITEM CODE	SIZE	1 (mm)	2 (mm)	3 (mm)	4 (mm)	5 (mm)	WEIGHT (gr)	QTY / BOX INNER/MASTER
WR-OB0226	10 X 12 mm	142	18	7	16	10	70	1 / 200 pcs
WR-OB0227	11 X 13 mm	164	18	8	21	11	118	1 / 200 pcs
WR-OB0228	14 X 17 mm	190	21	8	25	12	148	1 / 100 pcs
WR-OB0229	16 X 18 mm	219	24	10	28	13	218	1 / 60 pcs
WR-OB0230	19 X 22 mm	256	28	10	32	15	304	1 / 60 pcs

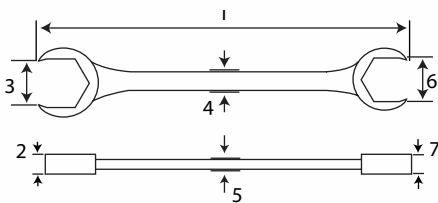

- Chrome vanadium steel
- Dropped forged
- Raised Panel type
- Polished Finish
- The flare nut wrench can be used to remove or replace nuts on fuel or brake lines
- Suits both auto and repair shops

FLARE NUT WRENCH

KUNCI NEPEL

ITEM CODE	SIZE	1 (mm)	2 (mm)	3 (mm)	4 (mm)	5 (mm)	6 (mm)	7 (mm)	WEIGHT (gr)	QTY / BOX INNER/MASTER
WR-FN0213	8 X 10 mm	152	5	8	10	4	10	7	47	24 / 360 pcs
WR-FN0214	10 X 12 mm	155	7	10	10	5	12	9	62	24 / 360 pcs
WR-FN0215	12 X 14 mm	174	9	12	12	6	14	12	97	24 / 240 pcs
WR-FN0216	14 X 17 mm	180	12	13	13	11	17	15	118	24 / 144 pcs

T-TYPE WRENCHES

TEKIRO T-Type Wrenches are manufactured from high strength and durable Chrome Vanadium alloy. It is designed to ease gripping, handling & increase torque performance. Rounded tip finish for better gripping and holding screws. Special surface treatment to prevent oxidation and corrosion. All Tekiro T-Type wrenches exceed JIS standards.

TEKIRO combination wrenches are supplied in 6 different variants : **T-Type Wrench Standard**, **T-Type Wrench Rubber Handle**, **T-Type Wrench Rotary**, **T-Type Wrench Adaptor**, **T-Type Wrench Screwdriver**, **T-Type Wrench Extra Long**.

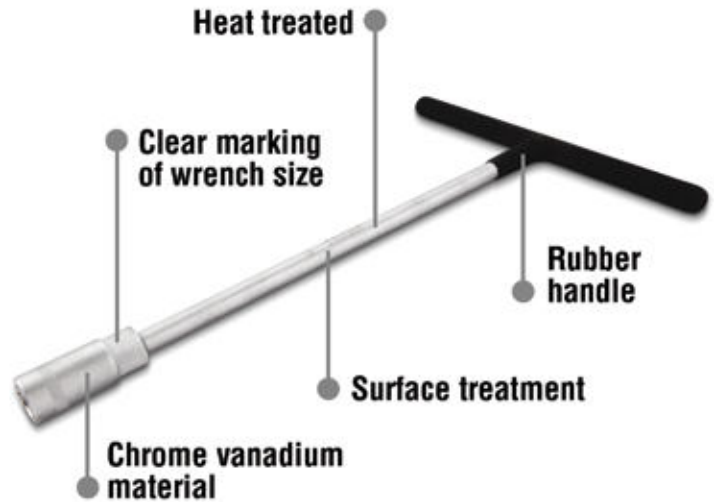

T-TYPE WRENCH ROTARY

TEKIRO T-Type Wrench rotary feature Free rotating grip for better control and speed.



T-TYPE WRENCH EXTRA LONG

TEKIRO T-Type wrench extra long enables greater access where standard T-Type wrench could not reach.



T-TYPE WRENCH ADAPTOR

TEKIRO T-Type Wrench adaptor features free rotating grip for better control, speed and can be used on a variety of sockets.



T-TYPE WRENCH SCREWDRIVER

TEKIRO T-Type wrench screwdriver enables greater access where standard screwdriver could not reach



- Chrome vanadium steel on socket head
- Heat treated for extra durability and strength

T-TYPE BOX WRENCH

T-TYPE SOCKET

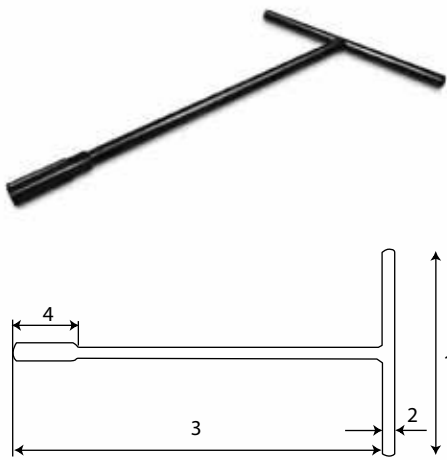

ITEM CODE	SIZE	1 (mm)	2 (mm)	3 (mm)	4 (mm)	5 (mm)	6 (mm)	7 (mm)	WEIGHT (gr)	QTY / BOX INNER/MASTER
WR-TT0231	7 mm	200	10	300	49	11 - 13	8	11	310	1 / 50 pcs
WR-TT0232	8 mm	200	10	300	52	11 - 13	8	11	311	1 / 50 pcs
WR-TT0233	9 mm	200	10	300	52	12 - 13	9	12	320	1 / 50 pcs
WR-TT0234	10 mm	200	10	300	49	14 - 15	10	13	315	1 / 50 pcs
WR-TT0235	11 mm	200	10	300	52	17 - 18	11	14	330	1 / 50 pcs
WR-TT0236	12 mm	200	10	300	52	17 - 19	12	15	350	1 / 50 pcs
WR-TT0237	13 mm	200	10	300	52	18 - 21	13	15	340	1 / 50 pcs
WR-TT0238	14 mm	200	10	300	49	20 - 22	14	16	350	1 / 50 pcs
WR-TT0239	17 mm	200	10	300	52	24 - 25	17	22	372	1 / 50 pcs
WR-TT0240	19 mm	200	10	300	52	27 - 28	19	23	390	1 / 50 pcs

- Chrome vanadium steel on socket head
- With heat treatment for extra durability and strength
- Anti slip rubber handle

T-TYPE BOX WRENCH MATTED COATING HANDLE

T-TYPE SOCKET GAGANG KARET

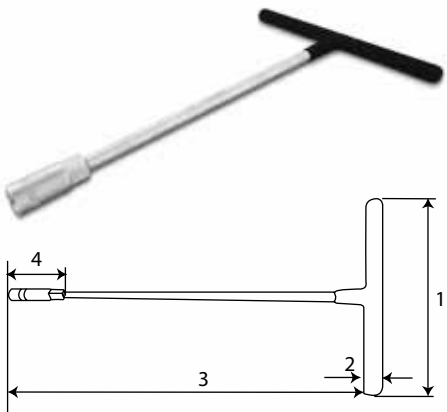

ITEM CODE	SIZE	1 (mm)	2 (mm)	3 (mm)	4 (mm)	5 (mm)	6 (mm)	7 (mm)	WEIGHT (gr)	QTY / BOX INNER/MASTER
WR-TT0241	8 mm	200	13	300	48	12 - 13	8	10	323	1 / 50 pcs
WR-TT0242	10 mm	200	13	300	48	12 - 14	10	12	336	1 / 50 pcs
WR-TT0243	11 mm	201	12	300	50	12 - 15	11	14	352	1 / 50 pcs
WR-TT0244	12 mm	200	13	300	49	12 - 15	12	15	365	1 / 50 pcs
WR-TT0245	13 mm	200	13	300	49	12 - 17	13	15	376	1 / 50 pcs
WR-TT0246	14 mm	200	13	300	50	12 - 18	14	16	379	1 / 50 pcs
WR-TT0247	17 mm	200	13	300	51	12 - 19	17	20	406	1 / 50 pcs
WR-TT0248	19 mm	201	12	300	51	12 - 26	19	23	404	1 / 50 pcs

- Chrome vanadium steel on socket head
- With heat treatment for extra durability and strength
- Free rotating grip for better control and speed

T-TYPE WRENCH (ROTARY TYPE)

T-TYPE SOCKET (PUTAR)

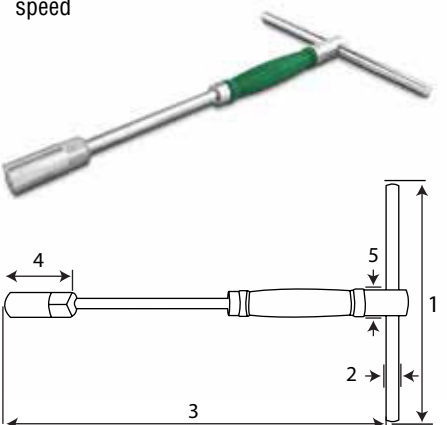

ITEM CODE	SIZE	1 (mm)	2 (mm)	3 (mm)	4 (mm)	5 (mm)	6 (mm)	7 (mm)	WEIGHT (gr)	QTY / BOX INNER/MASTER
WR-TT0249	8 mm	200	10	300	50	17	17	8	379	1 / 50 pcs
WR-TT0250	10 mm	200	10	300	50	15	13	10	394	1 / 50 pcs
WR-TT0251	11 mm	200	10	300	50	16	16	11	406	1 / 50 pcs
WR-TT0252	12 mm	200	10	300	50	16	17	12	415	1 / 50 pcs
WR-TT0253	13 mm	200	10	300	50	15	18	13	425	1 / 50 pcs
WR-TT0254	14 mm	200	10	300	50	18	19	14	430	1 / 50 pcs
WR-TT0255	17 mm	200	10	300	50	18	24	17	460	1 / 50 pcs
WR-TT0256	19 mm	200	10	300	50	17	25	19	466	1 / 50 pcs

T-TYPE ADAPTOR (ROTARY TYPE)

T-TYPE SOCKET WITH ADAPTOR (PUTAR)

ITEM CODE	SIZE	1 (mm)	2 (mm)	3 (mm)	4 (mm)	5 (mm)	WEIGHT (gr)	QTY / BOX INNER/MASTER
WR-TT0257	1/2"	200	95	175	9	12	420	1 / 50 pcs

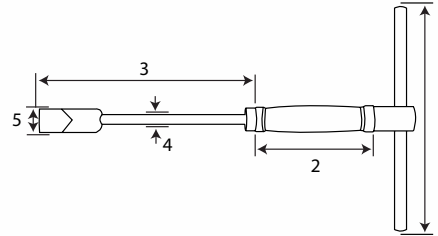

- Material is Chrome vanadium steel on head socket
- With heat treatment for extra durability and strength
- Free rotating grip for better control and speed
- 1/2" DR. Adaptor head



T-TYPE SCREWDRIVER

T-TYPE SOCKET OBENG

ITEM CODE	SIZE	1 (mm)	2 (mm)	3 (mm)	4 (mm)	5 (mm)	WEIGHT (gr)	QTY / BOX INNER/MASTER
WR-TT0258	PH2	200	97	161	6	6	171	1 / 50 pcs
WR-TT0259	PH3	200	95	170	7	7	246	1 / 50 pcs

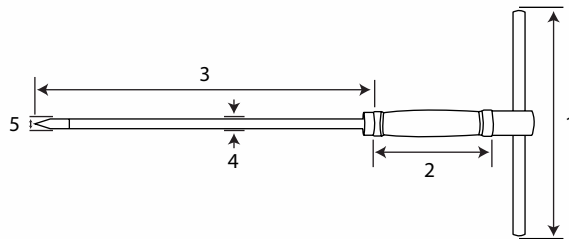

- Material is Chrome vanadium steel on head socket
- With heat treatment for extra durability and strength
- Free rotating grip for better control and speed
- Magnetic tip



T HANDLE

T-TYPE SOCKET EXTRA PANJANG

ITEM CODE	SIZE	1 (mm)	2 (mm)	3 (mm)	4 (mm)	5 (mm)	6 (mm)	WEIGHT (gr)	QTY / BOX INNER/MASTER
WR-TT0261	500 X 8 mm	199	450	47	8	18	10	470	1 / 50 pcs
WR-TT0262	500 X 10 mm	200	460	46	10	19	9	479	1 / 50 pcs
WR-TT0263	500 X 12 mm	200	460	45	15	20	9	479	1 / 50 pcs
WR-TT0264	500 X 14 mm	200	460	45	17	20	9	481	1 / 50 pcs

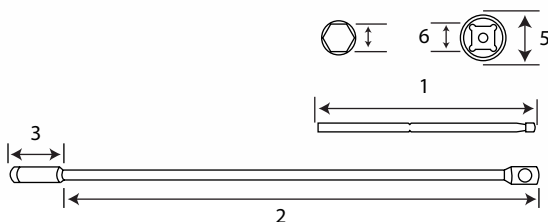

- Material is Chrome vanadium steel on head socket
- With heat treatment for extra durability and strength
- Universal joint model with removable sliding bar handle
- Extra-Long design to avoid burns from engine heat



WRENCH

TORQUE

SOCKET

IMPACT SOCKET

PLIER

SCREWDRIVER

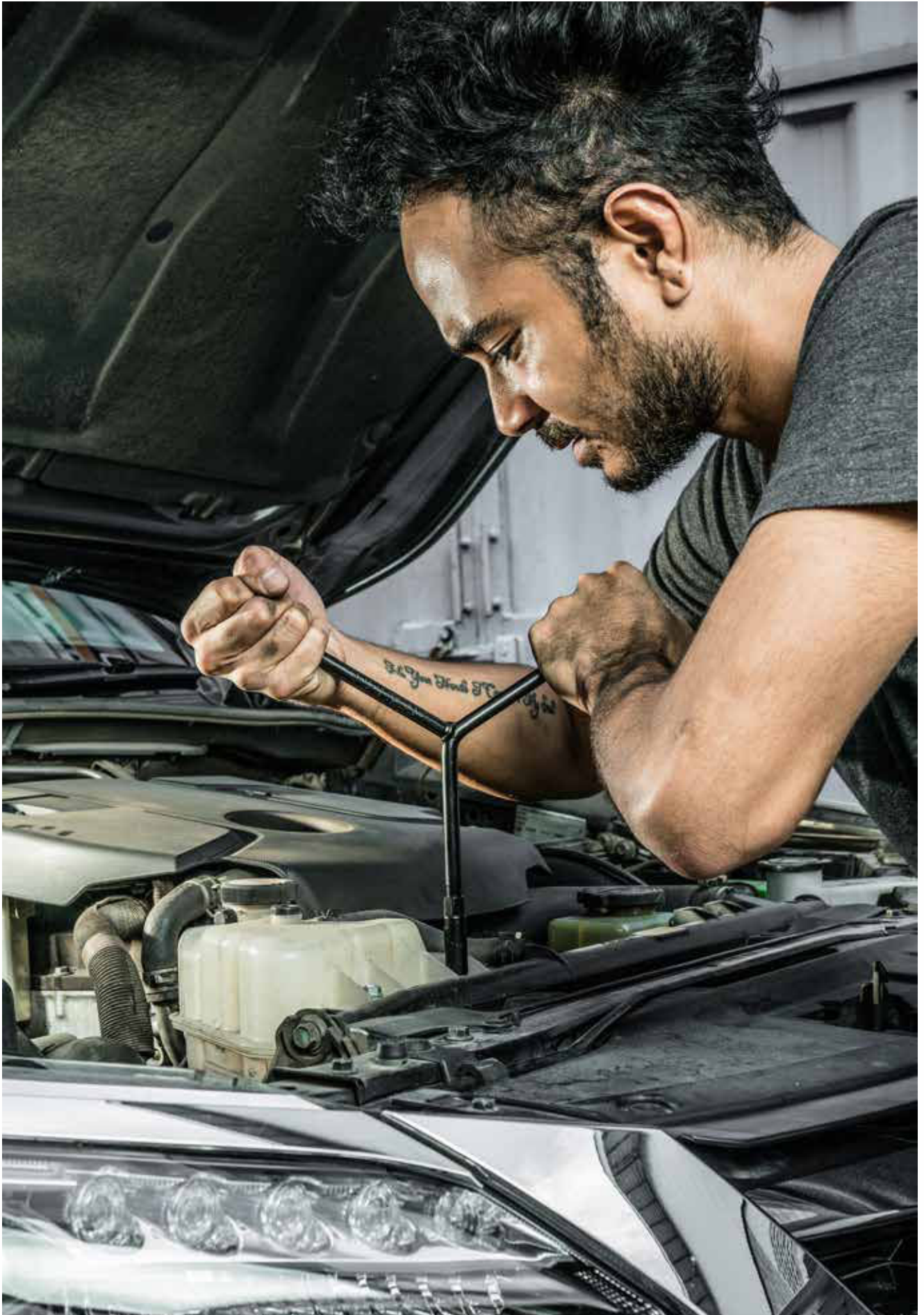

Y-SOCKET WRENCH

Y-TYPE SOCKET

ITEM CODE	SIZE	1 (mm)	2 (mm)	3 (mm)	4 (mm)	WEIGHT (gr)	QTY / BOX INNER/MASTER
WR-YT0265	08 - 09 - 10 mm	90	18	8 - 9 - 10	13 - 13 - 16	172	12 / 96 pcs
WR-YT0266	08 - 10 - 12 mm	90	18	8 - 10 - 12	13 - 16 - 19	172	12 / 96 pcs
WR-YT0267	10 - 11 - 13 mm	90	18	10 - 11 - 13	16 - 15 - 18	182	12 / 96 pcs
WR-YT0268	10 - 12 - 14 mm	90	18	10 - 12 - 14	16 - 19 - 19	193	12 / 96 pcs
WR-YT0269	12 - 14 - 17 mm	90	18	12 - 14 - 17	19 - 20 - 24	219	12 / 96 pcs

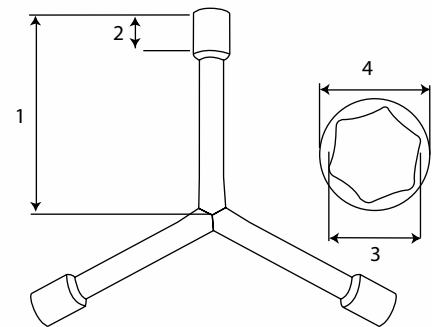

- Chrome vanadium steel on socket head
- Dropped forged

Y-TYPE WRENCH (LONG)

Y-TYPE WRENCH (PANJANG)

ITEM CODE	SIZE	1 (mm)	2 (mm)	3 (mm)	4 (mm)	WEIGHT (gr)	QTY / BOX INNER/MASTER
WR-YT0270	08 - 09 - 10 mm	144	50	8 - 9 - 10	12 - 14 - 14	290	1 / 50 pcs
WR-YT0271	08 - 10 - 12 mm	144	50	8 - 10 - 12	12 - 14 - 17	310	1 / 50 pcs
WR-YT0272	10 - 11 - 13 mm	144	50	10 - 11 - 13	14 - 16 - 18	340	1 / 50 pcs
WR-YT0273	10 - 12 - 14 mm	144	50	10 - 12 - 14	14 - 17 - 20	370	1 / 50 pcs
WR-YT0274	12 - 14 - 17 mm	144	50	12 - 14 - 17	17 - 20 - 24	400	1 / 50 pcs

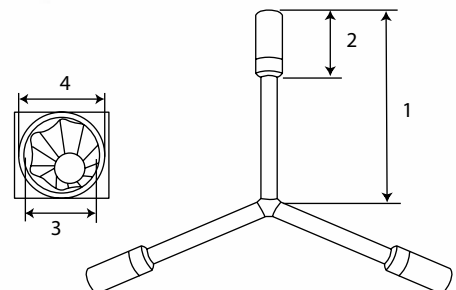

- Chrome vanadium steel on socket head
- Dropped forged
- Extra long shafts for additional leverage and torque

ADJUSTABLE WRENCHES

TEKIRO adjustable wrenches are made for Professional users. It features a large knurl worm for easy adjustment and a tight jaw fit. Its jaw design help reduces slippage and grips tightly on fasteners. The wide I-Beam handle design provides comfort for long term use. Tekiro adjustable wrenches are drop forged for increased toughness and durability.

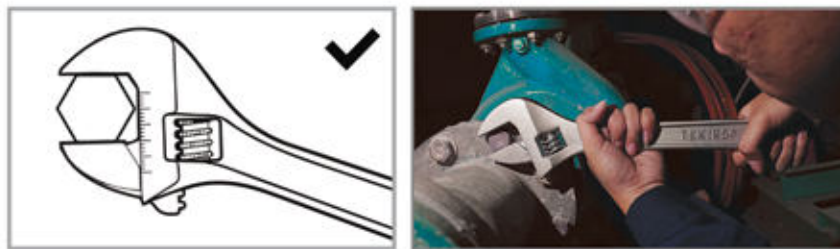

Always ensure there is positive fit onto the fastener

PIPE WRENCHES

TEKIRO Pipe Wrenches are made of one-piece ductile iron casting for heavy duty use. It features a drop forged jaw that is resistant to wear, distortion and breakage. The various sizes of its pipe wrenches are ideal for surfaces such as black, galvanized, PVC and copper pipes.





ADJUSTABLE WRENCH

KUNCI INGGRIS NEW

ITEM CODE	SIZE	1 (mm)	2 (mm)	3 (mm)	4 (mm)	5 (mm)	6 (mm)	WEIGHT (gr)	QTY / BOX INNER/MASTER
WR-AD0280	6"	150	6	12	45	19	20	140	6 / 60 pcs
WR-AD0281	8"	200	7	14	59	24	24	255	6 / 60 pcs
WR-AD0282	10"	250	7	16	70	28	29	425	6 / 36 pcs
WR-AD0283	12"	300	8	20	83	31	34	725	6 / 24 pcs
WR-AD0284	15"	375	11	23	100	39	44	1,370	6 / 12 pcs
WR-AD0285	18"	450	11	25	120	43	55	2,150	1 / 8 pcs
WR-AD0286	24"	595	14	30	412	50	62	4,370	1 / 4 pcs

- Chrome vanadium
- Dropped Forged with heat treatment for extra durability and strength
- Nickel plated finish to resist corrosion
- Laser etched scale
- Precision Machined Jaws
- Knurled Adjustment Worm

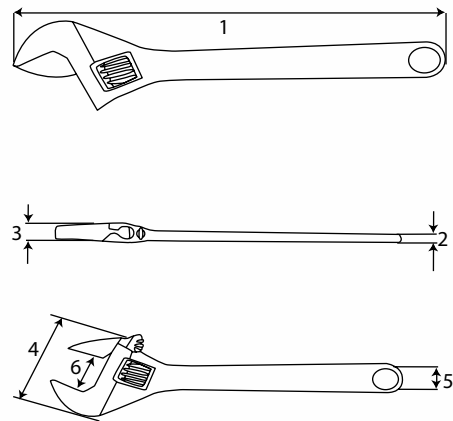

PIPE WRENCH WITHOUT RUBBER HANDLE

KUNCI PIPA

ITEM CODE	SIZE	1 (mm)	2 (mm)	3 (mm)	4 (mm)	5 (mm)	6 (mm)	7 (mm)	8 (mm)	WEIGHT (gr)	QTY / BOX INNER/MASTER
WR-PP0287	6"	77	113	13	10	40	19	12	25	200	6 / 60 pcs
WR-PP0288	8"	91	162	15	11	50	22	16	35	400	6 / 60 pcs
WR-PP0289	10"	115	217	17	14	60	26	19	40	700	6 / 36 pcs
WR-PP0290	12"	139	239	19	16	69	30	21	55	950	6 / 36 pcs
WR-PP0291	14"	158	282	21	17	74	32	23	70	1,400	6 / 24 pcs
WR-PP0292	18"	179	369	24	16	87	37	28	80	2,050	6 / 12 pcs
WR-PP0293	24"	210	470	29	23	99	40	30	90	3,550	6 / 12 pcs
WR-PP0294	36"	250	720	31	25	129	48	36	100	6,500	3 / 6 pcs
WR-PP0295	48"	316	980	33	29	160	59	46	125	11,500	2 / 4 pcs

- One piece ductile iron casted with I-Beam design for extra strength
- The full floating forged hook jaw allows for superior gripping and quick adjustments
- Hardened and tempered teeth provide excellent bite

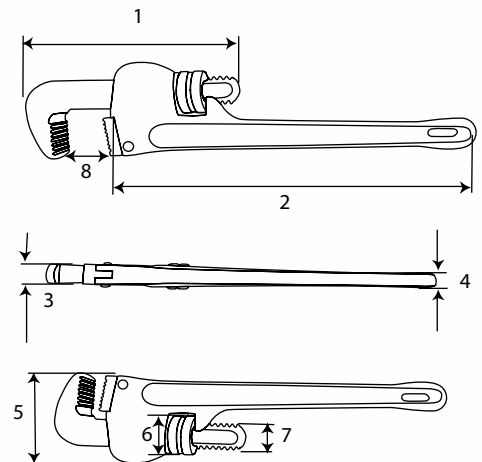

WRENCH

TORQUE

SOCKET

IMPACT SOCKET

PLIER

SCREWDRIVER

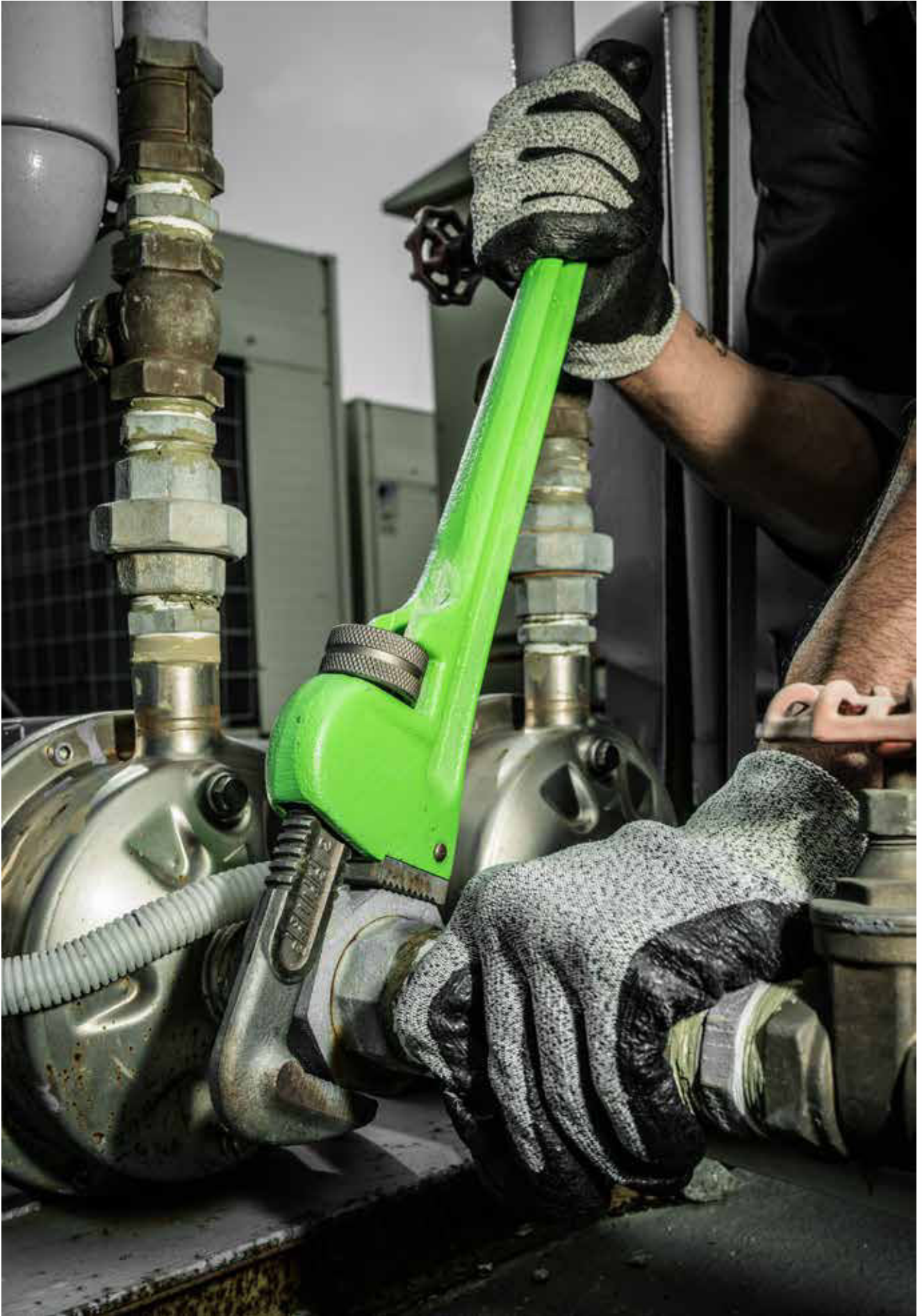

COMBINATION WRENCH SET

KUNCI RING PAS SET

ITEM CODE	SIZE	CONTENT	WEIGHT (gr)	QTY / BOX INNER/MASTER
WR-SE0296	11 pcs (8 - 24 mm)	8mm, 9 mm, 10 mm, 11 mm, 12 mm, 13 mm 14 mm, 17 mm, 19 mm, 22 mm, 24 mm	1,667	1 / 10 set
WR-SE0297	14 pcs (8 - 24 mm)	8 mm, 9 mm, 10 mm, 11 mm, 12 mm, 13 mm 14 mm, 15 mm, 16 mm, 17 mm, 19 mm, 21 mm 22 mm, 24 mm	2,101	1 / 10 set
WR-SE0298	14 pcs (8 - 32 mm)	8 mm, 9 mm, 10 mm, 11 mm, 12 mm, 13 mm 14 mm, 17 mm, 19 mm, 22 mm, 24 mm, 27 mm 30 mm, 32 mm	3,778	1 / 6 set
WR-SE0299	11 pcs (5/16" - 1")	5/16", 3/8", 7/16", 1/2", 9/16", 5/8", 11/16", 3/4" 13/16", 7/8", 1"	1,992	1 / 10 set
WR-SE0300	14 pcs (3/8"-1 1/4")	3/8", 7/16", 1/2", 9/16", 5/8", 11/16", 3/4", 13/16" 7/8", 15/16", 1", 1 1/8", 1 1/8", 1 1/4"	4,481	1 / 6 set

- Set comes with a heavy duty storage pouch
- Raised panel wrench design provides better strength and grip



BOX END WRENCH SET

KUNCI RING SET

ITEM CODE	SIZE	CONTENT	WEIGHT (gr)	QTY / BOX INNER/MASTER
WR-SE0301	8 pcs (6 - 24 mm)	6 X 7 mm, 8 X 9 mm, 10 X 11 mm 12 X 13 mm, 14 X 15 mm, 16 X 17 mm 19 X 21 mm, 22 X 24 mm	1,064	1 / 10 set
WR-SE0302	12 pcs (6 - 32 mm)	6 X 7 mm, 8 X 9 mm, 10 X 11 mm 12 X 13 mm, 14 X 15 mm, 16 X 17 mm 19 X 21 mm, 21 X 23 mm, 22 X 24 mm 24 X 27 mm, 25 X 28 mm, 30 X 32 mm	3,833	1 / 6 set
WR-SE0303	8 pcs (1/4" - 1 1/4")	1/4" X 5/16", 3/8" X 7/16", 1/2" X 9/16" 5/8" X 11/16", 3/4" X 13/16", 7/8" X 15/16" 1 X 1 1/8", 1 1/8" X 1 1/4"	2,767	1 / 6 set
WR-SE0304	8 pcs 75 degree (6 - 24 mm)	6 X 7 mm, 8 X 9 mm, 10 X 11 mm 12 X 13 mm, 14 X 15 mm, 16 X 17 mm 19 X 21 mm, 22 X 24 mm	1,690	1 / 10 set

- Set comes with a heavy duty storage pouch
- Raised panel wrench design provides better strength and grip
- Offset at 45° for ease of access



OPEN END WRENCH SET

KUNCI PAS SET

ITEM CODE	SIZE	CONTENT	WEIGHT (gr)	QTY / BOX INNER/MASTER
WR-SE0305	8 pcs (6 - 24 mm)	6 X 7 mm, 8 X 9 mm, 10 X 11 mm 12 X 13 mm, 14 X 15 mm, 16 X 17 mm 19 X 21 mm, 22 X 24 mm	1,042	1 / 10 set
WR-SE0306	12 pcs (6 - 32 mm)	6 X 7 mm, 8 X 9 mm, 10 X 11 mm 12 X 13 mm, 14 X 15 mm, 16 X 17 mm 19 X 21 mm, 21 X 23 mm, 22 X 24 mm 24 X 27 mm, 25 X 28 mm, 30 X 32 mm	3,050	1 / 10 set
WR-SE0307	8 pcs (1/4" - 1 1/4")	1/4" X 5/16", 3/8" X 7/16", 1/2" X 9/16" 3/8" X 11/16", 3/4" X 13/16" 7/8" X 15/16", 1 X 1 1/8", 1 1/8" X 1 1/4"	2,161	1 / 10 set

- Set comes with a heavy duty storage pouch
- Raised panel wrench design provides better strength and grip



WRENCH

TORQUE

SOCKET

IMPACT SOCKET

PLIER

SCREWDRIVER

- Set comes with a heavy duty storage pouch
- Sunk Panel type with Silver Matt Finish
- Dropped forged Chrome Vanadium Material



COMBINATION WRENCH SET - SUNK PANEL

KUNCI RING PAS SET - SUNK PANEL

ITEM CODE	SIZE	CONTENT	WEIGHT (gr)	QTY / BOX INNER/MASTER
WR-SE0308	11 pcs (8 - 24 mm)	8 mm, 9 mm, 10 mm, 11 mm	1,450	1 / 10 set
		12 mm, 13 mm, 14 mm, 17 mm		
		17 mm, 19 mm, 22 mm, 24 mm		
WR-SE0309	14 pcs (8 - 24 mm)	8 mm, 9 mm, 10 mm, 11 mm	1,650	1 / 10 set
		12 mm, 13 mm, 14 mm, 15 mm		
		16 mm, 17 mm, 19 mm, 21 mm		
		22 mm, 24 mm		
WR-SE0310	14 pcs (8 - 32 mm)	8 mm, 9 mm, 10 mm, 11 mm	3,766	1 / 6 set
		12 mm, 13 mm, 14 mm, 17 mm		
		19 mm, 22 mm, 24 mm, 27 mm		
		30 mm, 32 mm		

- Set comes with a heavy duty storage pouch
- Offset at 45° for ease of access
- Sunk Panel type with Silver Matt Finish
- Dropped forged Chrome Vanadium Material



BOX END WRENCH SET - SUNK PANEL

KUNCI RING SET - SUNK PANEL

ITEM CODE	SIZE	CONTENT	WEIGHT (gr)	QTY / BOX INNER/MASTER
WR-SE0311	8 pcs (6 - 24 mm)	6 X 7 mm, 8 X 9 mm, 10 X 11 mm	1,690	1 / 10 set
		12 X 13 mm, 14 X 15 mm, 16 X 17 mm		
		19 X 21 mm, 22 X 24 mm		
WR-SE0312	12 pcs (6 - 32 mm)	6 X 7 mm, 8 X 9 mm, 10 X 11 mm	2,817	1 / 6 set
		12 X 13 mm, 14 X 15 mm, 16 X 17 mm		
		19 X 21 mm, 21 X 23 mm, 22 X 24 mm		
		24 X 27 mm, 25 X 28 mm, 30 X 32 mm		

- Set comes with a heavy duty storage pouch
- Sunk Panel type with Silver Matt Finish
- Dropped forged Chrome Vanadium Material



OPEN END WRENCH SET - SUNK PANEL

KUNCI PAS SET - SUNK PANEL

ITEM CODE	SIZE	CONTENT	WEIGHT (gr)	QTY / BOX INNER/MASTER
WR-SE0313	8 pcs (6 - 24 mm)	6 X 7 mm, 8 X 9 mm, 10 X 11 mm	1,200	1 / 10 set
		12 X 13 mm, 14 X 15 mm, 16 X 17 mm		
		19 X 21 mm, 22 X 24 mm		
WR-SE0314	12 pcs (6 - 32 mm)	6 X 7 mm, 8 X 9 mm, 10 X 11 mm	2,700	1 / 8 set
		12 X 13 mm, 14 X 15 mm, 16 X 17 mm		
		19 X 21 mm, 21 X 23 mm, 22 X 24 mm		
		24 X 27 mm, 25 X 28 mm, 30 X 32 mm		

STAR WRENCH SET 6 PCS

KUNCI RING BINTANG SET 6 PCS

ITEM CODE	SIZE	CONTENT	WEIGHT (gr)	QTY / BOX INNER/MASTER
WR-SR0315	6 pcs (E6 - E24)	E6 X E8, E7 X E11, E10 X E12 E14 X E18, E16 X E22, E20 X E24	1,120	1 / 10 set

- Set comes with a heavy duty metal case
- Sunk Panel type with Silver Matt Finish
- Dropped forged Chrome Vanadium Material



OBSTRUCTION WRENCH SET

KUNCI RING BULAN SET

ITEM CODE	SIZE	CONTENT	WEIGHT (gr)	QTY / BOX INNER/MASTER
WR-OS0316	5 pcs (10 - 22 mm)	10 X 12 mm, 11 X 13 mm, 14 X 17 mm 16 X 18 mm, 19 X 22 mm	901	1 / 16 set

- Chrome Vanadium material
- Drop Forged for extra strength
- Polished finished
- Set comes with a heavy duty tray



BIKE TOOLKIT SET 6 PCS

KUNCI SEPEDA SET 6 PCS

ITEM CODE	CONTENT	WEIGHT (gr)	QTY / BOX INNER/MASTER
WR-BK0317	4 pcs Hex Key 3 mm, 4 mm, 5 mm, 6 mm	192	10 / 60 set
	1 pcs Torx Key T25		
	1 pcs Screwdriver Tip PH #2		

- Heat Treated
- Hardened and tempered
- Chrome Vanadium steel
- Placed in the pouch bag, easy to carry



WRENCH

TORQUE

SOCKET

IMPACT SOCKET

PLIER

SCREWDRIVER

- Heat Treated
- Hardened and tempered
- Chrome Vanadium steel
- Placed in the pouch bag, easy to carry



BIKE TOOLKIT SET 10 PCS

KUNCI SEPEDA SET 10 PCS

ITEM CODE	CONTENT		WEIGHT (gr)	QTY / BOX INNER/MASTER
WR-BK0318	7 pcs	Hex Key 2 mm, 2.5 mm, 3 mm, 4 mm, 5 mm 6 mm, 8 mm	233	10 / 60 set
	1 pcs	Torx Key T25		
	2 pcs	Screwdriver Tip Slotted 5 mm, PH #2		

- Heat Treated
- Hardened and tempered
- Chrome Vanadium steel
- Placed in the pouch bag, easy to carry



BIKE TOOLKIT SET 15 PCS

KUNCI SEPEDA SET 15 PCS

ITEM CODE	CONTENT		WEIGHT (gr)	QTY / BOX INNER/MASTER
WR-BK0319	7 pcs	Hex Key 2 mm, 2.5 mm, 3 mm, 4 mm, 5 mm 6 mm, 8 mm	300	10 / 40 set
	2 pcs	Torx Key T10, T25		
	1 pcs	Screwdriver Tip Flat 5 mm, PH #2		
	4 pcs	Chain Wrench + Screw Spoke Wrench 14 G, 15 G, 0.136"		

- Chrome vanadium
- Chrome nickel plated finishing
- Drop forged
- thin wall ideal for fastening and loosening coupling nuts

COUPLING NUT WRENCH

KUNCI BLOK MESIN

ITEM CODE	SIZE	1 (mm)	2 (mm)	3 (mm)	4 (mm)	5 (mm)	6 (mm)	7 (mm)	WEIGHT (gr)	QTY / BOX INNER/MASTER
WR-CN1456	39 X 41	270	39	41	62	62	24	4	403	6 / 36 pcs

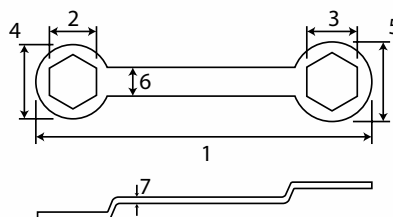

DOUBLE SWIVEL WRENCH

KUNCI SOCK GANDA FLEXIBLE

ITEM CODE	SIZE	1 (mm)	2 (mm)	3 (mm)	WEIGHT (gr)	QTY / BOX INNER/MASTER
WR-DS1594	8 X 10 mm (12 pt)	200	9	13	90.5	12 / 120 pcs
WR-DS1595	10 X 12 mm (12 pt)	220	11	14	124.5	12 / 120 pcs
WR-DS1596	12 X 14 mm (12 pt)	236	14	18	177.0	12 / 120 pcs
WR-DS1597	14 X 17 mm (12 pt)	250	16	20	220.5	12 / 60 pcs



- Chrome vanadium material
- Drop forged for extra strength
- 12 pt polished socket head
- Body, silver matt finishing
- Swivel head for easy access to tight and narrow space



COMBINATION WRENCH SET 4 PCS

KUNCI RING PAS SET 4 PCS

ITEM CODE	SIZE	SIZE	WEIGHT (gr)	QTY / BOX INNER/MASTER
WR-SE1643	4 pcs	Combination Wrench 10 mm	374	5 / 50 set
		Combination Wrench 12 mm		
		Combination Wrench 14 mm		
		Combination Wrench 17 mm		

- Set comes with a heavy duty storage pouch
- Raised panel wrench design provides better strength and grip



COMBINATION WRENCH SET 8 PCS

KUNCI RING PAS SET 8 PCS

ITEM CODE	SIZE	SIZE	WEIGHT (gr)	QTY / BOX INNER/MASTER
WR-SE1644	8 pcs	Combination Wrench 8 mm	678	1 / 20 set
		Combination Wrench 10 mm		
		Combination Wrench 11 mm		
		Combination Wrench 12 mm		
		Combination Wrench 13 mm		
		Combination Wrench 14 mm		
		Combination Wrench 17 mm		
		Combination Wrench 19 mm		

- Set comes with a heavy duty storage pouch
- Raised panel wrench design provides better strength and grip



WRENCH

TORQUE

SOCKET

IMPACT SOCKET

PLIER

SCREWDRIVER

- Set comes with a heavy duty storage pouch
- Raised panel wrench design provides better strength and grip
- Offset at 45° for ease of access and feature



BOX END WRENCH SET 3 PCS

KUNCI RING SET 3 PCS

ITEM CODE	SIZE	CONTENT	WEIGHT (gr)	QTY / BOX INNER/MASTER
WR-SE1645	3 pcs	Box End Wrench 10 X 11 mm	409	5 / 50 set
		Box End Wrench 12 X 13 mm		
		Box End Wrench 14 X 15 mm		

- Set comes with a heavy duty storage pouch
- Raised panel wrench design provides better strength and grip
- Offset at 45° for ease of access and feature



BOX END WRENCH SET 5 PCS

KUNCI RING SET 5 PCS

ITEM CODE	SIZE	CONTENT	WEIGHT (gr)	QTY / BOX INNER/MASTER
WR-SE1646	5 pcs	Box End Wrench 8 X 9 mm	791	1 / 20 set
		Box End Wrench 10 X 11 mm		
		Box End Wrench 12 X 13 mm		
		Box End Wrench 14 X 15 mm		
		Box End Wrench 17 X 19 mm		

- Set comes with a heavy duty storage pouch
- Raised panel wrench design provides better strength and grip



OPEN END WRENCH SET 3 PCS

KUNCI PAS SET 3 PCS

ITEM CODE	SIZE	CONTENT	WEIGHT (gr)	QTY / BOX INNER/MASTER
WR-SE1647	3 pcs	Open End Wrench 10 X 11 mm	256	5 / 50 set
		Open End Wrench 12 X 13 mm		
		Open End Wrench 14 X 15 mm		

OPEN END WRENCH SET 5 PCS

KUNCI PAS SET 5 PCS

ITEM CODE	SIZE	CONTENT	WEIGHT (gr)	QTY / BOX INNER/MASTER
WR-SE1648	5 pcs	Open End Wrench 8 X 9 mm	491	1 / 20 set
		Open End Wrench 10 X 11 mm		
		Open End Wrench 12 X 13 mm		
		Open End Wrench 14 X 15 mm		
		Open End Wrench 17 X 19 mm		

- Set comes with a heavy duty storage pouch
- Raised panel wrench design provides better strength and grip



T-TYPE BOX WRENCH SET 3 PCS 8-10-12 MM

T-TYPE SOCKET SET 3 PCS 8-10-12 MM

ITEM CODE	SIZE	CONTENT	WEIGHT (gr)	QTY / BOX INNER/MASTER
WR-TT1871	3	T-Type Socket 8 mm	165	1 / 10 Sets
		T-Type Socket 10 mm		
		T-Type Socket 12 mm		

- Chrome vanadium steel on socket head
- Heat treated for extra durability and strength



HOOK WRENCH

KUNCI KOMSTIR DAN KNALPOT FLEXIBLE

ITEM CODE	SIZE	1 (mm)	2 (mm)	3 (mm)	4 (mm)	WEIGHT (gr)	QTY / BOX INNER/MASTER
WR-HW1848	3/4" - 2"	109	54	8	6	126	20 / 120 pcs
WR-HW1849	1 1/4" - 3"	134	69	6	10	235.5	10 / 80 pcs
WR-HW1850	2" - 4 3/4"	190	97	8	11	450	10 / 40 pcs

- Material is Chrome vanadium steel with heat treatment for extra durability and strength
- Used to tighten side slot nuts on collars, lock nuts and bearings
- Convenient and easy to use

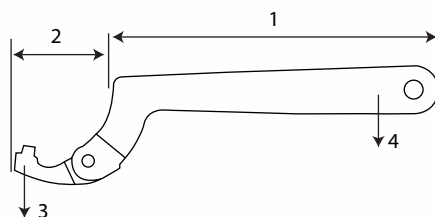

WRENCH

TORQUE

SOCKET

IMPACT SOCKET

PLIER

SCREWDRIVER



- For adjusting nuts on machines, motorbike shocks, car adjustable shocks and anything with castle style nuts

WRENCH D

WRENCH D

ITEM CODE	SIZE	1 (mm)	2 (mm)	3 (mm)	WEIGHT (gr)	QTY / BOX INNER/MASTER
SA-YH1337	164 X 43 X 17 mm	164	43	17	198	5 / 50 pcs

HOW TO USE

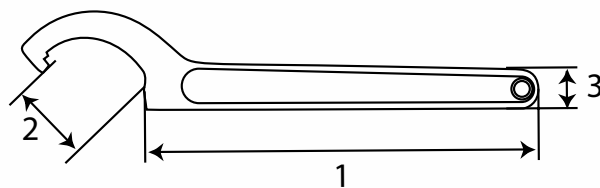

TORQUE



TORQUE WRENCHES

The **TEKIRO** Torque Wrenches provides users with proper bolt tightening and eliminates various errors that might occur during bolt tightening operations. This variant is suitable for industrial applications due to its easy torque adjusting & quick release design. With an easy touch of the switch, we could change both clockwise and anticlockwise directions.

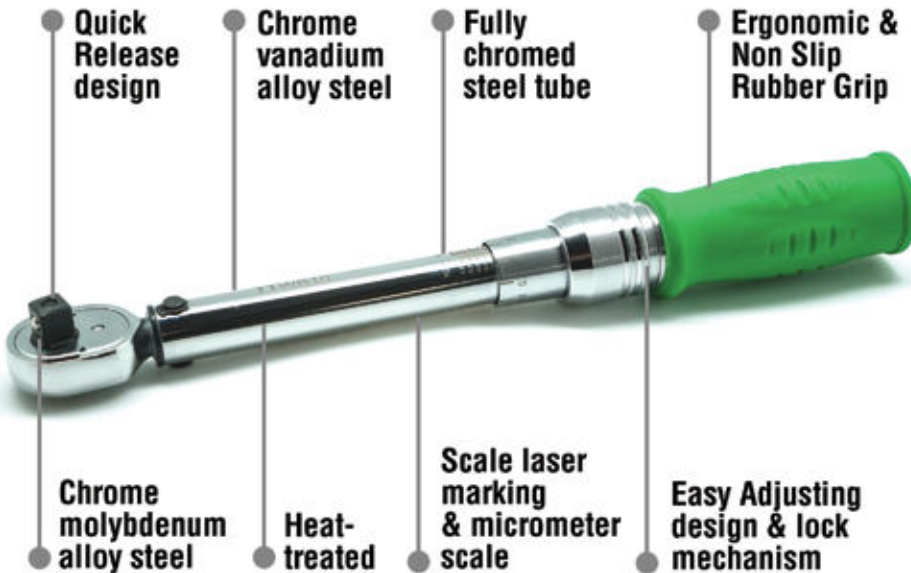

PROFESSIONAL TORQUE WRENCHES

This variant is recognised for its reliability, accuracy and quality due to its unique design and mechanism. Push through reversible square drive connector enables instant direction reversal, retractable torque adjuster that cannot be altered by accident and loud click sound when torque is reached.

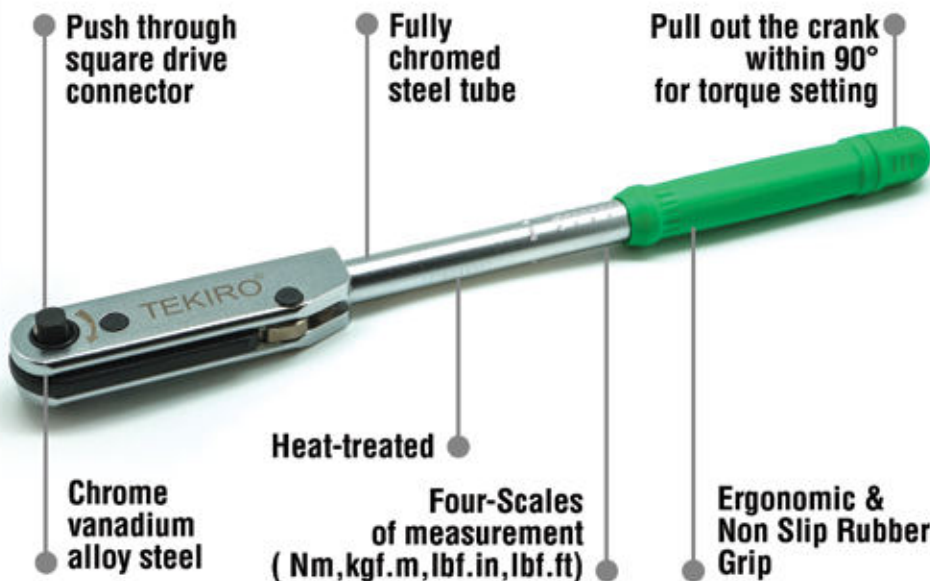



TORQUE WRENCH

KUNCI TORSI

ITEM CODE	SIZE	1 (mm)	2 (mm)	3 (mm)	4 (mm)	WEIGHT (gr)	QTY / BOX INNER/MASTER
TQ-WR0320	TKR 3/8" DR. TORQUE WR. 2 - 10 (N.m) (TR100)	281	156	29	11	827	1 / 24 pcs
TQ-WR0321	TKR 3/8" DR. TORQUE WR. 4 - 20 (N.m) (TR300)	329	206	29	12	643	1 / 24 pcs
TQ-WR0322	TKR 1/2" DR. TORQUE WR. 20 - 100 (N.m) (TR1200)	440	286	36	15	1,320	1 / 12 pcs
TQ-WR0323	TKR 1/2" DR. TORQUE WR. 40 - 200 (N.m) (TR2000)	510	340	44	20	1,570	1 / 12 pcs
TQ-WR0324	TKR 1/2" DR. TORQUE WR. 60 - 340 (N.m) (TR3000)	610	440	44	20	1,770	1 / 12 pcs
TQ-WR0325	TKR 3/4" DR. TORQUE WR. 100 - 600 (N.m) (TR5000)	1,502	780	63	31	5,100	1 / 2 pcs
TQ-WR0326	TKR 1" DR. TORQUE WR. 200 - 1000 (N.m) (TR8400)	1,235	910	68	34	6,219	1 / 2 pcs

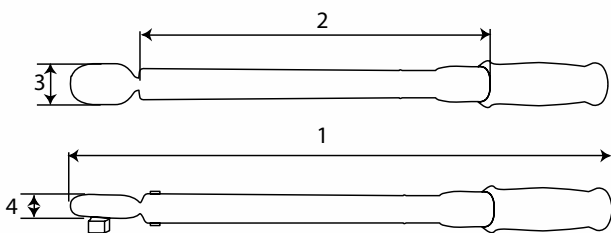

- Industrial application
- Wide range of choice
- Tolerance of torque $\pm 3\%$
- Easy torque-adjusting design
- Quick release design
- Applied to both clockwise and counterclockwise directions
- Quality meets DIN ISO 6789 & ASME B107.300-2010



PROFESSIONAL TORQUE WRENCH

KUNCI TORSI PROFESIONAL

ITEM CODE	SIZE	1 (mm)	2 (mm)	3 (mm)	4 (mm)	WEIGHT (gr)	QTY / BOX INNER/MASTER
TQ-PF0327	3/8" DR. PROFESSIONAL TORQUE WRENCH 2.5 - 11 (N.m) (T100)	351	105	32	30	609	1 / 24 pcs
TQ-PF0328	3/8" DR. PROFESSIONAL TORQUE WRENCH 5 - 33 (N.m) (T300)	450	210	32	30	737	1 / 12 pcs
TQ-PF0329	1/2" DR. PROFESSIONAL TORQUE WRENCH 12 - 68 (N.m) (T600)	505	195	44	32	1050	1 / 12 pcs
TQ-PF0330	1/2" DR. PROFESSIONAL TORQUE WRENCH 25 - 135 (N.m) (T1200)	551	210	49	32	1440	1 / 12 pcs
TQ-PF0331	1/2" DR. PROFESSIONAL TORQUE WRENCH 50 - 225 (N.m) (T2000)	540	205	49	31	1468	1 / 12 pcs
TQ-PF0332	1/2" DR. PROFESSIONAL TORQUE WRENCH 70 - 330 (N.m) (T3000)	796	436	49	31	2,580	1 / 6 pcs
TQ-PF0333	3/4" DR. PROFESSIONAL TORQUE WRENCH 140 - 560 (N.m) (T5000)	995	342	74	49	6,700	1 / 2 pcs
TQ-PF0334	3/4" DR. PROFESSIONAL TORQUE WRENCH 200 - 810 (N.m) (T7200)	1,003	700	74	48	7,033	1 / 2 pcs
TQ-PF0335	1" DR. PROFESSIONAL TORQUE WRENCH 460 - 940 (N.m) (T8400)	1,360	805	80	66	7,839	1 / 1 pcs

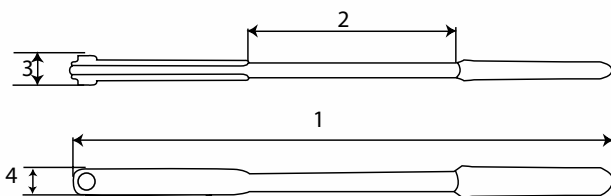

- Industrial application
- Wide range of choice
- Tolerance of torque $\pm 3\%$
- Push through square drive connector for instant directional change
- Loud click sound when required torque is reached
- Retracting torque adjuster brings length independent and accurate torque
- Quality meets DIN ISO 6789 & ASME B107.300-2010



WRENCH

TORQUE

SOCKET

IMPACT SOCKET

PLIER

SCREWDRIVER



DRIVE TORQUE

DRIVE TORSI

ITEM CODE	SIZE	1 (mm)	2 (mm)	3 (mm)	WEIGHT (gr)	QTY / BOX INNER/MASTER
TQ-HT1457	3/8" DR. DRIVE TORQUE 32.6 X 9.52 X 10.5 mm (T100, T300)	33	33	10	21	12 / 12 pcs
TQ-HT1458	1/2" DR. DRIVE TORQUE 44.2 X 12.7 X 14 mm (T600)	44	44	13	52	12 / 12 pcs
TQ-HT1459	1/2" DR. DRIVE TORQUE 48.5 X 12.7 X 14 mm (T1200, T2000, T3000)	48	48	14	57	12 / 72 pcs
TQ-HT1460	3/4" DR. DRIVE TORQUE 73.5 X 19 X 20.75 mm (T5000, T7200)	73	73	14	196	1 / 6 pcs

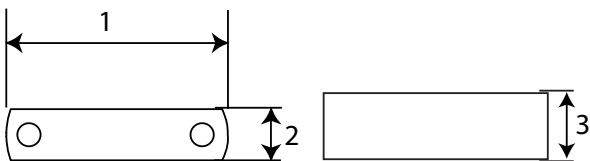

- Material is Chrome Molybdenum
- Industrial Black Oxide finish
- Precision milled
- Corrosion resistance



SOCKET

Hand & Wrench

SOCKET

Is the key tool in any Automotive repair & maintenance environment. The **TEKIRO** Socket & Ratchet wrench range provides professionals with real versatility. Full drive options of 1/4", 1/2" and 3/4" means that you can handle any job - large or small. The precision profiled chrome vanadium sockets with 6, 12 points and spline design, ensure every nut or bolt is gripped securely with maximum torque and minimal wear on the fasteners.

Mechanic tool sets are a convenient collection of sizes to suit most applications. Sets come complete with a full set of extension bars and couplers for versatile applications.

Accompanying the Hand Socket range, is a selection of high grade steel Bit Sockets including star (torx) and Spline profiles - a tool for every task.

TEKIRO socket and accessories are manufactured from the highest quality material using the latest techniques and meets the performance expectations of all professionals.



STRESS RELIEF DRIVE

TEKIRO sockets features a Stress Relief Drive profile that increases the contact area between the socket and the fastener, minimising stress, and reducing the chance of damage to the fastener. The Load is applied to the fastener's flat edge rather than the corners, even if the fastener is already damage, performance will superior to that of a standard profile socket.

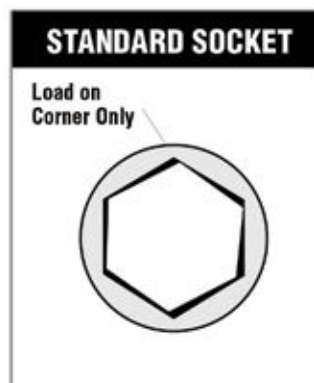
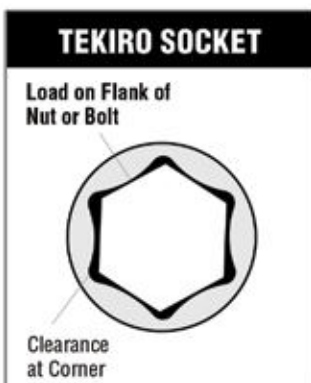

SOCKET CLASSIFICATION BY SHAPE AND LENGTH

SOCKET SHAPE

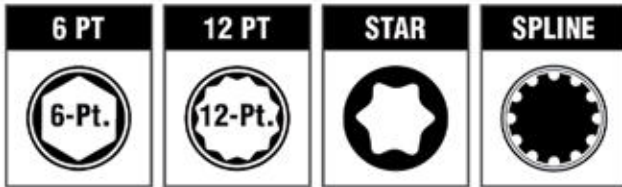

LENGTH

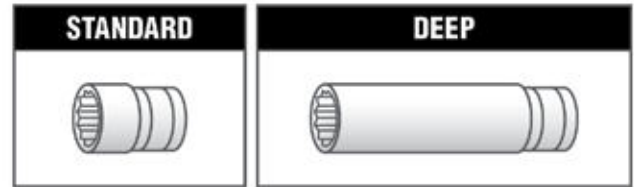

HOW TO USE SOCKETS AND WRENCHES

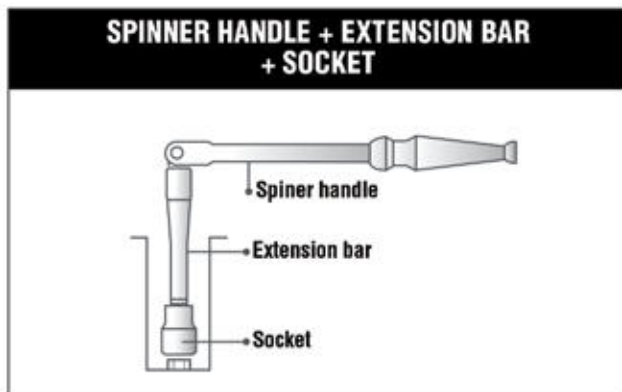
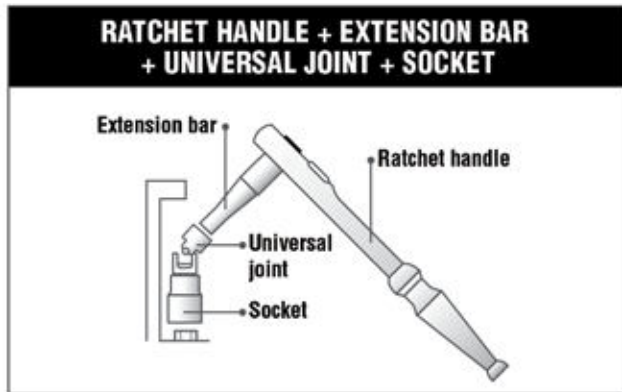

WRENCH

TORQUE

SOCKET

IMPACT SOCKET

PLIER

SCREWDRIVER

1. Do not add any extension pipes to the Ratchet Handle or strike with a hammer.

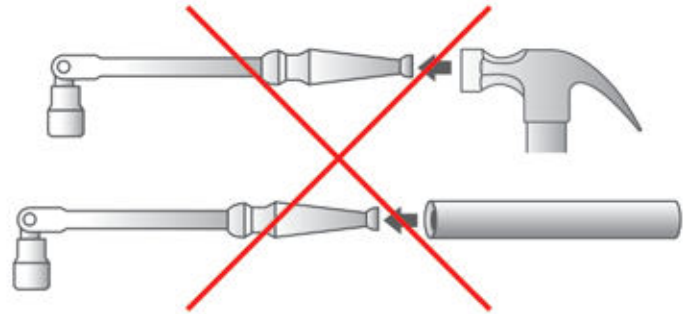

2. Apply force toward the direction of the bolt turning

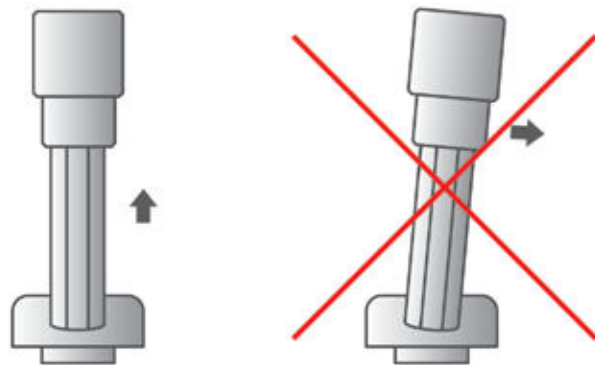

3. Completely cover the bolt /nut with the socket

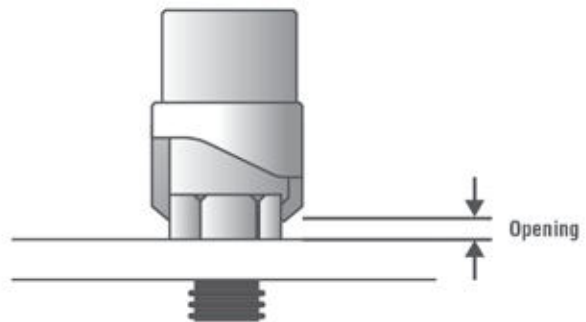



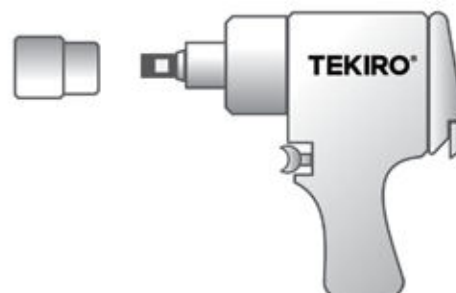

4. Use only Impact Sockets for air impact wrenches





Lorem Ipsum





SOCKET

SOCKET TYPE	STANDARD	DEEP	DRIVE & SOCKET SIZES			
			1/4"	3/8"	1/2"	3/4"
6 PT 	●		4-14 (mm)	8-22 (mm)	8-32 (mm)	19-60 (mm)
6 PT 		●			8-32 (mm)	
12 PT 	●			8-22 (mm)	8-32 (mm)	19-60 (mm)
12 PT 		●			8-32 (mm)	
Spline 	●				8-32 (mm)	



SOCKET SET

SOCKET TYPE	STANDARD	DEEP	DRIVE & SET SIZES			
			1/4"	3/8"	1/2"	3/4"
6 PT 	●		4-24 (mm) 5/32" - 1/2"	6-24 (mm) 3/8" - 7/8"	8-32 (mm)	19-50 (mm)
6 PT 		●	6-13 (mm)		8-32 (mm)	
12 PT 	●			6-24 (mm) 3/8" - 7/8"	8-32 (mm)	19-50 (mm)
12 PT 		●		13-17 (mm)		
Star 	●			E8-E20	E10-E24	

BIT SOCKET

SOCKET TYPE	STANDARD	DEEP	DRIVE & SET SIZES			
			1/4"	3/8"	1/2"	3/4"
6 PT 	●				4-12 (mm)	
Spline 	●				9.5 (mm)	
Star 	●				T40-T50	

BIT SOCKET SET

SOCKET TYPE	STANDARD	DEEP	DRIVE & SET SIZES			
			1/4"	3/8"	1/2"	3/4"
Star 	●				T20-T70	
Hex 	●				H4-H19	

WRENCH

TORQUE

SOCKET

IMPACT SOCKET

PLIER

SCREWDRIVER

- Chrome vanadium material
- Drop Forged for greater strength
- Anti-rust finishing, greater strength and with knurling design for extra grip
- Silver matt finish
- Stress relief design



1/4" DR. HAND SOCKET 6 PT

1/4" DR. KUNCI SOCK 6 PT

ITEM CODE	SIZE	1 (mm)	2 (mm)	3 (mm)	4 (mm)	5 (mm)	6 (mm)	WEIGHT (gr)	QTY / BOX INNER/MASTER
SC-SC0337	4 mm	25	15	7	11	7	4	10	50 / 100 pcs
SC-SC0338	4.5 mm	25	14	7	12	7	5	11	50 / 100 pcs
SC-SC0339	5 mm	24	14	6	11	7	5	11	50 / 100 pcs
SC-SC0340	5.5 mm	25	15	7	12	8	6	11	50 / 100 pcs
SC-SC0341	6 mm	25	15	6	11	9	6	11	50 / 100 pcs
SC-SC0342	7 mm	25	15	7	11	10	7	11	50 / 100 pcs
SC-SC0343	8 mm	25	15	6	11	11	8	11	10 / 100 pcs
SC-SC0344	9 mm	25	15	7	11	12	9	11	10 / 100 pcs
SC-SC0345	10 mm	25	15	7	12	14	10	14	50 / 100 pcs
SC-SC0346	11 mm	25	15	7	14	15	11	18	50 / 100 pcs
SC-SC0347	12 mm	25	15	7	14	17	12	20	50 / 100 pcs
SC-SC0348	13 mm	25	15	7	16	18	13	23	50 / 100 pcs
SC-SC0349	14 mm	25	15	7	18	20	14	28	50 / 100 pcs

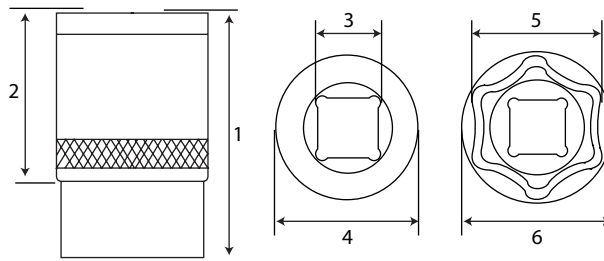

- Chrome vanadium material
- Drop Forged for greater strength
- Anti-rust finishing, greater strength and with knurling design for extra grip
- Silver matt finish
- Stress relief design



3/8" DR. HAND SOCKET 6 PT / 12 PT

3/8" DR. KUNCI SOCK 6 PT / 12 PT

ITEM CODE		SIZE	1 (mm)	2 (mm)	3 (mm)	4 (mm)	5 (mm)	6 (mm)	WEIGHT (gr)	QTY / BOX INNER/MASTER
6 PT	12 PT									
SC-SC0350	SC-SC0362	8 mm	28	18	10	17	12	8	25	20 / 200 pcs
SC-SC0351		9 mm	28	18	10	16	12	9	25	20 / 200 pcs
SC-SC0352	SC-SC0364	10 mm	27	22	10	16	16	10	25	20 / 200 pcs
SC-SC0353		11 mm	28	18	10	17	15	11	25	20 / 200 pcs
SC-SC0354	SC-SC0366	12 mm	28	22	10	15	18	12	23	20 / 200 pcs
SC-SC0355	SC-SC0367	13 mm	27	18	10	16	17	13	27	20 / 200 pcs
SC-SC0356	SC-SC0368	14 mm	27	18	10	16	19	14	30	20 / 200 pcs
SC-SC0357		15 mm	28	18	10	18	20	15	34	20 / 200 pcs
SC-SC0358		16 mm	28	19	10	19	22	16	41	20 / 200 pcs
SC-SC0359	SC-SC0371	17 mm	30	19	10	20	23	17	48	20 / 200 pcs
SC-SC0360		19 mm	30	19	10	23	27	19	63	20 / 200 pcs
SC-SC0361		22 mm	30	19	10	26	30	22	80	10 / 100 pcs

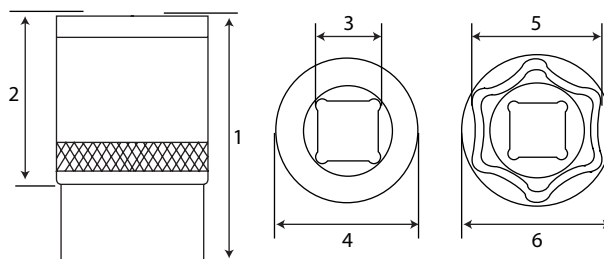

1/2" DR. HAND SOCKET 6 PT / 12 PT

1/2" DR. KUNCI SOCK 6 PT / 12 PT

ITEM CODE		SIZE	1 (mm)	2 (mm)	3 (mm)	4 (mm)	5 (mm)	6 (mm)	WEIGHT (gr)	QTY / BOX INNER/MASTER
6 PT	12 PT									
SC-SC0374	SC-SC0398	8 mm	37	22	13	21	12	8	47	10 / 320 pcs
SC-SC0375	SC-SC0399	9 mm	38	21	13	22	15	9	53	10 / 320 pcs
SC-SC0376	SC-SC0400	10 mm	38	21	13	22	15	10	53	10 / 320 pcs
SC-SC0377	SC-SC0401	11 mm	38	20	13	22	17	11	50	10 / 320 pcs
SC-SC0378	SC-SC0402	12 mm	38	21	13	21	18	12	52	10 / 320 pcs
SC-SC0379	SC-SC0403	13 mm	37	22	13	21	18	13	53	10 / 320 pcs
SC-SC0380	SC-SC0404	14 mm	38	22	13	23	25	14	53	10 / 320 pcs
SC-SC0381	SC-SC0405	15 mm	38	22	13	20	21	15	53	10 / 320 pcs
SC-SC0382	SC-SC0406	16 mm	37	22	13	20	21	16	54	10 / 320 pcs
SC-SC0383	SC-SC0407	17 mm	37	22	13	21	23	17	63	10 / 320 pcs
SC-SC0384	SC-SC0408	18 mm	37	22	13	22	25	18	76	10 / 200 pcs
SC-SC0385	SC-SC0409	19 mm	38	22	13	22	25	19	77	10 / 200 pcs
SC-SC0386	SC-SC0410	20 mm	37	22	13	23	27	20	77	10 / 200 pcs
SC-SC0387	SC-SC0411	21 mm	37	22	13	23	27	21	74	10 / 200 pcs
SC-SC0388	SC-SC0412	22 mm	40	22	13	25	29	22	99	10 / 200 pcs
SC-SC0389	SC-SC0413	23 mm	40	23	13	28	32	23	114	10 / 200 pcs
SC-SC0390	SC-SC0414	24 mm	40	23	13	27	31	24	118	5 / 160 pcs
SC-SC0391	SC-SC0415	25 mm	40	23	13	28	30	25	129	5 / 100 pcs
SC-SC0392	SC-SC0416	26 mm	42	25	13	29	35	26	154	5 / 100 pcs
SC-SC0393	SC-SC0417	27 mm	42	26	13	29	35	27	166	12 / 120 pcs
SC-SC0394	SC-SC0418	28 mm	43	28	13	33	37	28	170	5 / 100 pcs
SC-SC0395	SC-SC0419	29 mm	42	27	13	33	37	29	189	5 / 100 pcs
SC-SC0396	SC-SC0420	30 mm	44	30	13	33	39	30	198	5 / 80 pcs
SC-SC0397	SC-SC0421	32 mm	44	29	13	35	41	32	223	5 / 80 pcs

- Chrome vanadium material
- Drop Forged for greater strength
- Anti-rust finishing, greater strength and with knurling design for extra grip
- Silver matt finish
- Stress relief design

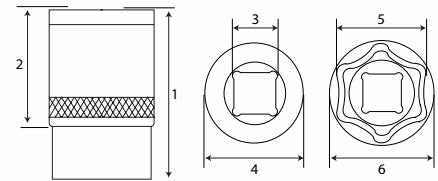

3/4" DR. HAND SOCKET 6 PT / 12 PT

3/4" DR. KUNCI SOCK 6 PT / 12 PT

ITEM CODE		SIZE	1 (mm)	2 (mm)	3 (mm)	4 (mm)	5 (mm)	6 (mm)	WEIGHT (gr)	QTY / BOX INNER/MASTER
6 PT	12 PT									
SC-SC0422	SC-SC0442	19 mm	49	29	19	35	29	19	213	5 / 75 pcs
SC-SC0423	SC-SC0443	21 mm	49	30	19	36	32	21	218	5 / 75 pcs
SC-SC0424	SC-SC0444	22 mm	49	30	19	36	32	22	213	5 / 75 pcs
SC-SC0425	SC-SC0445	23 mm	49	30	19	35	33	23	220	5 / 75 pcs
SC-SC0426	SC-SC0446	24 mm	49	30	19	36	34	24	221	5 / 75 pcs
SC-SC0427	SC-SC0447	26 mm	50	30	19	35	36	26	227	5 / 75 pcs
SC-SC0428	SC-SC0448	27 mm	51	32	19	35	37	27	227	5 / 75 pcs
SC-SC0429	SC-SC0449	28 mm	51	32	19	37	38	28	240	4 / 60 pcs
SC-SC0430	SC-SC0450	29 mm	51	31	19	37	39	29	244	4 / 60 pcs
SC-SC0431	SC-SC0451	30 mm	53	53	19	37	41	30	284	4 / 60 pcs
SC-SC0432	SC-SC0452	32 mm	56	36	19	38	43	32	307	4 / 60 pcs
SC-SC0433	SC-SC0453	33 mm	55	34	19	38	46	33	337	4 / 60 pcs
SC-SC0434	SC-SC0454	34 mm	57	37	19	38	47	34	357	4 / 60 pcs
SC-SC0435	SC-SC0455	36 mm	58	34	19	42	50	36	439	3 / 36 pcs
SC-SC0436	SC-SC0456	38 mm	59	39	19	45	52	38	486	3 / 36 pcs
SC-SC0437	SC-SC0457	41 mm	63	39	19	45	56	41	576	3 / 36 pcs
SC-SC0438	SC-SC0458	46 mm	67	44	19	48	61	46	712	2 / 20 pcs
SC-SC0439	SC-SC0459	50 mm	72	46	19	47	67	50	863	2 / 20 pcs
SC-SC0440	SC-SC0460	55 mm	72	47	19	48	67	55	1,034	1 / 20 pcs
SC-SC0441	SC-SC0461	60 mm	78	52	19	48	81	60	1,245	1 / 20 pcs

- Chrome vanadium material
- Drop Forged for greater strength
- Anti-rust finishing, greater strength and with knurling design for extra grip
- Silver matt finish
- Stress relief design

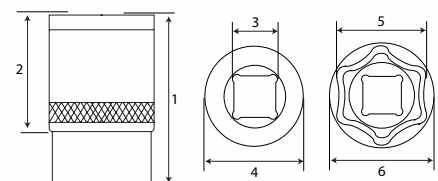

WRENCH

TORQUE

SOCKET

IMPACT SOCKET

PLIER

SCREWDRIVER

- Chrome vanadium material
- Anti-rust finishing, greater strength and with knurling design for extra grip
- Silver matt finish
- Can open 6 different type of fasteners

1/2" DR. SPLINE SOCKET

1/2" DR. KUNCI SOCK SPLINE

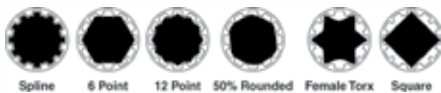

ITEM CODE	SIZE	1 (mm)	2 (mm)	3 (mm)	4 (mm)	5 (mm)	6 (mm)	WEIGHT (gr)	QTY / BOX
SC-SP0462	8 mm	38	17	7	22	13	13	46	10 / 320 pcs
SC-SP0463	9 mm	38	17	7	22	13	14	47	10 / 320 pcs
SC-SP0464	10 mm	38	17	7	22	13	16	46	10 / 320 pcs
SC-SP0465	11 mm	38	17	7	22	13	17	49	10 / 320 pcs
SC-SP0466	12 mm	38	17	7	22	13	18	49	10 / 320 pcs
SC-SP0467	13 mm	38	17	7	22	13	19	50	10 / 320 pcs
SC-SP0468	14 mm	38	17	7	22	13	21	51	10 / 320 pcs
SC-SP0469	15 mm	38	20	7	21	13	22	50	10 / 320 pcs
SC-SP0470	16 mm	38	20	7	22	13	24	59	10 / 320 pcs
SC-SP0471	17 mm	38	20	7	22	13	24	59	10 / 320 pcs
SC-SP0472	18 mm	38	21	7	23	13	26	62	10 / 200 pcs
SC-SP0473	19 mm	38	21	7	23	13	26	66	10 / 200 pcs
SC-SP0474	20 mm	38	21	7	26	13	30	75	10 / 200 pcs
SC-SP0475	21 mm	38	21	7	26	13	30	84	10 / 200 pcs
SC-SP0476	22 mm	38	21	7	26	13	30	89	10 / 200 pcs
SC-SP0477	23 mm	38	21	7	28	13	32	94	10 / 200 pcs
SC-SP0478	24 mm	38	21	7	28	13	32	99	5 / 160 pcs
SC-SP0479	25 mm	40	24	7	30	13	34	126	5 / 100 pcs
SC-SP0480	26 mm	42	26	7	30	13	36	131	5 / 100 pcs
SC-SP0481	27 mm	42	26	7	30	13	36	135	5 / 120 pcs
SC-SP0482	28 mm	44	28	7	33	13	38	159	5 / 100 pcs
SC-SP0483	29 mm	44	28	7	33	13	38	169	5 / 100 pcs
SC-SP0484	30 mm	44	28	7	34	13	40	177	5 / 80 pcs
SC-SP0485	32 mm	44	28	7	36	13	42	195	5 / 80 pcs

TYPE	4.0 mm	4.5 mm	5.0 mm	5.5 mm	6.0 mm	7.0 mm	8.0 mm	9.0 mm	10.0 mm	11.0 mm	12.0 mm	13.0 mm	14.0 mm	15 mm	16.0 mm	17.0 mm	18.0 mm	19.0 mm	20.0 mm	21.0 mm	22.0 mm	24.0 mm	27.0 mm	30.0 mm	32.0 mm
	5/32		3/16			9/32	5/16	11/32	3/8	7/16	15/32	1/2	9/16	19/32	5/8			3/4	25/32		7/8	5/16	1 1/16	1 5/32	1 1/4

- Chrome vanadium material
- Drop Forged for greater strength
- Anti-rust finishing, greater strength and with knurling design for extra grip
- Silver matt finish
- Deep-length sockets reach into wells and accomodate the excess threads of longer shafts
- Stress relief design

1/2" DR. DEEP WALL SOCKET 6 PT / 12 PT

1/2" DR. KUNCI SOCK DEEPWALL 6 PT / 12 PT

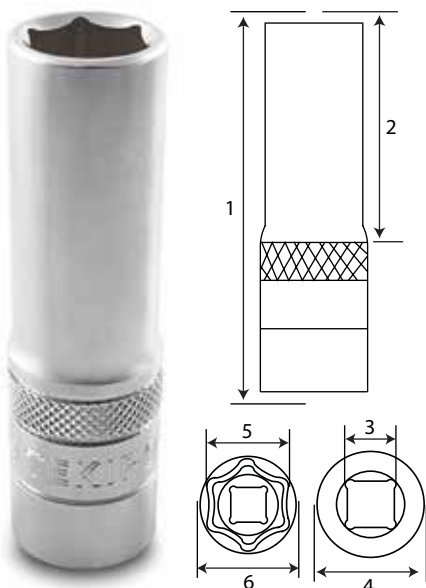

ITEM CODE		SIZE	1 (mm)	2 (mm)	3 (mm)	4 (mm)	5 (mm)	6 (mm)	WEIGHT (gr)	QTY / BOX INNER/MASTER
6 PT	12 PT									
SC-DW0486	SC-DW0509	8 mm	77	34	13	22	13	8	88	10 / 100 pcs
SC-DW0487	SC-DW0510	9 mm	77	33	13	21	14	9	84	10 / 100 pcs
SC-DW0488	SC-DW0511	10 mm	77	33	13	22	15	10	90	10 / 100 pcs
SC-DW0489	SC-DW0512	11 mm	77	32	13	22	16	11	90	10 / 100 pcs
SC-DW0490	SC-DW0513	12 mm	76	34	13	21	17	12	100	10 / 100 pcs
SC-DW0491	SC-DW0514	13 mm	77	32	13	21	18	13	105	10 / 100 pcs
SC-DW0492	SC-DW0515	14 mm	77	47	13	20	21	14	107	10 / 100 pcs
SC-DW0493	SC-DW0516	15 mm	78	47	13	20	22	15	112	10 / 100 pcs
SC-DW0494	SC-DW0517	16 mm	77	47	13	20	21	16	117	10 / 100 pcs
SC-DW0495	SC-DW0518	17 mm	77	47	13	21	23	17	126	5 / 50 pcs
SC-DW0496	SC-DW0519	18 mm	77	47	13	23	25	18	137	5 / 50 pcs
SC-DW0497	SC-DW0520	19 mm	77	47	13	23	25	18	157	5 / 50 pcs
SC-DW0498	SC-DW0521	20 mm	77	49	13	24	27	20	167	5 / 50 pcs
SC-DW0499	SC-DW0522	21 mm	77	47	13	25	27	21	176	5 / 50 pcs
SC-DW0500	SC-DW0523	22 mm	77	46	13	25	29	22	187	5 / 50 pcs
SC-DW0501	SC-DW0524	23 mm	77	47	13	27	31	23	210	5 / 50 pcs
SC-DW0502	SC-DW0525	24 mm	77	47	13	27	31	24	221	5 / 50 pcs
SC-DW0503	SC-DW0526	26 mm	77	48	13	33	35	26	281	5 / 50 pcs
SC-DW0504	SC-DW0527	27 mm	77	48	13	33	36	27	292	2 / 50 pcs
SC-DW0505	SC-DW0528	28 mm	77	47	13	34	38	28	315	2 / 50 pcs
SC-DW0506	SC-DW0529	29 mm	77	48	13	35	37	29	325	2 / 50 pcs
SC-DW0507	SC-DW0530	30 mm	77	47	13	36	39	30	360	2 / 50 pcs
SC-DW0508	SC-DW0531	32 mm	77	47	13	38	41	32	395	2 / 50 pcs

THIN DEEP SOCKET WITH GREEN FINISHING

1/2" DR. KUNCI SOCK DEEP IMPACT RODA HIJAU 6 PT

ITEM CODE	SIZE	1 (mm)	2 (mm)	3 (mm)	4 (mm)	5 (mm)	WEIGHT (gr)	QTY / BOX
SC-SD0544	19 mm	85	26	13	26	19	234	10 / 60 pcs
SC-SD0545	21 mm	85	26	13	28	21	254	10 / 60 pcs

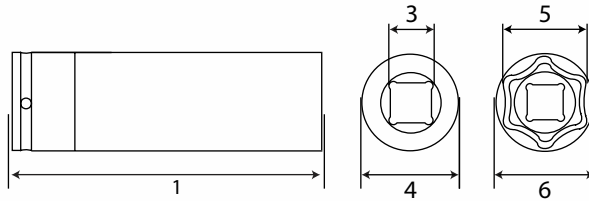

- Chrome molybdenum material
- Green Chrome plated finish for extra rust resistance, greater strength
- Durable outer sleeve and insert protects high polished wheels and lug nuts from damage
- Stress relief design

SPARK PLUG

KUNCI BUSI

ITEM CODE	SIZE	1 (mm)	2 (mm)	3 (mm)	4 (mm)	5 (mm)	WEIGHT (gr)	QTY / BOX
SC-SA0538	3/8" X 19 mm	65	31	19	25	19	121	10 / 120 pcs
SC-SA0539	3/8" X 21 mm	65	33	20	27	21	130	10 / 120 pcs
SC-SA0540	1/2" X 21 mm	65	37	23	27	21	141	10 / 120 pcs
SC-SA0541	1/2" X 16 mm	65	37	22	22	16	94	12 / 120 pcs

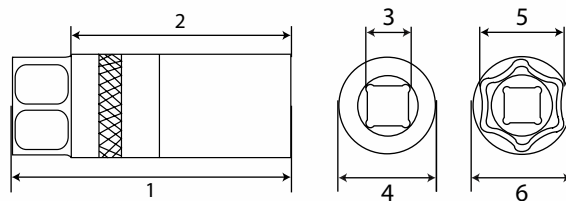

- Chrome vanadium material
- Drop Forged for greater strength
- Anti-rust finishing, greater strength and with knurling design for extra grip
- Silver matt finish
- Deep-length sockets reach into spark plugs
- Rubber retaining ring grips the spark plugs tightly during removal
- Stress relief design

1/2" DR. SPARK PLUG WITH MAGNET

1/2" DR. KUNCI BUSI MAGNET

ITEM CODE	SIZE	1 (mm)	2 (mm)	3 (mm)	4 (mm)	5 (mm)	6 (mm)	WEIGHT (gr)	QTY / BOX INNER/MASTER
SC-SA1607	3/8" x 16 mm	65	38	10	22	22	16	136	1 / 100
SC-SA1608	3/8" x 18 mm	65	46	10	20	25	18	157	1 / 100
SC-SA1609	3/8" x 21 mm	65	45	10	23	27	21	208	1 / 100
SC-SA0546	1/2" x 16 mm	65	38	13	22	22	16	98	12 / 144
SC-SA0547	1/2" x 18 mm	65	46	13	20	25	18	135	12 / 144
SC-SA0548	1/2" x 21 mm	65	45	13	23	27	21	141	12 / 144

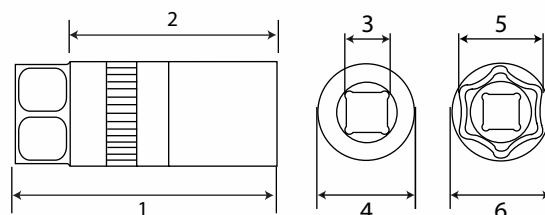

- Material is Chrome vanadium steel
- Anti-rusting, greater strength and with knurling design for extra grip with oily finger
- With magnet inside
- Silver matt finish
- Stress relief design

- Material is Chrome vanadium steel
- Heat-treated for strength and corrosion-resistance
- Green Chrome plated finish that's easy to Wipe clean
- Stress relief design



SPARK PLUG GREEN

MATA SOCK BUSI (HIJAU)

ITEM CODE	SIZE	1 (mm)	2 (mm)	3 (mm)	4 (mm)	5 (mm)	6 (mm)	WEIGHT (gr)	QTY / BOX INNER/MASTER
SC-SA0542	3/8" X 21 mm	68	52	13	20	27	21	143	10 / 120 pcs
SC-SA0543	1/2" X 21 mm	68	50	14	23	27	21	146	10 / 120 pcs

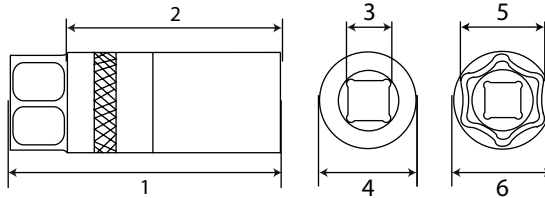

- Material is Chrome vanadium steel
- Anti-rust finishing
- Silver matt finish
- Stress relief design



1/2" DR. HEX BIT SOCKET LONG TYPE

1/2" DR. KUNCI SOCK L

ITEM CODE	SIZE	1 (mm)	2 (mm)	3 (mm)	WEIGHT (gr)	QTY / BOX INNER/MASTER
SC-HB0532	4 X 100 mm	61	13	21	84	5 / 100 pcs
SC-HB0533	5 X 100 mm	61	13	21	85	5 / 100 pcs
SC-HB0534	6 X 100 mm	61	13	21	86	5 / 100 pcs
SC-HB0535	8 X 100 mm	61	13	21	88	5 / 100 pcs
SC-HB0536	10 X 100 mm	61	13	21	110	5 / 100 pcs
SC-HB0537	12 X 100 mm	61	13	21	144	5 / 100 pcs
SC-HB1870	6 X 150 mm	110	13	22	111	6 / 120 pcs

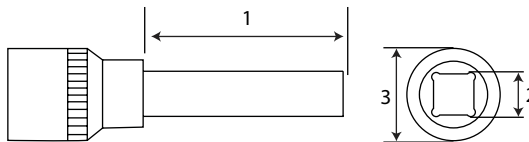

- Material is Chrome vanadium steel
- Anti-rust finishing
- Silver matt finish
- Stress relief design



1/2" DR. SPLINE SOCKET BIT

1/2" DR. KUNCI SOCK L SPLINE

ITEM CODE	SIZE	1 (mm)	2 (mm)	3 (mm)	WEIGHT (gr)	QTY / BOX INNER/MASTER
SC-SS0640	9.5 X 100 mm	100	13	21	104	12 / 144
SC-SS0641	9.5 X 140 mm	140	13	21	131	12 / 144

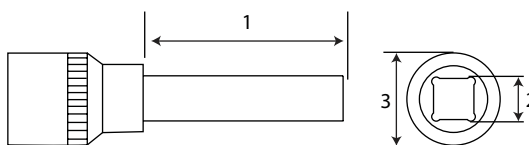

ADAPTOR

- Material is Chrome vanadium steel
- Anti-rust finishing
- Silver matt finish

ADAPTOR

ITEM CODE	SIZE	1 (mm)	2 (mm)	3 (mm)	4 (mm)	WEIGHT (gr)	QTY / BOX INNER/MASTER
SC-AD1487	3/8 F X 1/4 M	76	24	17	55	21	1 / 180 pcs
SC-AD0549	3/8 F X 1/2 M	35	15	10	17	45	30 / 180 pcs
SC-AD0550	1/2 F X 3/8 M	35	11	13	21	47	30 / 180 pcs
SC-AD0551	3/4 F X 1/2 M	54	15	19	37	230	20 / 100 pcs
SC-AD0552	1/2 F X 3/4 M	46	21	13	25	124	20 / 100 pcs

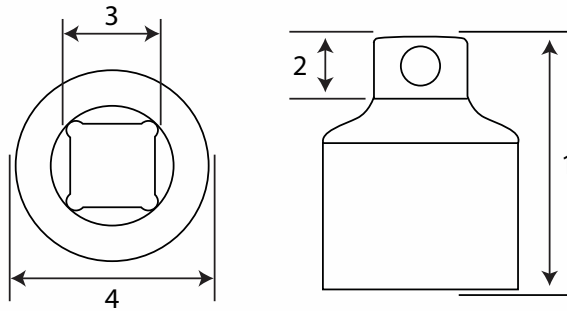

UNIVERSAL JOINT

- Material is Chrome vanadium steel
- Anti-rust finishing
- Silver matt finish

UNIVERSAL JOINT

ITEM CODE	SIZE	1 (mm)	2 (mm)	3 (mm)	4 (mm)	5 (mm)	WEIGHT (gr)	QTY / BOX INNER/MASTER
SC-UJ0553	1/4"	54	29	9	6	18	60	10 / 50 pcs
SC-UJ0554	3/8"	54	30	9	10	17	61	12 / 192 pcs
SC-UJ0555	1/2"	72	39	12	13	24	154	12 / 96 pcs

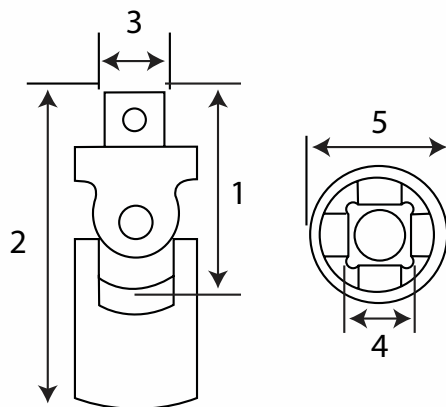

WRENCH

TORQUE

SOCKET

IMPACT SOCKET

PLIER

SCREWDRIVER





WRENCH

TORQUE

SOCKET

IMPACT SOCKET

PLIER

SCREWDRIVER

RATCHET HANDLE

Features a strong twin pawl gear mechanism that uses a different pawl for each direction of travel. This means that each is ideally positioned to take the greatest possible load, making it almost impossible to overload. Tekiro ratchet wrenches are available in various design and sizes to meet the demand of every professional user. It has 1/4", 3/8" & 1/2" drives in 24, 72 and 90 tooth design to cater for different needs and working condition.

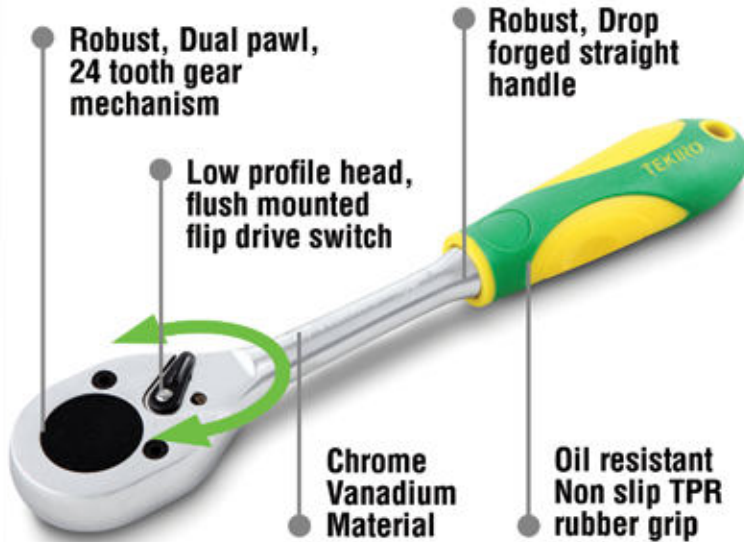

RATCHET HANDLE - QUICK RELEASE

The quick release mechanism securely locks and removes sockets easily. It also features a 72 & 90 tooth gear mechanism with 5 degree swing arc to turn fastener in tight confines.



RATCHET HANDLE

RATCHET HANDLE

ITEM CODE	SIZE	1 (mm)	2 (mm)	3 (mm)	4 (mm)	5 (mm)	WEIGHT (gr)	QTY / BOX INNER/MASTER
SC-RH0556	1/4" X 5.5"	141	74	10	6	13	148	1 / 50 pcs
SC-RH0557	3/8" X 8"	199	83	12	9	15	321	6 / 48 pcs
SC-RH0558	1/2" X 10"	251	100	14	12	21	601	6 / 24 pcs

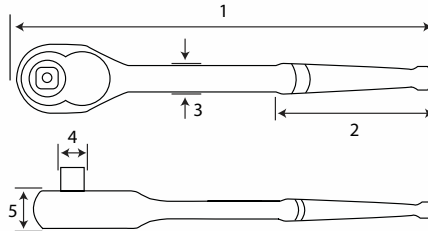

- Material is Chrome vanadium steel
- Sleek and simple handle design offers comfort and control in a variety of hand positions
- Quick-release drive tang locks securely on to sockets so they won't accidentally fall off
- Gear head design features 72-tooth mechanism for efficiency, strength and durability
- Teardrop low profile head



1/2" DR. RATCHET HANDLE 10" GREEN YELLOW (SM)

1/2" DR. RATCHET HANDLE HIJAU KUNING (SM)

ITEM CODE	SIZE	1 (mm)	2 (mm)	3 (mm)	4 (mm)	5 (mm)	6 (mm)	WEIGHT (gr)	QTY / BOX INNER/MASTER
SC-RH0559	1/2" X 10"	250	110	45	15	12	17	513	6 / 24 pcs

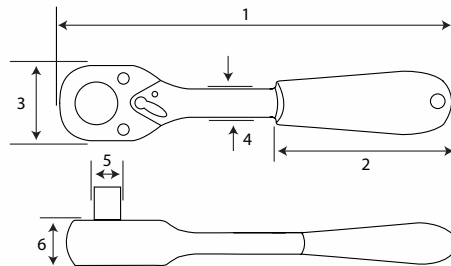

- Material is Chrome vanadium steel
- With TPR rubber grip
- 24 tooth gear Mechanism
- Straight Handle



RATCHET HANDLE (RUBBER HANDLE)

RATCHET HANDLE GAGANG KARET

ITEM CODE	SIZE	1 (mm)	2 (mm)	3 (mm)	4 (mm)	5 (mm)	6 (mm)	WEIGHT (gr)	QTY / BOX INNER/MASTER
SC-RH0560	1/4" X 5.5"	138	74	26	11	5	12	122	8 / 48 pcs
SC-RH0561	3/8" X 8"	200	109	31	13	17	9	240	6 / 48 pcs
SC-RH0562	1/2" X 10"	250	110	45	15	12	17	513	6 / 24 pcs

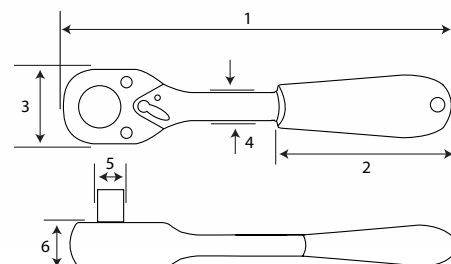

- Material is Chrome vanadium steel
- With TPR rubber grip
- Gear head design features 90-tooth mechanism with 5 degree arc swing
- 15 degree offset handle
- Quick release button



WRENCH

TORQUE

SOCKET

IMPACT SOCKET

PLIER

SCREWDRIVER

- Material is Chrome vanadium steel
- Sleek and simple handle design offers comfort and control in a variety of hand positions
- Knurled on the handle design for extra grip with oily finger



FLEXIBLE HANDLE

GAGANG FLEKSIBLE

ITEM CODE	SIZE	1 (mm)	2 (mm)	3 (mm)	WEIGHT (gr)	QTY / BOX INNER/MASTER
SC-FH0563	1/4" X 6"	150	360	38	801	10 / 100 pcs
SC-FH0564	3/8" X 10"	250	360	38	321	5 / 50 pcs
SC-FH0565	1/2" X 15"	375	360	12	813	6 / 30 pcs
SC-FH0566	1" X 26"	650	662	71	3,720	3 / 36 pcs



- Heat treated Chrome Vanadium steel
- Drop forged for extra strength
- Silver matt finishing
- Material Chrome vanadium
- Can quick turning or strong tightening



SLIDING T BAR

GAGANG SOCK T

ITEM CODE	SIZE	1 (mm)	2 (mm)	3 (mm)	4 (mm)	WEIGHT (gr)	QTY / BOX INNER/MASTER
SC-ST0567	1/4" X4"	100	5	13	6	44	20 / 100 pcs
SC-ST0568	3/8" X8"	200	10	18	19	167	12 / 48 pcs
SC-ST0569	1/2" X 10"	250	13	24	13	354	6 / 60 pcs
SC-ST0572	3/4" X 20"	500	20	37	19	1,400	5 / 10 pcs
SC-ST0573	1" X 22"	550	24	48	25	2,700	2 / 10 pcs

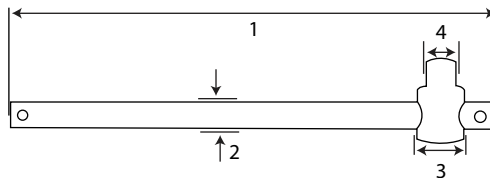

- Heat treated Chrome Vanadium steel
- Drop forged for extra strength
- Silver matt finishing

OFFSET HANDLE

GAGANG SOCK L

ITEM CODE	SIZE	1 (mm)	2 (mm)	WEIGHT (gr)	QTY / BOX INNER/MASTER
SC-OH0574	1/2" X 10"	250	16	459	12 / 48 pcs
SC-OH0575	1/2" X 12"	315	15	530	6 / 48 pcs
SC-OH0576	3/4" X 20"	500	25	2,130	5 / 10 pcs
SC-OH0577	1" X 26"	650	33	5,180	2 / 4 pcs

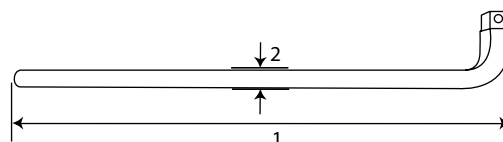

EXTENTION BAR

SAMBUNGAN SOCK

- Heat treated Chrome vanadium steel
- Drop forged for extra strength
- Fully polished finishing

ITEM CODE	SIZE	1 (mm)	2 (mm)	3 (mm)	WEIGHT (gr)	QTY / BOX BESAR
SC-EB0579	1/4" X 4"	101	8	11	44	20 / 100 pcs
SC-EB0580	1/4" X 6"	150	8	11	66	25 / 100 pcs
SC-EB0581	3/8" X 3"	75	12	17	74	10 / 120 pcs
SC-EB0582	3/8" X 6"	150	12	22	141	12 / 96 pcs
SC-EB0583	1/2" X 3"	78	17	25	117	30 / 180 pcs
SC-EB0584	1/2" X 5"	128	17	25	196	12 / 96 pcs
SC-EB0585	1/2" X 10"	250	15	22	388	12 / 48 pcs
SC-EB0586	3/4" X 4"	101	22	35	398	5 / 50 pcs
SC-EB0587	3/4" X 8"	202	22	35	720	5 / 30 pcs
SC-EB0588	3/4" X 16"	405	22	36	1,360	5 / 15 pcs
SC-EB0589	1" X 8"	200	28	48	1,322	1 / 10 pcs
SC-EB0590	1" X 16"	405	29	47	2,400	2 / 8 pcs

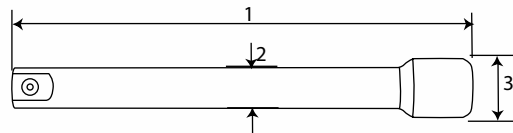

1/4" DR. HAND SOCKET SET 6 PT 4-12 MM 17 PCS

1/4" DR. KUNCI SOCK SET 4-12 MM 17 PCS

ITEM CODE	SIZE
SC-SE0591	4-12 mm (6 PT)

SIZE	CONTENT	WEIGHT (gr)	QTY / BOX INNER/MASTER
4-12 mm 6 pt	11 pcs 1/4" DR. Socket 4 mm, 4.5 mm, 5 mm, 5.5 mm 6 mm, 7 mm, 8 mm, 9 mm 10 mm, 11 mm, 12 mm	1,830	1 / 10 set
	1 pcs 1/4" DR. Ratchet Handle 5.5" Rubber Handle 72 Teeth		
	1 pcs 1/4" DR. Extension Bar 4"		
	1 pcs 1/4" Spinner Handle		
	1 pcs 1/4" DR. Sliding T Bar		
	1 pcs 1/4" DR. Universal Joint		
	1 pcs Metal Case		



WRENCH

TORQUE

SOCKET

IMPACT SOCKET

PLIER

SCREWDRIVER

3/8" DR. HAND SOCKET SET 6 PT / 12 PT 6-22 MM 18 PCS

ITEM CODE	SIZE
SC-SE0593	6-22 mm (6 PT)
SC-SE0594	6-22 mm (12 PT)



3/8" DR. KUNCI SOCK SET 6 PT / 12 PT 6-22 MM 18 PCS

SIZE	CONTENT	WEIGHT (gr)	QTY / BOX INNER/MASTER
6 - 22 mm (6 / 12 PT)	11 pcs 3/8" DR. Hand Socket 6 mm, 8 mm, 10 mm, 11 mm 12 mm, 13 mm, 14 mm, 15 mm 17 mm, 19 mm, 22 mm	2,058	1 / 10 set
	1 pcs 3/8" DR. Extension Bar 3"		
	1 pcs 3/8" DR. Extension Bar 6"		
	1 pcs 3/8" DR. Ratchet Handle 8" Rubber Handle 72 Teeth		
	1 pcs 3/8" DR. Spark Plug Socket 21 mm		
	1 pcs 3/8" DR. Offset Handle 10"		
	1 pcs 3/8" DR. Universal Joint		
	1 pcs Adaptor 1/2" F X 3/8" M		

1/2" DR. HAND SOCKET SET 6 PT / 12 PT 8-24 MM 10 PCS

ITEM CODE	SIZE
SC-SE0595	8-24 mm (6 PT)
SC-SE1286	8-24 mm (12 PT)



1/2" DR. KUNCI SOCK SET 6 PT / 12 PT 8-24 MM 10 PCS

SIZE	CONTENT	WEIGHT (gr)	QTY / BOX INNER/MASTER
8 - 24 mm (6 / 12 PT)	8 pcs 1/2" DR. Hand Socket 8 mm, 9 mm, 10 mm, 12 mm 14 mm, 17 mm, 19 mm, 24 mm	1,483	1 / 12 set
	1 pcs 1/2" DR. Offset Handle 10"		
	1 pcs Adaptor 3/8" F X 1/4" M		

1/2" DR. HAND SOCKET SET 6PT/12PT 8-24 MM 17 PCS

ITEM CODE	SIZE
SC-SE0596	8-24 mm (6 PT)
SC-SE0597	8-24 mm (12 PT)



1/2" DR. KUNCI SOCK SET 6 PT / 12 PT 8-24 MM 17 PCS

SIZE	CONTENT	WEIGHT (gr)	QTY / BOX INNER/MASTER
8 - 24 mm (6 / 12 PT)	1 pcs 1/2" DR. Ratchet Handle 10" Rubber Handle 72 Teeth	3,040	1 / 8 set
	1 pcs 1/2" DR. Extension Bar 5"		
	1 pcs 1/2" Flexible Handle 15"		
	13 pcs 1/2" DR. Hand Socket 8 mm, 10 mm, 11 mm, 12 mm 13 mm, 14 mm, 15 mm, 16 mm 17 mm, 19 mm, 21 mm 22 mm, 24 mm		
	1 pcs Metal Case		

1/2" DR. HAND SOCKET SET 6 PT / 12 PT 24 PCS

1/2" DR. KUNCI SOCK SET 6 PT / 12 PT 24 PCS

SIZE	CONTENT	WEIGHT (gr)	QTY / BOX INNER/MASTER
8 - 32 mm (6 / 12 PT)	18 pcs 1/2" DR. Hand Socket 8 mm, 9 mm, 10 mm, 11 mm 12 mm, 13 mm, 14 mm, 15 mm 16 mm, 17 mm, 19 mm, 21 mm 22 mm, 23 mm, 24 mm 27 mm, 30 mm, 32 mm	5,751	1 / 4 set
	1 pcs 1/2" DR. Ratchet Handle 10"		
	1 pcs 1/2" DR. Extension Bar 5"		
	1 pcs 1/2" DR. Extension Bar 10"		
	1 pcs 1/2" DR. Flexible Handle 15"		
	1 pcs 1/2" DR. Sliding T Bar 10"		
	1 pcs 1/2" DR. Universal Joint		
	3 / 8" - 1 1 / 4" (6 / 12 PT)		
1 pcs 1/2" DR. Ratchet Handle 10"			
1 pcs 1/2" DR. Extension Bar 5"			
1 pcs 1/2" DR. Extension Bar 10"			
1 pcs 1/2" DR. Flexible Handle 15"			
1 pcs 1/2" DR. Sliding T Bar 10"			
1 pcs 1/2" DR. Universal Joint			

ITEM CODE	SIZE
SC-SE0598	8-32 mm (6 PT)
SC-SE0599	8-32 mm (12 PT)
SC-SE0600	3/8"-1 1/4" (6 PT)
SC-SE0601	3/8"-1 1/4" (12 PT)



1/4"-3/8" DR. HAND SOCKET SET 6 PT 21 PCS

1/4"-3/8" DR. KUNCI SOCK SET 6PT 21 PCS

SIZE	CONTENT	WEIGHT (gr)	QTY / BOX INNER/MASTER
4 - 19 mm (6 PT)	7 pcs 1/4" DR. Hand Socket 4 mm, 4.5 mm, 5 mm 6 mm, 7 mm, 8 mm, 9 mm	1,513	1 / 12 set
	1 pcs 1/4" Spanner Handle		
	7 pcs 3/8" DR. Hand Socket 10 mm, 11 mm, 12 mm, 13 mm 14 mm, 17 mm, 19 mm		
	1 pcs 3/8" DR. Ratchet Handle 8" Rubber Handle 72 Teeth		
	1 pcs 3/8" DR. Spark Plug 21 mm		
	2 pcs 3/8" DR. Extension Bar 3", 6"		
	1 pcs Adaptor 3/8" F x 1/4" M		
	1 pcs Metal Case		

ITEM CODE	SIZE
SC-SE0625	1/4"-3/8" 21 PCS 6 PT



WRENCH

TORQUE

SOCKET

IMPACT SOCKET

PLIER

SCREWDRIVER

3/4" DR. HAND SOCKET SET 6 PT / 12 PT 19-50 MM 18 PCS

3/4" DR. KUNCI SOCK SET 6PT/12PT 19-50 MM 18 PCS

ITEM CODE	SIZE
SC-SE0602	19-50 mm (6 PT)
SC-SE0603	19-50 mm (12 PT)



SIZE	CONTENT	WEIGHT (gr)	QTY / BOX INNER/MASTER
19 - 50 mm (6 / 12 PT)	13 pcs 3/4" DR. Hand Socket	12,666	1 set
	19 mm, 21 mm, 22 mm, 23 mm, 24 mm		
	27 mm, 30 mm, 32 mm, 36 mm, 38 mm		
	41 mm, 46 mm, 50 mm		
	1 pcs 3/4" DR. Ratchet Handle 20"		
	1 pcs 3/4" DR. Extension Bar 4"		
	1 pcs 3/4" DR. Extension Bar 8"		
	1 pcs 3/4" DR. Sliding T Bar 20"		
1 pcs	Metal Case		

1/2" DR. HAND SOCKET SET 6 PT / 12 PT 8-24 MM 10 PCS BMC

1/2" DR. KUNCI SOCK SET 6 PT / 12 PT 8-24 MM (TB PLASTIK) 10 PCS

ITEM CODE	SIZE
SC-SE0604	8-24 mm (6 PT)
SC-SE0605	8-24 mm (12 PT)



SIZE	CONTENT	WEIGHT (gr)	QTY / BOX INNER/MASTER
8 - 24 mm (6 / 12 PT)	8 pcs 1/2" DR. Hand Socket	1,483	1 / 12 set
	8 mm, 9 mm, 10 mm, 12 mm		
	14 mm, 17 mm, 19 mm, 24 mm		
	1 pcs 1/2" DR. Offset Handle 10"		
1 pcs	Adaptor 3/8" X 1/4" M		

1/2" DR. HAND SOCKET SET 6PT/12PT 8-24 MM 17 PCS BMC

KUNCI SOCK SET 1/2" DR 6 PT/12 PT 17 PCS (PLASTIK)

ITEM CODE	SIZE
SC-SE0606	8-24 mm (6 PT)
SC-SE0607	8-24 mm (12 PT)



SIZE	CONTENT	WEIGHT (gr)	QTY / BOX INNER/MASTER
8 - 24 mm (6 / 12 PT)	13 pcs 1/2" DR. Hand Socket	2,850	1 / 8 set
	8 mm, 10 mm, 11 mm, 12 mm		
	13 mm, 14 mm, 15 mm, 16 mm		
	17 mm, 19 mm, 21 mm		
	22 mm, 24 mm		
	1 pcs 1/2" DR. Ratchet Handle 10"		
	Rubber Handle 72 Teeth		
	1 pcs 1/2" DR. Extension Bar 5"		
	1 pcs 1/2" DR. Flexible Handle 15"		
	1 pcs		

3/8" DR. HAND SOCKET SET 6 PT / 12 PT 6-22 MM 18 PCS

3/8" DR. KUNCI SOCK SET 6PT/12PT 6-22 MM (TB PLASTIK) 18 PCS

SIZE	CONTENT	WEIGHT (gr)	QTY / BOX INNER/MASTER
6 - 22 mm (6 / 12 PT)	11 pcs 3/8" DR. Hand Socket 6 mm, 8 mm, 10 mm, 11 mm, 12 mm, 13 mm 14 mm, 15 mm, 17 mm, 19 mm, 22 mm	1,970	1 / 10 set
	1 pcs 3/8" DR. Extension Bar 3"		
	1 pcs 3/8" DR. Extension Bar 6"		
	1 pcs 3/8" DR. Ratchet Handle 8" Rubber Handle 72 Teeth		
	1 pcs 3/8" DR. Spark Plug 21 mm		
	1 pcs 3/8" DR. Offset handle 10"		
	1 pcs 3/8" DR. Universal Joint		
	1 pcs Adaptor 1/2" F x 3/8" M		

1/4"- 3/8" DR. HAND SOCKET SET 6 PT 4-19 MM 21 PCS BMC

1/4"-3/8" DR. KUNCI SOCK SET 6PT (TB PLASTIK) 21 PCS

SIZE	CONTENT	WEIGHT (gr)	QTY / BOX INNER/MASTER
21 pcs (6 PT)	7 pcs 1/4" DR. Hand Socket 4 mm, 4.5 mm, 5 mm, 6 mm, 7 mm, 8 mm, 9 mm	1,364	1 / 12 set
	1 pcs 1/4" Spanner Handle		
	7 pcs 3/8" DR. Hand Socket 10 mm, 11 mm, 12 mm, 13 mm, 14 mm 17 mm, 19 mm		
	2 pcs 3/8" DR. Extension Bar 3", 6"		
	1 pcs 3/8" DR. Ratchet Handle 8" Rubber Handle 72 Teeth		
	1 pcs 3/8" DR. Spark Plug Socket 21 MM		
	1 pcs Adaptor 3/8" F x 1/4" M		
	1 pcs Blow Mould Case		

1/2" DR. HAND SOCKET SET 6 PT / 12 PT 10-32 MM 22 PCS

1/2" DR. KUNCI SOCK SET 6 PT / 12 PT 10-32 MM (TB PLASTIK) 22 PCS

SIZE	CONTENT	WEIGHT (gr)	QTY / BOX INNER/MASTER
10 - 32 mm (6 / 12 PT)	15 pcs 1/2" DR. Hand Socket 10 mm, 11 mm, 12 mm, 13 mm 14 mm, 15 mm, 16 mm, 17 mm 18 mm, 19 mm, 22 mm, 24 mm 27 mm, 30 mm, 32 mm	3,611	1 / 5 set
	1 pcs 1/2" DR. Ratchet Handle 10" Rubber Handle 72 Teeth		
	1 pcs 1/2" DR. Universal Joint		
	1 pcs 1/2" DR. Extension Bar 5"		
	1 pcs 1/2" DR. Extension Bar 10"		
	1 pcs 1/2" DR. Spark Plug Socket 16 mm		
	1 pcs 1/2" DR. Spark Plug Socket 21 mm		
	1 pcs Adaptor 3/8" F x 1/2" M		

ITEM CODE	SIZE
SC-SE0608	8-22 mm (6 PT)
SC-SE0609	8-22 mm (12 PT)



ITEM CODE	SIZE
SC-SE0610	4-19 mm (6 PT)



ITEM CODE	SIZE
SC-SE0611	10-32 mm (6 PT)
SC-SE0612	10-32 mm (12 PT)



WRENCH

TORQUE

SOCKET

IMPACT SOCKET

PLIER

SCREWDRIVER



1/2" DR. HAND SOCKET SET 6 PT / 12 PT 24 PCS

ITEM CODE	SIZE
SC-SE0613	8-32 mm (6 PT)
SC-SE0614	3/8"-1 1/4" (6PT)
SC-SE0615	8-32 mm (12 PT)
SC-SE0616	3/8"-1 1/4" (12 PT)



KUNCI SOCK SET 1/2" DR 6 PT/12 PT 24 PCS (PLASTIK)

SIZE	CONTENT	WEIGHT (gr)	QTY / BOX INNER/MASTER
8 - 32 mm (6 / 12 PT)	18 pcs 1/2" DR. Hand Socket 8 mm, 9 mm, 10 mm, 11 mm 12 mm, 13 mm, 14 mm, 15 mm 16 mm, 17 mm, 19 mm, 21 mm 22 mm, 23 mm, 24 mm, 27 mm 30 mm, 32 mm	5,280	1 / 4 set
	1 pcs 1/2" DR. Ratchet Handle 10" Rubber Handle 72 Teeth		
	1 pcs 1/2" DR. Universal Joint		
	1 pcs 1/2" DR. Extension Bar 5"		
	1 pcs 1/2" DR. Extension Bar 10"		
	1 pcs 1/2" DR. Flexible Handle 15"		
	1 pcs 1/2" DR. Sliding T Bar 10"		
3/8" - 1 1/4" (6 / 12 PT)	18 pcs 1/2" DR. Hand Socket 3/8", 7/16", 1/2", 9/16", 19/32" 5/8", 11/16", 3/4", 25/32", 13/16" 7/8", 15/16", 31/32", 1", 1 - 1/16" 1 - 1/8", 1 - 3/16", 1 - 1/4"		
	1 pcs 1/2" DR. Ratchet Handle 10" Rubber Handle 72 Teeth		
	1 pcs 1/2" DR. Universal Joint		
	1 pcs 1/2" DR. Extension Bar 5"		
	1 pcs 1/2" DR. Extension Bar 10"		
	1 pcs 1/2" DR. Flexible Handle 15"		
	1 pcs 1/2" DR. Sliding T Bar 10"		

3/8" DR. HAND SOCKET SET 6 PT 6-24 MM 26 PCS

ITEM CODE	SIZE
SC-SE0617	6-24 mm (6 PT)



3/8" DR. KUNCI SOCK SET 6 PT 6-24 MM (TB PLASTIK) 26 PCS

SIZE	CONTENT	WEIGHT (gr)	QTY / BOX INNER/MASTER
6 - 24 mm (6 PT)	18 pcs 3/8" DR. Hand Socket 6 mm, 7 mm, 8 mm, 9 mm, 10 mm 11 mm, 12 mm, 13 mm, 14 mm, 15 mm 16 mm, 17 mm, 18 mm, 19 mm, 20 mm 21 mm, 22 mm, 24 mm	2,373	1 / 5 set
	1 pcs 3/8" DR. Ratchet Handle 8" Rubber Handle 72 Teeth		
	1 pcs 3/8" DR. Universal Joint		
	1 pcs 3/8" DR. Extension Bar 2"		
	1 pcs 3/8" DR. Extension Bar 3"		
	1 pcs 3/8" DR. Extension Bar 6"		
	1 pcs 3/8" DR. Spark Plug Socket 16 mm		
	1 pcs 3/8" DR. Spark Plug Socket 21 mm		
	1 pcs Adaptor 1/2" F x 3/8" M		

1/2" DR. HAND SOCKET SET 6 PT 8-32 MM 32 PCS

1/2" DR. KUNCI SOCK SET 6 PT 8-32 MM (TB PLASTIK) 32 PCS

SIZE	CONTENT	WEIGHT (gr)	QTY / BOX INNER/MASTER
8 - 32 mm (6PT)	19 pcs 1/2" DR. Hand Socket 6 PT 8 mm, 9 mm, 10 mm, 11 mm, 12 mm 13 mm, 14 mm, 15 mm, 16 mm, 17 mm 18 mm, 19 mm, 20 mm, 21 mm, 22 mm 24 mm, 27 mm, 30 mm, 32 mm	4,173	1 / 5 set
	6 pcs 1/2" DR. Hand Socket 12 PT 10 mm, 12 mm, 14 mm, 15 mm, 17 mm, 19 mm		
	1 pcs 1/2" DR. Ratchet Handle 10" Rubber Handle 72 Teeth		
	1 pcs 1/2" DR. Universal Joint		
	1 pcs 1/2" DR. Extension Bar 5"		
	1 pcs 1/2" DR. Extension Bar 10"		
	1 pcs 1/2" DR. Spark Plug Socket 16 mm		
	1 pcs 1/2" DR. Spark Plug Socket 21 mm		
	1 pcs Adaptor 3/8" F x 1/2" M		

ITEM CODE	SIZE
SC-SE0618	8-32 mm (6 PT)



1/4" DR. HAND SOCKET SET 6 PT 41 PCS

1/4" DR. KUNCI SOCK SET 6 PT (TB PLASTIK) 41 PCS

SIZE	CONTENT	WEIGHT (gr)	QTY / BOX INNER/MASTER
4 - 14 mm (6 PT)	13 pcs 1/4" DR. Hand Socket 4 mm, 4.5 mm, 5 mm, 5.5 mm, 6 mm 7 mm, 8 mm, 9 mm, 10 mm, 11 mm 12 mm, 13 mm, 14 mm	1,147	1 / 10 set
	6 pcs 1/4" DR. Hex Bits Socket 25 MM H3, H4, H5, H6, H8, H10		
	6 pcs 1/4" DR. Torque Bits Socket 25 MM T10, T15, T20, T25, T30, T40		
	3 pcs 1/4" DR. Pozi Bits Socket 25 MM PZ1, PZ2, PZ3		
	3 pcs 1/4" DR. Philips Bits Socket 25 MM PH1, PH2, PH3		
	3 pcs 1/4" DR. Slotted Bits Socket 25 MM SL4, SL5, SL6		
	1 pcs 1/4" DR. Ratchet Handle 5.5" Rubber Handle 72 Teeth		
	1 pcs 1/4" DR. Universal Joint		
	1 pcs 1/4" DR. Spinner Handle		
	1 pcs 1/4" DR. Extension Bar 2"		
	1 pcs 1/4" DR. Extension Bar 4"		
	1 pcs 1/4" DR. Extension Bar 6"		
	1 pcs 1/4" DR. Bit Adaptor		

ITEM CODE	SIZE
SC-SE0619	4-14 mm (6 PT)



WRENCH

TORQUE

SOCKET

IMPACT SOCKET

PLIER

SCREWDRIVER

1/4" DR. HAND SOCKET SET 6 PT 46 PCS

1/4" DR. KUNCI SOCK SET 6 PT (TB PLASTIK) 46 PCS

ITEM CODE	SIZE
SC-SE0620	4-14 mm (6 PT)

SIZE	CONTENT	WEIGHT (gr)	QTY / BOX INNER/MASTER
4 - 14 mm (6 PT)	13 pcs 1/4" DR. Hand Socket 4 mm, 4.5 mm, 5 mm, 5.5 mm, 6 mm 7 mm, 8 mm, 9 mm, 10 mm, 11 mm 12 mm, 13 mm, 14 mm	1,404	1 / 10 set
	6 pcs 1/4" DR. Hex Bits Socket 37 mm H3, H4, H5, H6, H7, H8		
	6 pcs 1/4" DR. Torque Bits Socket 37 mm T10, T15, T20, T25, T30, T40		
	3 pcs 1/4" DR. Pozi Bits Socket 37 mm PZ1, PZ2, PZ3		
	3 pcs 1/4" DR. Philips Bits Socket 37 mm PH1, PH2, PH3		
	3 pcs 1/4" DR. Slotted Bits Socket 37 mm SL4, SL5, SL6		
	4 pcs Hex Key 1.27 mm, 1.5 mm, 2 mm, 2.5 mm		
	1 pcs 1/4" DR. Ratchet Handle 5.5" Rubber Handle 72 Teeth		
	1 pcs 1/4" DR. Universal Joint		
	1 pcs 1/4" DR. Spinner Handle (SM)		
	1 pcs 1/4" DR. Extension Bar 2"		
	1 pcs 1/4" DR. Extension Bar 4"		
	1 pcs 1/4" DR. Sliding T Handle 4"		
	1 pcs 1/4" DR. Flexible Handle 6" (SM)		
	1 pcs 1/4" x 1/4" Hex Adaptor		



3/8" DR. HAND SOCKET SET 6 PT 58 PCS

3/8" DR. KUNCI SOCK SET 6 PT (TB PLASTIK) 58 PCS

ITEM CODE	SIZE
SC-SE0621	6-24 mm (6 PT)

SIZE	CONTENT	WEIGHT (gr)	QTY / BOX INNER/MASTER
6 - 24 mm (6 PT)	18 pcs 3/8" DR. Hand Socket 6 mm, 7 mm, 8 mm, 9 mm, 10 mm 11 mm, 12 mm, 13 mm, 14 mm, 15 mm 16 mm, 17 mm, 18 mm, 19 mm, 20 mm 21 mm, 22 mm, 24 mm	3,993	1 / 5 set
	9 pcs 3/8" DR. Deep Wall Socket 6PT 8 mm, 10 mm, 11 mm, 12 mm, 13 mm 14 mm, 15 mm, 17 mm, 19 mm		
	7 pcs 3/8" DR. Hex Bits Socket 50 mm H3, H4, H5, H6, H7, H8, H10		
	9 pcs 3/8" DR. Torque Bits Socket 50 mm T10, T15, T20, T25, T30, T40, T45, T50, T55		
	3 pcs 3/8" DR. Pozi Bits Socket 50 mm PZ1, PZ2, PZ3		
	2 pcs 3/8" DR. Philips Bits Socket 50 mm PH1, PH2		
	3 pcs 3/8" DR. Slotted Bits Socket 50 mm SL4, SL5.5, SL7		
	1 pcs 3/8" DR. Ratchet Handle 8" Rubber Handle 72 Teeth		
	1 pcs 3/8" DR. Universal Joint		
	1 pcs 3/8" DR. Extension Bar 3"		
	1 pcs 3/8" DR. Extension Bar 10"		
	1 pcs 3/8" DR. Spark Plug Socket 16 mm		
	1 pcs 3/8" DR. Spark Plug Socket 21 mm		
	1 pcs Adaptor 1 / 2" F x 3 / 8" M		



WRENCH

TORQUE

SOCKET

IMPACT SOCKET

PLIER

SCREWDRIVER

1/4"-1/2" DR. HAND SOCKET SET 6 PT 94 PCS

1/4"-1/2" DR. KUNCI SOCK SET 6 PT (TB PLASTIK) 94 PCS

SIZE	CONTENT	WEIGHT (gr)	QTY / BOX INNER/MASTER
94 pcs (6 PT)	18 pcs 1/2" DR. Hand Socket 6 PT 10 mm, 11 mm, 12 mm, 13 mm, 14 mm 15 mm, 16 mm, 17 mm, 18 mm, 19 mm 20 mm, 21 mm, 22 mm, 23 mm, 24 mm 27 mm, 30 mm, 32 mm	5,914	1 / 4 set
	4 pcs 1/2" DR. Deep Wall Socket 6 PT 14 mm, 15 mm, 17 mm, 19 mm		
	1 pcs 1/2" DR. Ratchet Handle 10" Rubber Handle 72 Teeth		
	1 pcs 1/2" DR. Universal Joint		
	1 pcs 1/2" DR. Extension Bar 5"		
	1 pcs 1/2" DR. Extension Bar 10"		
	1 pcs 1/2" DR. Spark Plug 16 mm (SM)		
	1 pcs 1/2" DR. Spark Plug 21 mm (SM)		
	1 pcs Adaptor 3/8" F x 1/2" M		
	1 pcs 1/2" DR. Hexagon Bits Coupler 8 mm		
	13 pcs 1/4" DR. Hand Socket 6 PT 4 mm, 4.5 mm, 5 mm, 5.5 mm 6 mm, 7 mm, 8 mm, 9 mm, 10 mm 11 mm, 12 mm, 13 mm, 14 mm		
	8 pcs 1/4" DR. Deep Wall Socket 6 PT 6 mm, 7 mm, 8 mm, 9 mm, 10 mm 11 mm, 12 mm, 13 mm		
	1 pcs 1/4" DR. Ratchet Handle 5.5"		
	1 pcs 1/4" DR. Universal Joint		
	1 pcs 1/4" DR. Extension Bar 2"		
	1 pcs 1/4" DR. Extension Bar 4"		
	1 pcs Go - Thru Spinner Handle		
	1 pcs 1/4" DR. Flexible Spinner Handle		
	1 pcs 1/4" DR. Sliding T Bar 4"		
	4 pcs 1/4" DR. Hex Bits Socket 37 mm H3, H4, H5, H6		
	3 pcs 1/4" DR. Slotted Bits Socket 37 mm SL4, SL5.5, SL7		
	6 pcs 1/4" DR. Torque Bits Socket 37 mm T8, T10, T15, T20, T25, T30		
	2 pcs 1/4" DR. Pozi Bits Socket 37 mm PZ1, PZ2		
	4 pcs 5/16" DR. Hex Bits Socket 30 MM H8, H10, H12, H14		
	4 pcs 5/16" DR. Torque Bits Socket 30 MM T40, T45, T50, T55		
	2 pcs 5/16" DR. Pozi Bits Socket 30 MM PZ3, PZ4		
	2 pcs 5/16" DR. Philips Bit Socket 30 MM PH3, PH4		
	2 pcs 1/4" DR. Philips Bit Socket 37 MM PH1, PH2		
	3 pcs 5/16" DR. Slotted Bit Socket 30 MM SL8, SL10, SL12		
	3 pcs Hex Key Long 1.5 mm, 2 mm, 2.5 mm		
	1 pcs 1/4" Hex Adaptor		

ITEM CODE	SIZE
SC-SE0622	94 PCS (6PT)



WRENCH

TORQUE

SOCKET

IMPACT SOCKET

PLIER

SCREWDRIVER

1/4"-3/8"-1/2" DR. HAND SOCKET SET 6 PT / 12 PT 120 PCS

1/4"-3/8"-1/2" DR. KUNCI SOCK SET 6 PT / 12 PT (TB PLASTIK) 120 PCS

SIZE	CONTENT	WEIGHT (gr)	QTY / BOX INNER/MASTER
120 pcs (6 / 12 PT)	11 pcs 1/2" DR. Hand Socket 20 mm, 21 mm, 22 mm, 24 mm 27 mm, 30 mm, 32 mm 15 / 16", 1", 1 - 1 / 16", 1 - 1 / 4"	9,391	1 / 2 set
	20 pcs 1/4" DR. Hand Socket 4 mm, 5 mm, 6 mm, 7 mm, 8 mm 9 mm, 10 mm, 11 mm, 12 mm, 13 mm 5 / 32", 3 / 16", 7 / 32", 1 / 4", 9 / 32", 5 / 16" 11 / 32", 3 / 8", 7 / 16", 1 / 2"		
	20 pcs 3/8" DR. Hand Socket 9 mm, 10 mm, 11 mm, 12 mm, 13 mm 14 mm, 15 mm, 16 mm, 17 mm, 18 mm, 19 mm 3 / 8", 7 / 16", 1 / 2", 9 / 16", 5 / 8", 11 / 16" 3 / 4", 13 / 16", 7 / 8"		
	10 pcs Combination Wrench 8 mm, 9 mm, 10 mm, 11 mm, 12 mm 13 mm, 14 mm, 17 mm, 18 mm, 19 mm		
	4 pcs 1/2" DR. Impact Socket 17 mm, 19 mm, 21 mm, 23 mm		
	4 pcs 1/4" DR. Deep Wall Socket 8 mm, 9 mm, 10 mm, 12 mm		
	4 pcs 3/8" DR. Deep Wall Socket 13 mm, 14 mm, 15 mm, 17 mm		
	8 pcs 3/8" Star Socket E8, E10, E11, E12, E14, E16, E18, E20		
	3 pcs Universal Joint 1/2", 1/4", 3/8"		
	2 pcs 3/8" DR. Spark Plug 16 mm, 21 mm		
	2 pcs 1/2" DR. Extension Bar 5", 10"		
	2 pcs 3/8" DR. Extension Bar 3" dan 6"		
	1 pcs 1/4" DR. Extension Bar 2"		
	1 pcs 1/4" DR. Spinner Handle		
	1 pcs 1/4" DR. Hex Adaptor		
	1 pcs 1/2" DR. Ratchet Handle 10" Rubber Handle 72 Teeth		
	1 pcs 1/4" DR. Ratchet Handle 5.5" Rubber Handle 72 Teeth		
	1 pcs 3/8" DR. Ratchet Handle 8" Rubber Handle 72 Teeth		
	4 pcs 3/8" DR. Hex Bit Socket 50 mm H3, H4, H5, H6		
	7 pcs 1/4" DR. Torque Bit Socket 25 mm T10, T15, T20, T25, T27, T30, T40		
	7 pcs 3/8" DR. Torque Bit Socket 50 mm T20, T30, T40, T45, T50, T55, T60		
	2 pcs 3/8" DR. Pozi Bit Socket 50 mm PZ1, PZ2		
	2 pcs 3/8" DR. Philips Bit Socket 50 mm PH1, PH2		
	2 pcs 3/8" DR. Slotted Bit Socket 50 mm SL5.5, SL6.5		

ITEM CODE	SIZE
SC-SE1383	120 PCS (6 PT)
SC-SE1384	120 PCS (12 PT)

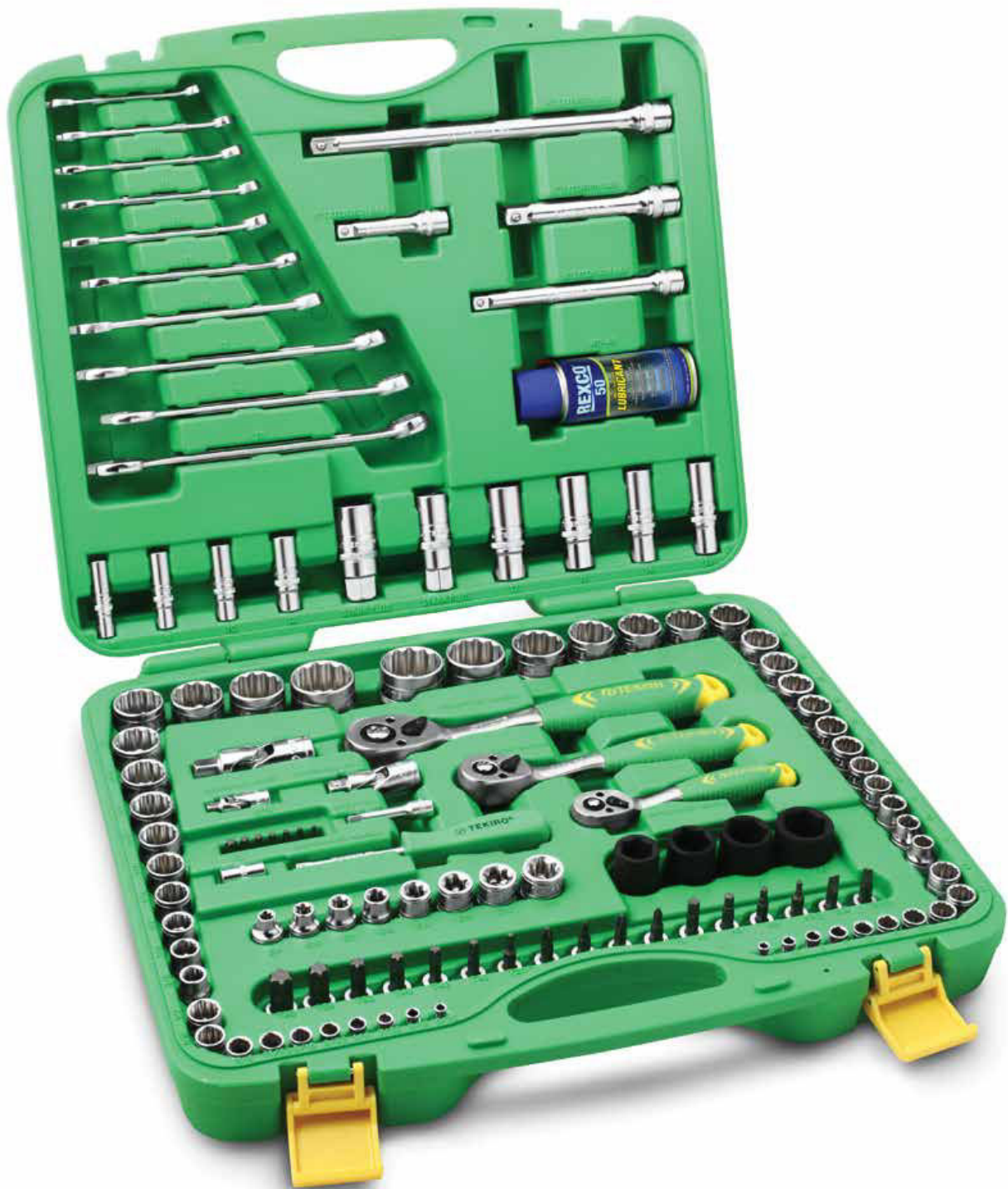

WRENCH

TORQUE

SOCKET

IMPACT SOCKET

PLIER

SCREWDRIVER



1/2" DR. STAR SOCKET SET E10-E24 9 PCS

1/2" DR. KUNCI SOCK BINTANG SET 9 PCS

ITEM CODE	TYPE	CONTENT	WEIGHT (gr)	QTY / BOX INNER/MASTER
SC - SA0634	4093	9 pcs 1/2" DR. Star Socket E10, E11, E12, E14, E16 E18, E20, E22, E24	1,060	1 / 10 set



1/2" DR. STAR SOCKET BIT SET T20-T60 9 PCS

1/2" DR. KUNCI SOCK L BINTANG SET 9 PCS (SM)

ITEM CODE	TYPE	CONTENT	WEIGHT (gr)	QTY / BOX INNER/MASTER
SC-SB0636	4102	9 pcs 1/2" DR. Starbit Socket T20, T25, T27, T30, T40, T45 T50, T55, T60	1,010	1 / 10 set



1/2" DR. STAR BIT SOCKET SET T30-T70 16 PCS

1/2" DR. KUNCI SOCK BINTANG & L BINTANG SET 16 PCS

ITEM CODE	TYPE	CONTENT	WEIGHT (gr)	QTY / BOX INNER/MASTER
SC-SB0637	4171	9 pcs 1/2" DR. Star Socket E10, E11, E12, E14, E16 E18, E20, E22, E24	1,741	1 / 10 set
		7 pcs 1/2" DR. Starbit Socket T30, T40, T45, T50, T55, T60, T70		



1/2" DR. HEX BIT SOCKET SET 10 PCS

1/2" DR. KUNCI SOCK L SET 10 PCS (SM)

ITEM CODE	TYPE	CONTENT	WEIGHT (gr)	QTY / BOX INNER/MASTER
SC-HB0638	4111	7 pcs 1/2" DR. Hex Bit Socket 55 mm H4, H5, H6, H7, H8, H10, H12	1,582	1 / 10 set
		1 pcs 1/2" DR. Hex Bit Socket 65 mm H14		
		2 pcs 1/2" DR. Hex Bit Socket 70 mm H17, H19		

1/2" DR. SOCKET CHEST SET 6 PT / 12 PT 137 PCS COMPLETE WITH THE SOCKET

1/2" DR. KUNCI SOCK SET 6PT/12PT 137 PCS DENGAN DISPLAY BOX BESI

SIZE	CONTENT	WEIGHT (gr)	QTY / BOX INNER/MASTER
8 - 32 mm (6 / 12 PT)	10 pcs 8 mm	3,611	1 set
	10 pcs 9 mm		
	10 pcs 10 mm		
	10 pcs 11 mm		
	10 pcs 12 mm		
	10 pcs 13 mm		
	10 pcs 14 mm		
	10 pcs 15 mm		
	10 pcs 16 mm		
	9 pcs 17 mm		
	9 pcs 19 mm		
	8 pcs 21 mm		
	8 pcs 22 mm		
	3 pcs 23 mm		
	4 pcs 24 mm		
	2 pcs 27 mm		
	2 pcs 30 mm		
	2 pcs 32 mm		

ITEM CODE	SIZE
SC-CH0639	8-32 mm (6 PT)
SC-CH1285	8-32 mm (12 PT)



1/2" DR. BIT SET 42 PCS

1/2" DR. BIT SET 42 PCS

TYPE	CONTENT	WEIGHT (gr)	QTY / BOX INNER/MASTER
4421	8 pcs Star Bit 30 mm T20, T25, T30, T40, T45, T50, T55, T60	2,139	1 / 10 set
	8 pcs Star Bit 75 mm T20, T25, T30, T40, T45, T50, T55, T60		
	6 pcs Hex Bit 30 mm 4, 5, 6, 7, 8, 10, 12		
	6 pcs Hex Bit 75 mm 4, 5, 6, 7, 8, 10, 12		
	5 pcs Spline Bit 30 mm M5, M6, M8, M10, M12		
	5 pcs Spline Bit 75 mm M5, M6, M8, M10, M12		
	1 pcs 3/8" DR. Bits Holder 10mm		
	1 pcs 1/2" DR. Bits Holder 10mm		

ITEM CODE	SIZE
SC-BS0635	4421



WRENCH

TORQUE

SOCKET

IMPACT SOCKET

PLIER

SCREWDRIVER

- Material is Chrome vanadium steel socket
- Anti-rust finishing
- Knurling on the ring design for extra grip with oily finger
- Silver matt finish

1/2" DR. STAR BIT SOCKET

1/2" DR. KUNCI SOCK L BINTANG

ITEM CODE	SIZE	1 (mm)	2 (mm)	3 (mm)	4 (mm)	5 (mm)	WEIGHT (gr)	QTY / BOX INNER/MASTER
SC-SB1657	T 40	55	21	6	14	21.0	65.5	10 / 300 pcs
SC-SB1658	T 45	55	21	7	16	21.0	68.0	10 / 300 pcs
SC-SB1659	T 50	55	22	8	16	21.0	68.5	30 / 300 pcs

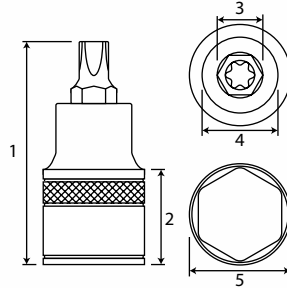

- Material is Chrome vanadium steel
- Anti-rust finishing, greater strength and with knurling design for extra grip with oily finger ~ with rubber inside
- Silver matt finish

3/8" DR. SPARK PLUG WITH RUBBER INSIDE

3/8" DR. KUNCI BUSI KARET

ITEM CODE	SIZE	1 (mm)	2 (mm)	3 (mm)	4 (mm)	5 (mm)	WEIGHT (gr)	QTY / BOX INNER/MASTER
SC-SP1673	14 mm	63	9	16	19	14.0	71.5	10 / 120 pcs

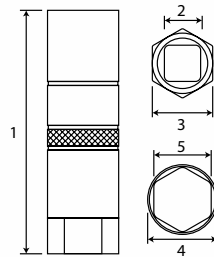

- High torque
- Multiple bit
- High durable hardness
- CR-V is used for bit material

INSERT RATCHET SCREWDRIVER 9 PCS BITS

OBENG KETOK SET 11 PCS

ITEM CODE	CONTENT	1 (mm)	2 (mm)	3 (mm)	WEIGHT (gr)	QTY / BOX INNER/MASTER
SC-IR1610	1 pcs Ratchet Screwdriver Handle	96	16	8	15,200	60 / 120 pcs
	2 pcs Single Head Bits Philips PH1, PH3					
	1 pcs Single Head Bits Slotted SL6					
	5 pcs Single Head Bits Hex H2.5, H3, H4, H5, H6					

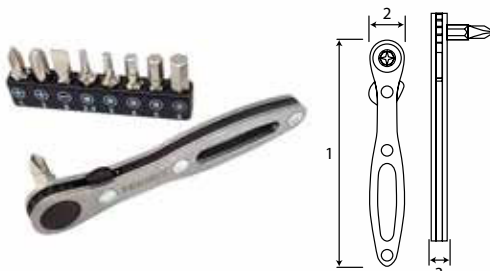



IMPACT SOCKET

Tersedia di :  **QHOME MART**

TEKIRO IMPACT SOCKETS

- Two different lengths selection (Standard & Deep).
- The deep type are of a thin wall design that can be used in confined spaces.
- In addition to the usual engraved stamp, the large easy-to-read size indication is displayed.

SPECIFICATION

TEKIRO impact sockets are manufactured from the highest quality material using the latest technique, and exceeds international standards.



3/8" DR. IMPACT SOCKET 6 PT

3/8" DR. KUNCI SOCK IMPACT 6 PT

ITEM CODE	SIZE	1 (mm)	2 (mm)	3 (mm)	WEIGHT (gr)	QTY / BOX INNER/MASTER
IS-IS1600	17 mm	24	32	22	83,5	300 pcs
IS-IS1601	19 mm	27	30	20	70	150 pcs
IS-IS1602	22 mm	31	32	22	87	150 pcs

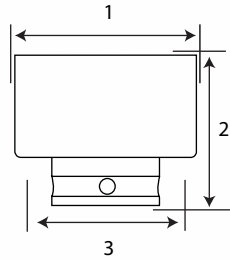

- Material is Chrome molybdenum steel with proper heat treatment for extra durability and strength
- Manganese Phosphate coating to help resist corrosion and ensure an extra life time of use



1/2" DR. IMPACT SOCKET 6 PT

1/2" DR. KUNCI SOCK IMPACT 6 PT

ITEM CODE	SIZE	1 (mm)	2 (mm)	3 (mm)	WEIGHT (gr)	QTY / BOX INNER/MASTER
IS-IS0642	8 mm	15	39	24	70	10 pcs
IS-IS0643	9 mm	16	39	25	70	10 pcs
IS-IS0644	10 mm	18	39	25	70	10 pcs
IS-IS0645	11 mm	18	39	25	71	10 pcs
IS-IS0646	12 mm	20	38	25	74	10 pcs
IS-IS0647	13 mm	21	39	25	75	10 pcs
IS-IS0648	14 mm	22	39	30	80	10 pcs
IS-IS0649	15 mm	23	40	25	77	10 pcs
IS-IS0650	16 mm	24	39	30	117	10 pcs
IS-IS0651	17 mm	25	39	29	124	10 pcs
IS-IS0652	18 mm	26	40	31	120	10 pcs
IS-IS0653	19 mm	28	38	30	118	10 pcs
IS-IS0654	20 mm	29	39	30	123	5 pcs
IS-IS0655	21 mm	30	39	30	117	5 pcs
IS-IS0656	22 mm	31	39	29	129	5 pcs
IS-IS0657	23 mm	33	37	30	130	5 pcs
IS-IS0658	24 mm	34	50	30	136	5 pcs
IS-IS0659	25 mm	35	39	30	149	5 pcs
IS-IS0660	26 mm	36	40	30	137	5 pcs
IS-IS0661	27 mm	37	42	31	162	5 pcs
IS-IS0662	28 mm	40	45	30	187	5 pcs
IS-IS0663	29 mm	41	48	30	214	5 pcs
IS-IS0664	30 mm	41	48	30	200	5 pcs
IS-IS0665	32 mm	44	48	30	211	5 pcs

- Material is Chrome molybdenum steel with proper heat treatment for extra durability and strength
- Manganese Phosphate coating to help resist corrosion and ensure an extra life time of use

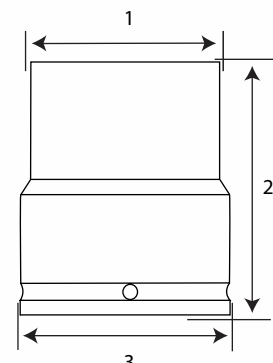

WRENCH

TORQUE

SOCKET

IMPACT SOCKET

PLIER

SCREWDRIVER

- Material is Chrome molybdenum steel with proper heat treatment for extra durability and strength
- Manganese Phosphate coating to help resist corrosion and ensure an extra life time of use

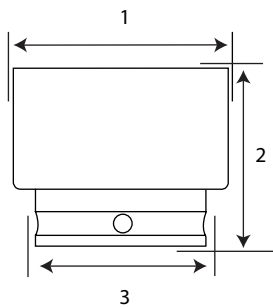

3/4" DR. IMPACT SOCKET 6 PT

3/4" DR. KUNCI SOCK IMPACT 6 PT

ITEM CODE	SIZE	1 (mm)	2 (mm)	3 (mm)	WEIGHT (gr)	QTY / BOX INNER/MASTER
IS-IS0666	17 mm	28	50	37	252	5 / 75 pcs
IS-IS0667	18 mm	29	52	37	238	5 / 75 pcs
IS-IS0668	19 mm	31	51	40	275	5 / 75 pcs
IS-IS0669	21 mm	36	49	40	300	5 / 75 pcs
IS-IS0670	22 mm	36	50	40	302	5 / 75 pcs
IS-IS0671	23 mm	36	51	40	304	4 / 60 pcs
IS-IS0672	24 mm	38	51	40	299	4 / 60 pcs
IS-IS0673	26 mm	39	51	40	308	4 / 60 pcs
IS-IS0674	27 mm	41	52	41	333	4 / 60 pcs
IS-IS0675	28 mm	43	54	43	362	4 / 60 pcs
IS-IS0676	29 mm	44	55	44	393	4 / 60 pcs
IS-IS0677	30 mm	45	54	44	405	4 / 60 pcs
IS-IS0678	32 mm	48	56	44	456	4 / 60 pcs
IS-IS0679	33 mm	50	57	44	485	4 / 60 pcs
IS-IS0680	34 mm	52	56	44	504	3 / 36 pcs
IS-IS0681	35 mm	51	56	44	472	3 / 36 pcs
IS-IS0682	36 mm	52	56	43	514	3 / 36 pcs
IS-IS0683	38 mm	55	56	43	540	3 / 36 pcs
IS-IS0684	41 mm	59	57	44	609	3 / 36 pcs
IS-IS0685	46 mm	65	62	43	749	2 / 20 pcs
IS-IS0686	50 mm	70	67	43	881	2 / 20 pcs
IS-IS0687	52 mm	75	72	54	1,130	1 / 20 pcs
IS-IS0688	54 mm	77	73	54	1,247	1 / 20 pcs
IS-IS0689	55 mm	77	74	54	1,217	1 / 24 pcs
IS-IS0690	57 mm	80	75	54	1,300	1 / 15 pcs
IS-IS0691	58 mm	82	80	54	1,350	1 / 15 pcs
IS-IS0692	59 mm	82	75	55	1,380	1 / 15 pcs
IS-IS0693	60 mm	82	80	60	1,517	1 / 15 pcs
IS-IS0694	62 mm	85	81	54	1,450	1 / 12 pcs
IS-IS0695	65 mm	89	80	55	1,500	1 / 12 pcs
IS-IS0696	70 mm	96	86	54	1,845	1 / 12 pcs

1" DR. IMPACT SOCKET 6 PT

1" DR. KUNCI SOCK IMPACT 6 PT

ITEM CODE	SIZE	1 (mm)	2 (mm)	3 (mm)	WEIGHT (gr)	QTY / BOX INNER/MASTER
IS-IS0697	30 mm	49	54	42	691	3 / 36 pcs
IS-IS0698	32 mm	50	55	42	701	3 / 36 pcs
IS-IS0699	36 mm	56	65	54	751	4 / 24 pcs
IS-IS0700	38 mm	56	65	55	781	4 / 24 pcs
IS-IS0701	41 mm	63	65	54	812	4 / 16 pcs
IS-IS0702	42 mm	62	65	54	841	2 / 20 pcs
IS-IS0703	46 mm	69	74	54	1,040	4 / 12 pcs
IS-IS0704	48 mm	68	74	54	1,077	4 / 12 pcs
IS-IS0705	50 mm	74	75	54	1,157	4 / 12 pcs
IS-IS0706	52 mm	75	70	54	1,180	1 / 20 pcs
IS-IS0707	55 mm	80	85	55	1,500	1 / 12 pcs
IS-IS0708	60 mm	92	93	54	1,740	1 / 10 pcs
IS-IS0709	65 mm	93	93	54	2,007	1 / 10 pcs
IS-IS0710	70 mm	100	99	54	2,461	1 / 10 pcs
IS-IS0711	75 mm	105	101	85	3,652	1 / 6 pcs
IS-IS0712	80 mm	111	100	85	3,780	1 / 6 pcs
IS-IS0713	85 mm	117	102	86	4,150	1 / 6 pcs
IS-IS0714	90 mm	124	107	85	4,472	1 / 5 pcs
IS-IS0715	95 mm	128	104	85	4,515	1 / 5 pcs
IS-IS0716	100 mm	137	105	95	5,320	1 / 4 pcs

- Material is Chrome molybdenum steel with proper heat treatment for extra durability and strength
- Manganese Phosphate coating to help resist corrosion and ensure an extra life time of use

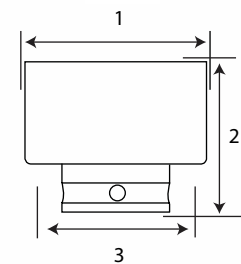

1/2" DR. DEEP IMPACT SOCKET 6 PT

1/2" DR. KUNCI SOCK DEEP IMPACT 6 PT

ITEM CODE	SIZE	1 (mm)	2 (mm)	3 (mm)	4 (mm)	5 (mm)	WEIGHT (gr)	QTY / BOX INNER/MASTER
IS-DP0717	8 mm	77	13	24	14	8	117	5 pcs
IS-DP0718	9 mm	77	13	25	16	9	117	5 pcs
IS-DP0719	10 mm	77	13	24	17	10	138	5 pcs
IS-DP0720	11 mm	78	13	25	19	11	135	5 pcs
IS-DP0721	12 mm	78	13	24	19	12	143	5 pcs
IS-DP0722	13 mm	79	13	24	21	13	152	5 pcs
IS-DP0723	14 mm	78	13	23	22	14	150	5 pcs
IS-DP0724	15 mm	78	13	24	24	15	155	5 pcs
IS-DP0725	16 mm	78	13	24	25	16	156	5 pcs
IS-DP0726	17 mm	77	13	25	25	17	196	5 pcs
IS-DP0727	18 mm	79	13	27	28	18	232	5 pcs
IS-DP0728	19 mm	78	13	28	27	19	207	5 pcs
IS-DP0729	20 mm	79	13	29	30	20	245	5 pcs
IS-DP0730	21 mm	78	13	29	29	21	238	5 pcs
IS-DP0731	22 mm	78	13	30	31	22	275	5 pcs
IS-DP0732	23 mm	78	13	30	31	23	261	5 pcs
IS-DP0733	24 mm	79	13	30	32	24	292	4 pcs
IS-DP0734	26 mm	78	13	30	35	26	285	4 pcs
IS-DP0735	27 mm	78	13	30	37	27	364	4 pcs
IS-DP0736	28 mm	78	13	30	37	28	293	4 pcs
IS-DP0737	29 mm	78	13	30	39	29	334	3 pcs
IS-DP0738	30 mm	78	13	30	42	30	457	3 pcs
IS-DP0739	32 mm	78	13	30	43	32	449	3 pcs

- Material is Chrome molybdenum steel with proper heat treatment for extra durability and strength
- Manganese Phosphate coating to help resist corrosion and ensure an extra life time of use

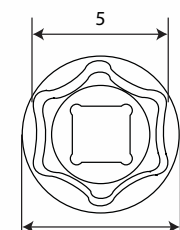
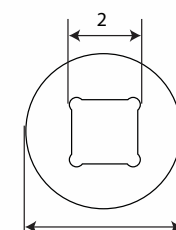
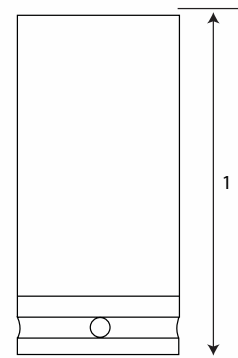

WRENCH

TORQUE

SOCKET

IMPACT SOCKET

PLIER

SCREWDRIVER



RATCHET HANDLE IMPACT

RATCHET HANDLE IMPACT

ITEM CODE	SIZE	1 (mm)	2 (mm)	3 (mm)	4 (mm)	5 (mm)	WEIGHT (gr)	QTY / BOX INNER/MASTER
IS-RH0740	3/4"	500	122	23	18	28	2.700	1 / 10 pcs
IS-RH0741	1"	665	137	28	20	33	4.650	3 / 6 pcs

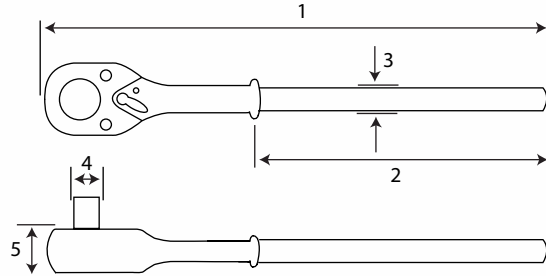

- Material is Chrome molybdenum steel with proper heat treatment for extra durability and strength
- Manganese Phosphate coating to help resist corrosion and ensure an extra life time of use
- Quick-release drive tang locks securely on to sockets so they won't accidentally fall off



IMPACT EXTENTION BAR

SAMBUNGAN SOCK IMPACT

ITEM CODE	SIZE	1 (mm)	2 (mm)	3 (mm)	WEIGHT (gr)	QTY / BOX INNER/MASTER
IS-EB0742	1/2" X 3"	78	16	12	150	1 / 120 pcs
IS-EB0743	1/2" X 5"	128	16	12	230	12 / 72 pcs
IS-EB0744	1/2" X 10"	252	16	12	430	12 / 48 pcs
IS-EB0745	3/4" X 4"	98	25	19	568	5 / 30 pcs
IS-EB0746	3/4" X 10"	254	25	19	1,173	5 / 20 pcs

- Material is Chrome molybdenum steel with proper heat treatment for extra durability and strength
- Manganese Phosphate coating to help resist corrosion and ensure an extra life time of use

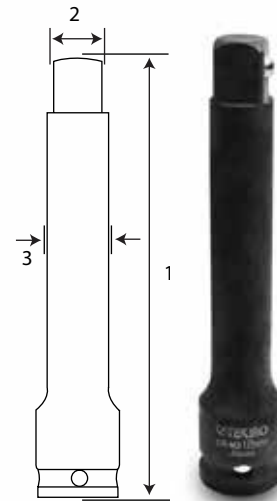

IMPACT SLIDING T BAR

GAGANG SOCK T IMPACT

ITEM CODE	SIZE	1 (mm)	2 (mm)	3 (mm)	WEIGHT (gr)	QTY / BOX INNER/MASTER
IS-SL0747	3/4" X 20"	510	20	39	1,578	5 / 10 pcs
IS-SL0756	1" X 22"	563	28	49	3,239	1 / 6 pcs

- Material is Chrome molybdenum steel with proper heat treatment for extra durability and strength
- Manganese Phosphate coating to help resist corrosion and ensure an extra life time of use
- Sliding socket head can apply more leverage and torque

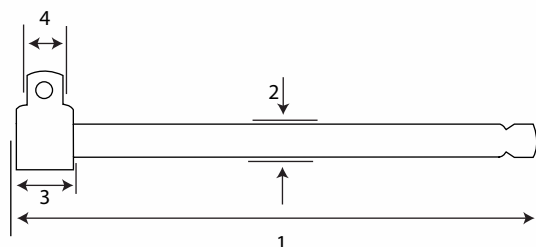

WRENCH

TORQUE

SOCKET

IMPACT SOCKET

PLIER

SCREWDRIVER

- Material is Chrome molybdenum steel with proper heat treatment for extra durability and strength
- Manganese Phosphate coating to help resist corrosion and ensure an extra life time of use
- Spring loaded ball bearing to secure the socket



IMPACT OFFSET HANDLE

GAGANG SOCK L IMPACT

ITEM CODE	SIZE	1 (mm)	2 (mm)	WEIGHT (gr)	QTY / BOX INNER/MASTER
IS-OH0748	3/4" X 20"	532	25	2,101	5 / 10 pcs
IS-OH0757	1" X 26"	690	34	5,399	1 / 4 pcs

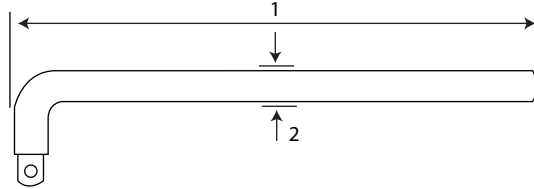

- Material is Chrome molybdenum steel with proper heat treatment for extra durability and strength
- Manganese Phosphate coating to help resist corrosion and ensure an extra life time of use
- Spring loaded ball bearing to secure the socket



IMPACT ADAPTOR

IMPACT ADAPTOR

ITEM CODE	SIZE	1 (mm)	2 (mm)	3 (mm)	4 (mm)	WEIGHT (gr)	QTY / BOX INNER/MASTER
IS-AI0749	3/8 F x 1/2 M	38	14	9	21	65	60 / 240 pcs
IS-AI0750	1/2 F x 3/8 M	35	11	13	21	51	60 / 240 pcs
IS-AI0751	1/2 F x 3/4 M	48	19	13	30	165	40 / 160 pcs
IS-AI0752	3/4 F x 1/2 M	74	22	26	53	659	12 / 48 pcs
IS-AI0753	3/4 F x 1 M	63	25	20	43	435	12 / 48 pcs
IS-AI0754	1 F x 3/4 M	75	21	26	54	658	6 / 24 pcs

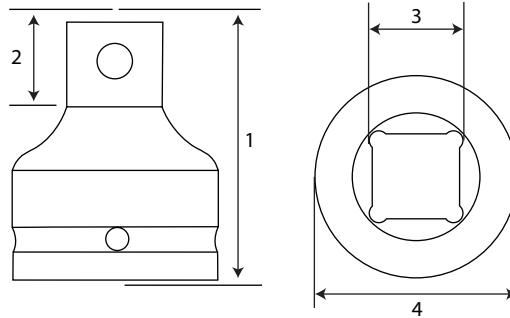

3/4" DR. IMPACT SOCKET SET 6 PT 17 PCS

3/4" DR. KUNCI SOCK IMPACT SET 6 PT 17 PCS

ITEM CODE	SIZE
IS-SE0755	21 - 50 MM (6PT)



SIZE	CONTENT	WEIGHT (gr)	QTY / BOX INNER/MASTER
21 - 50 mm (6 PT)	1 pcs 3/4" DR. Ratchet Handle 20"	16,500	1 set
	3/4" DR. Impact Extension Bar 4"		
	1 pcs 3/4" DR. Impact Extension Bar 10"		
	1 pcs 3/4" DR. Impact Sliding T Bar 20"		
	13 pcs 1/2" DR. Socket		
	21 mm, 22 mm, 23 mm, 24 mm		
	27 mm, 30 mm, 32 mm, 36 mm		
	38 mm, 41 mm, 46 mm, 50 mm		
	1 pcs Metal Case		

PLIER



Tersedia di :  **QHOME MART**



PLIERS

Pliers is a convenient tool for various purposes. Used for holding, cutting wires, and a variety of other tasks. The **TEKIRO** pliers With high-quality material and precision smooth joint make the many tasks easy to handle.



High quality carbon steel of 42-48 HRC for strength and durability

Induction hardened cutting edges of 60-65 HRC for ultimate performance

Precision machined joint for smooth action

Heavy duty comfortable TPR handle for working long period

Optimum transmission of force due to ergonomically designed handgrips



WWW.TEKIRO.COM

LINESMAN PLIERS

TANG KOMBINASI

ITEM CODE	SIZE	1 (mm)	2 (mm)	3 (mm)	4 (mm)	5 (mm)	6 (mm)	CUTTING CAPACITY	WEIGHT (gr)	QTY / BOX INNER/MASTER
PL-LM1288	4.5"	120	15	80	6	21	12	Hard Wire : 1.8 mm Soft Wire : 2.8 mm	81	6 / 60 pcs
PL-LM0758	7"	175	27	116	10	37	16	Hard Wire : 2.0 mm Soft Wire : 3.4 mm	267	6 / 60 pcs
PL-LM0759	8"	200	29	130	12	39	12	Hard Wire : 2.3 mm Soft Wire : 3.7 mm	333	6 / 60 pcs

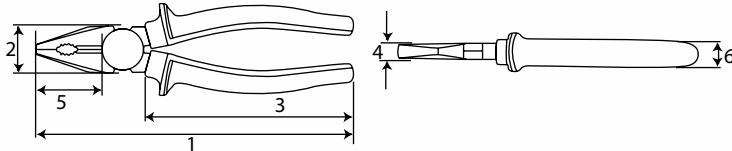

- Made of High Quality Carbon Steel
- Jaw and cutting edges induction hardened to 60-65 HRC
- Jagged jaw at the centre designed to grip round objects Hexagon nuts and a variety of shapes and sizes
- Exceeds JIS standards
- Ergonomic non slip TPR grip handle

LONG NOSE PLIERS

TANG LANCIP

ITEM CODE	SIZE	1 (mm)	2 (mm)	3 (mm)	4 (mm)	5 (mm)	6 (mm)	CUTTING CAPACITY	WEIGHT (gr)	QTY / BOX INNER/MASTER
PL-LN1289	4.5"	120	12	80	6	21	12	Hard Wire : 1.2 mm Soft Wire : 1.8 mm	77	6 / 60 pcs
PL-LN0760	6"	150	18	90	10	37	15	Hard Wire : 1.6 mm Soft Wire : 2.2 mm	163	6 / 60 pcs
PL-LN0761	8"	200	21	107	10	39	15	Hard Wire : 2.0 mm Soft Wire : 2.6 mm	240	6 / 60 pcs

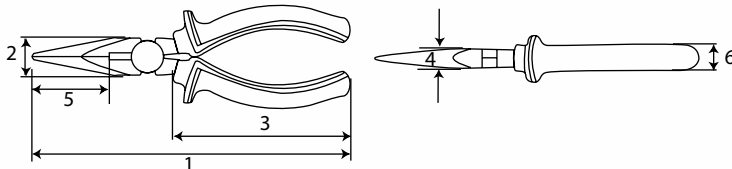

- Made of High Quality Carbon Steel
- Jaw and cutting edges induction hardened to 60-65 HRC
- Jagged jaw at the centre designed to grip round objects Hexagon nuts and a variety of shapes and sizes
- Exceeds JIS standards
- Ergonomic non slip TPR grip handle

DIAGONAL PLIERS

TANG POTONG

ITEM CODE	SIZE	1 (mm)	2 (mm)	3 (mm)	4 (mm)	5 (mm)	6 (mm)	CUTTING CAPACITY	WEIGHT (gr)	QTY / BOX INNER/MASTER
PL-DG1290	4.5"	120	11	79	6	18	12	Hard Wire : 1.6 mm Soft Wire : 2.2 mm	70	6 / 60 pcs
PL-DG0762	6"	150	20	110	10	29	15	Hard Wire : 2.0 mm Soft Wire : 2.6 mm	180	6 / 60 pcs
PL-DG0763	8"	200	23	130	10	38	15	Hard Wire : 2.2 mm Soft Wire : 2.8 mm	260	6 / 60 pcs

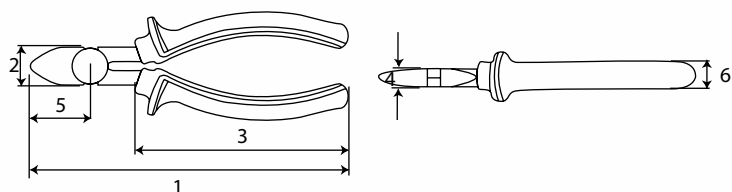

- Made of High Quality Carbon Steel
- Jaw and cutting edges induction hardened to 60-65 HRC
- Jagged jaw at the centre designed to grip round objects Hexagon nuts and a variety of shapes and sizes
- Exceeds JIS standards
- Ergonomic non slip TPR grip handle

WRENCH

TORQUE

SOCKET

IMPACT SOCKET

PLIER

SCREWDRIVER

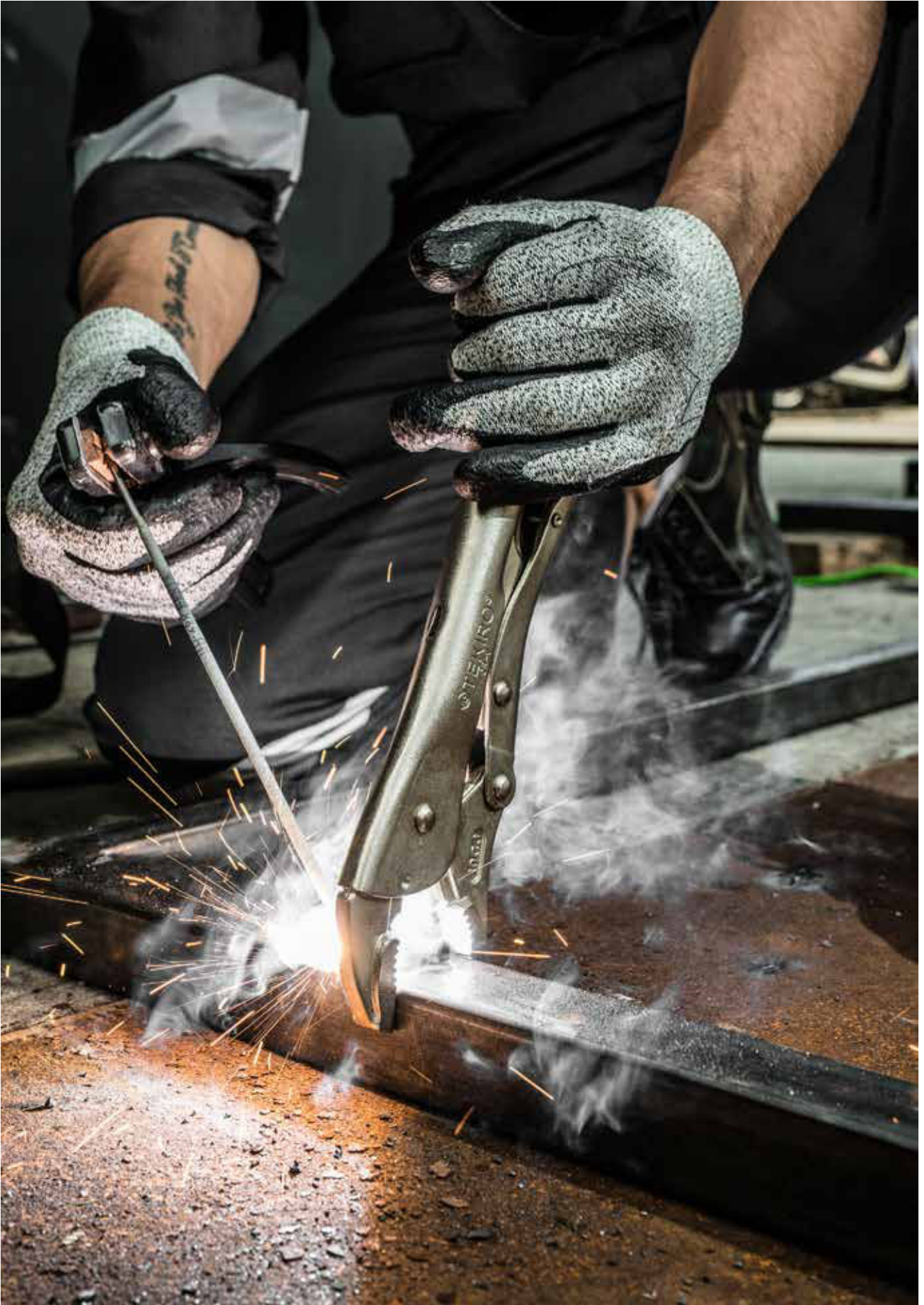

LOCKING PLIERS

TEKIRO Locking Plier Curve Jaw has a powerful locking action with wide jaw opening to clamp large round objects and same time with small enough tips to grip tiny objects. The curve jaw with hardened teeth are designed to grip a variety of shapes from any angle. The classic trigger release provides safety and security during release of the jaw from the material. Also known as a portable clamp, the clamping force could exceed 2 tons in clamping force depending of the size of the plier.



Used as a portable clamp



Curve jaw locking plier clamped onto a round pipe

WRENCH

TORQUE

SOCKET

IMPACT SOCKET

PLIER

SCREWDRIVER

- Strongest locking plier in the range
- Clamping force exceeds 2 tons on 10" plier
- Known as portable clamp
- Made of Chrome vanadium material
- Chrome Nickel plated to resist rust and corrosion

LOCKING PLIERS STRAIGHT

TANG BUAYA LURUS

ITEM CODE	SIZE	1 (mm)	2 (mm)	3 (mm)	4 (mm)	MAX. JAW OPENING (5) (mm)	WEIGHT (gr)	QTY / BOX INNER/MASTER
PL-LG0767	7"	175	54	12	28	29	330	6 / 30 pcs
PL-LG0768	10"	250	62	12	34	41	440	6 / 30 pcs

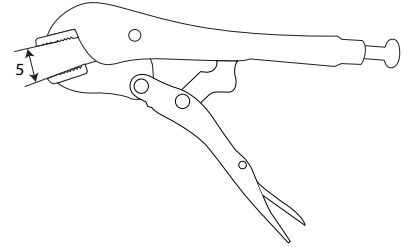
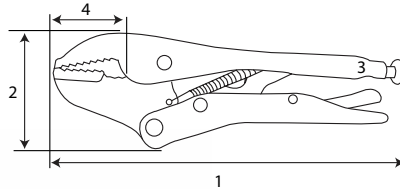

- Excellence gripping power, no slipping or stripping
- Heat treated alloy steel teeth
- Material chrome vanadium
- Knurled tip ideal for gripping small objects
- Comes with wire cutter. Cuts up to 5mm of hard wire with the compound jaw action
- Ideal for gripping and holding round objects
- Able to grip & release rusted or frozen bolts and nuts

LOCKING PLIERS CURVE

TANG BUAYA BENGKOK

ITEM CODE	SIZE	1 (mm)	2 (mm)	3 (mm)	4 (mm)	MAX. JAW OPENING (5) (mm)	WEIGHT (gr)	QTY / BOX INNER/MASTER
PL-LG0769	7"	175	54	12	30	42	330	6 / 30 pcs
PL-LG0770	10"	250	62	12	38	48	440	6 / 30 pcs

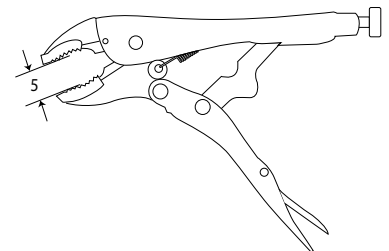
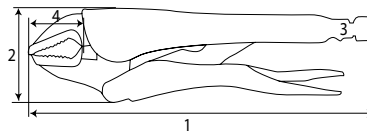

BOLT CUTTER

TEKIRO bolt cutters combine specially formulated steel jaws and precise manufacturing techniques to make various cutters handle low, high, and medium materials of all types. Extra wide rubber coated and ergonomic handle makes cutting job easy and effortless.



- Made of Chrome Vanadium Material
- Jaw hardened to cut medium to high tensile material
- Light weight tubular handle strong enough for heavy duty cutting
- Cam adjusted Jaws

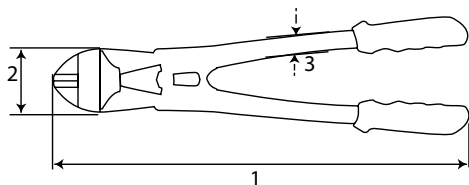

BOLT CUTTER

GUNTING BETON

ITEM CODE	SIZE	1 (mm)	2 (mm)	3 (mm)	CUTTING CAPACITY	WEIGHT (gr)	QTY / BOX INNER/MASTER
PL-BC1416	12"	300	48	17	Medium Steel : ø 4 mm Soft Steel : ø 5 mm	737	1 / 20 pcs
PL-BC1417	14"	350	61	17	Medium Steel : ø 5 mm Soft Steel : ø 6 mm	945	1 / 20 pcs
PL-BC1418	18"	450	70	19	Medium Steel : ø 6 mm Soft Steel : ø 8 mm	1,430	1 / 12 pcs
PL-BC1419	24"	600	82	21	Medium Steel : ø 8 mm Soft Steel : ø 10 mm	2,300	1 / 8 pcs
PL-BC1420	30"	750	94	26	Medium Steel : ø 10 mm Soft Steel : ø 12 mm	3,770	1 / 5 pcs
PL-BC1421	36"	900	107	27	Medium Steel : ø 12 mm Soft Steel : ø 14 mm	4,860	1 / 4 pcs
PL-BC1422	42"	1,050	122	33	Medium Steel : ø 14 mm Soft Steel : ø 16 mm	7,820	1 / 3 pcs

WRENCH

TORQUE

SOCKET

IMPACT SOCKET

PLIER

SCREWDRIVER



SNAP RING PLIERS

These pliers are often used for attaching and detaching a snap ring. Internal snap ring pliers for fitting ring in bore holes and external snap ring pliers for fitting ring on shaft.

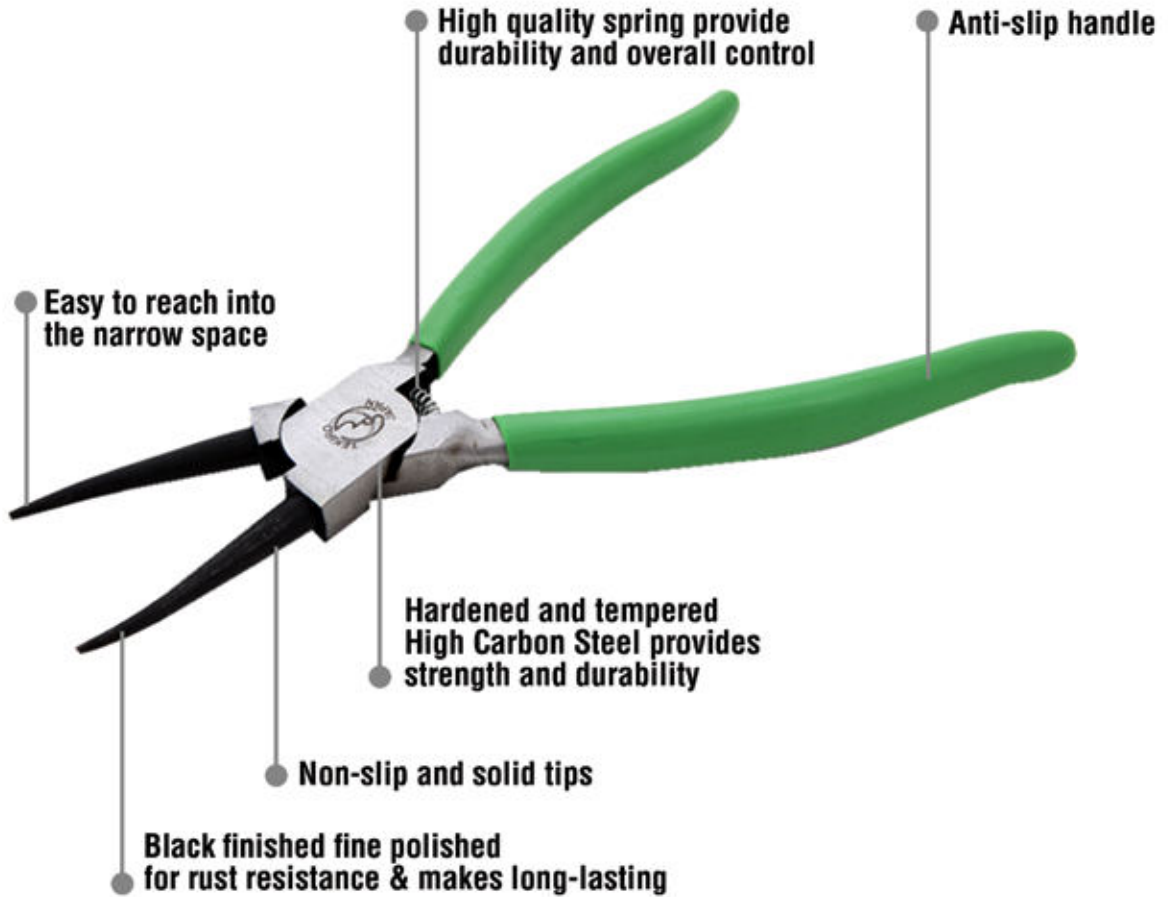

SNAP RING PLIERS EB

TANG SNAP RING - EB

ITEM CODE	SIZE	1 (mm)	2 (mm)	3 (mm)	4 (mm)	5 (mm)	6 (mm)	WEIGHT (gr)	QTY / BOX INNER/MASTER
PL-SR0771	5"	125	70	20	92	10	7	100	6 / 120 pcs
PL-SR0772	7"	175	85	26	106	10	7	175	6 / 120 pcs
PL-SR0773	9"	225	99	30	134	10	7	373	6 / 60 pcs

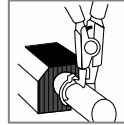
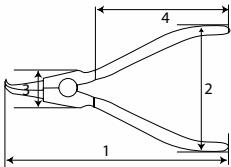

- Long life
- Ergonomic handle
- Convenient for removing / installing snap rings on master cylinders or brakes



SNAP RING PLIERS IB

TANG SNAP RING - IB

ITEM CODE	SIZE	1 (mm)	2 (mm)	3 (mm)	4 (mm)	5 (mm)	6 (mm)	WEIGHT (gr)	QTY / BOX INNER/MASTER
PL-SR0774	5"	125	65	20	78	10	7	100	6 / 120 pcs
PL-SR0775	7"	175	73	25	100	10	7	151	6 / 120 pcs
PL-SR0776	9"	225	67	26	130	10	7	272	6 / 60 pcs

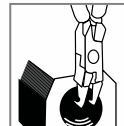
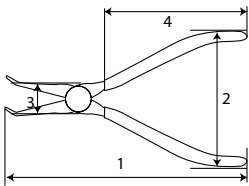

- Long life
- Ergonomic handle
- Convenient for removing / installing snap rings on master cylinders or brakes



SNAP RING PLIERS ES

TANG SNAP RING - ES

ITEM CODE	SIZE	1 (mm)	2 (mm)	3 (mm)	4 (mm)	5 (mm)	6 (mm)	7 (mm)	WEIGHT (gr)	QTY / BOX INNER/MASTER
PL-SR0777	5"	125	25	19	72	88	10	7	101	6 / 120 pcs
PL-SR0778	7"	175	25	26	92	112	10	7	175	6 / 120 pcs
PL-SR0779	9"	225	25	29	86	135	10	7	282	6 / 60 pcs

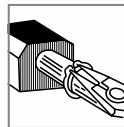
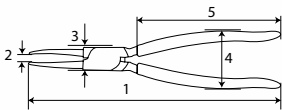

- Long life
- Ergonomic handle
- Convenient for removing / installing snap rings on master cylinders or brakes



SNAP RING PLIERS IS

TANG SNAP RING - IS

ITEM CODE	SIZE	1 (mm)	2 (mm)	3 (mm)	4 (mm)	5 (mm)	6 (mm)	WEIGHT (gr)	QTY / BOX INNER/MASTER
PL-SR0780	5"	125	61	20	80	10	7	101	6 / 120 pcs
PL-SR0781	7"	175	82	21	100	10	7	159	6 / 120 pcs
PL-SR0782	9"	225	79	25	128	10	7	267	6 / 60 pcs

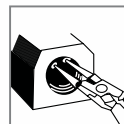
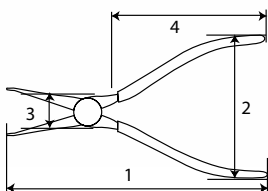

- Long life
- Ergonomic handle
- Convenient for removing / installing snap rings on master cylinders or brakes



WRENCH

TORQUE

SOCKET

IMPACT SOCKET

PLIER

SCREWDRIVER



WATERPUMP PLIERS

TEKIRO Multi-groove water pump plier is made of high quality material and provides step adjustment to various jaw openings. It is an ideal tool for every plumber.

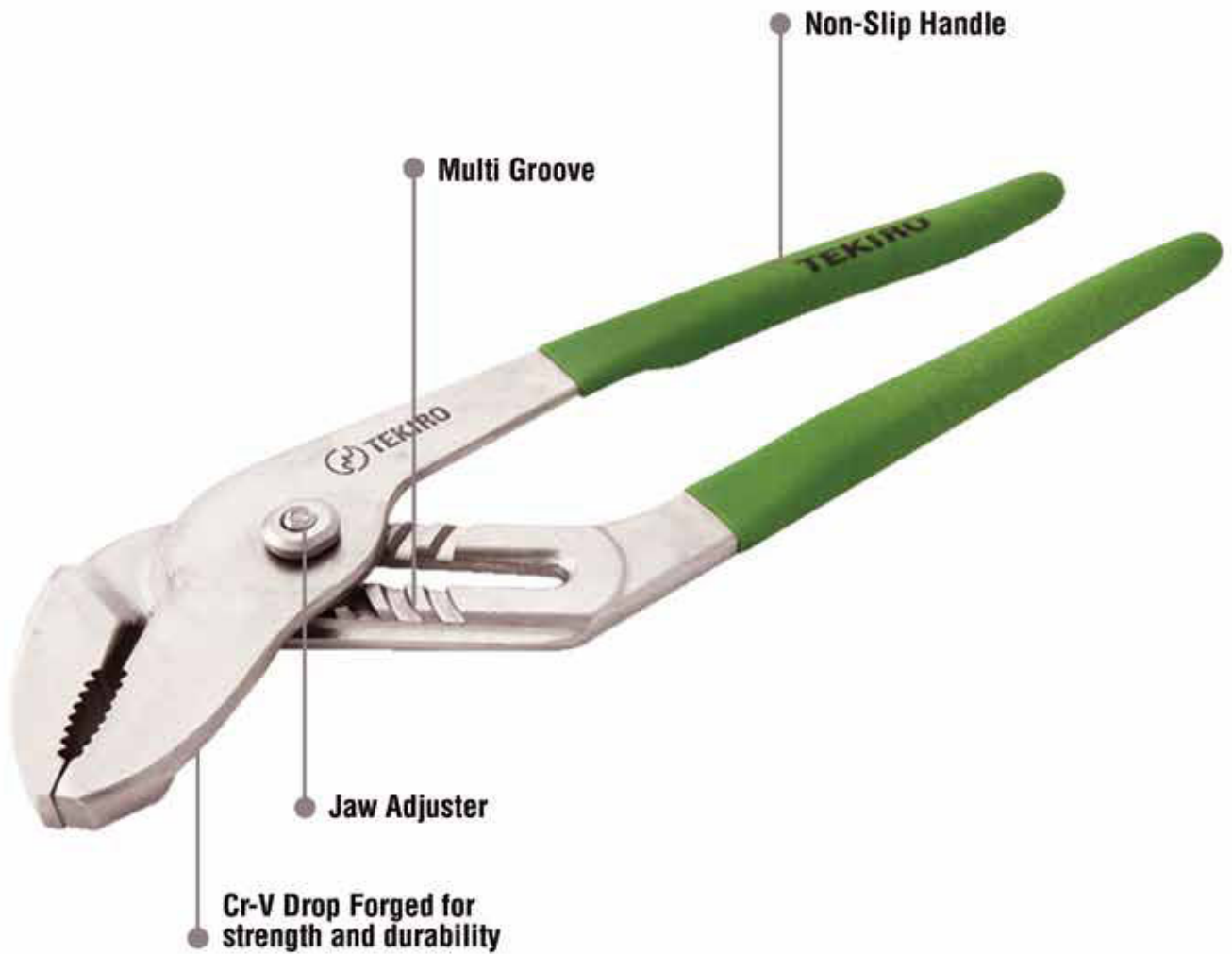

SLIP JOINT PLIERS

TANG SLIP JOINT

ITEM CODE	SIZE	1 (mm)	2 (mm)	3 (mm)	4 (mm)	5 (mm)	6 (mm)	7 (mm)	WEIGHT (gr)	QTY / BOX INNER/MASTER
PL-SJ0783	6"	150	3	29	56	78	11	5	210	6 / 60 pcs
PL-SJ0784	8"	200	9	32	48	111	11	5	270	6 / 60 pcs

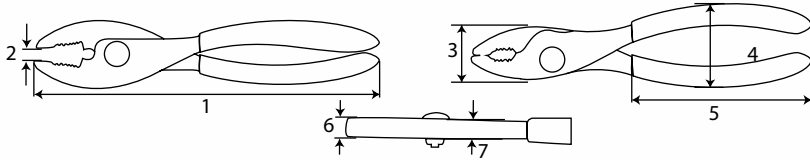

- Non slip handle
- Dual position joint allow use across a wide range of diameters
- For Gripping pipe, nuts and bolt



WATER PUMP PLIERS TYPE A6

TANG BURUNG

ITEM CODE	SIZE	1 (mm)	2 (mm)	3 (mm)	MAX. JAW OPENING (mm)	WEIGHT (gr)	QTY / BOX INNER/MASTER
PL-WP0785	10"	250	59	31	41	380	6 / 60 pcs
PL-WP0786	12"	300	70	44	49	620	6 / 60 pcs

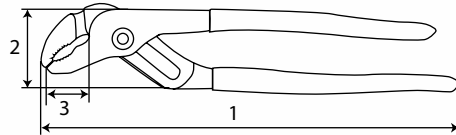

- Material Chrome Vanadium
- Heat treated alloy steel
- Drop forged for extra strength
- Highly fully polishing finish



CABLE CUTTER

TANG POTONG KABEL

ITEM CODE	SIZE	1 (mm)	2 (mm)	3 (mm)	4 (mm)	CUTTING CAPACITY	WEIGHT (gr)	QTY / BOX INNER/MASTER
PL-CC1695	6.5"	163	40	19	95	Max 16 mm ² (For Cable RG58/ RG59/RG6 and cable with steel component)	195	10 / 60 pcs

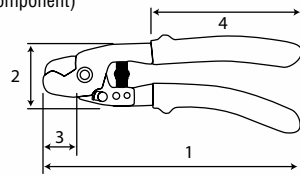

- Material heat treated high carbon steel
- High durable hardness
- High precision
- Anti slip handle



CABLE CUTTER

TANG POTONG KABEL

ITEM CODE	SIZE	1 (mm)	2 (mm)	FOR COOPER CABLE	FOR ALUMINUM CABLE	WEIGHT (gr)	QTY / BOX INNER/MASTER
PL-CC1448	10"	250	45	16 mm ² Solid 35 mm ² Stranded 70 mm ² Flexible	70 mm ² Stranded	457	1 / 60 pcs

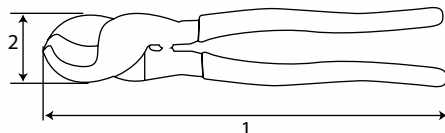

- Designed specifically to cut aluminum & soft copper
- High-leverage design
- One hand shear action
- Beveled jaw tips provide proper mating and shearing action
- Smooth cutting action and no wobble



WRENCH

TORQUE

SOCKET

IMPACT SOCKET

PLIER

SCREWDRIVER



ELECTRONIC PLIERS

Tools for electronic use are manufactured to high precision and excellent functionality. It guarantees a complete match with the objects being worked on, even in hard to access places. These tools provide several functions such as cutting, turning, bending, removing and pressing cables, which makes work faster and without additional physical strain. Top materials are carefully selected to manufacture these tools to prevent rapid wear.

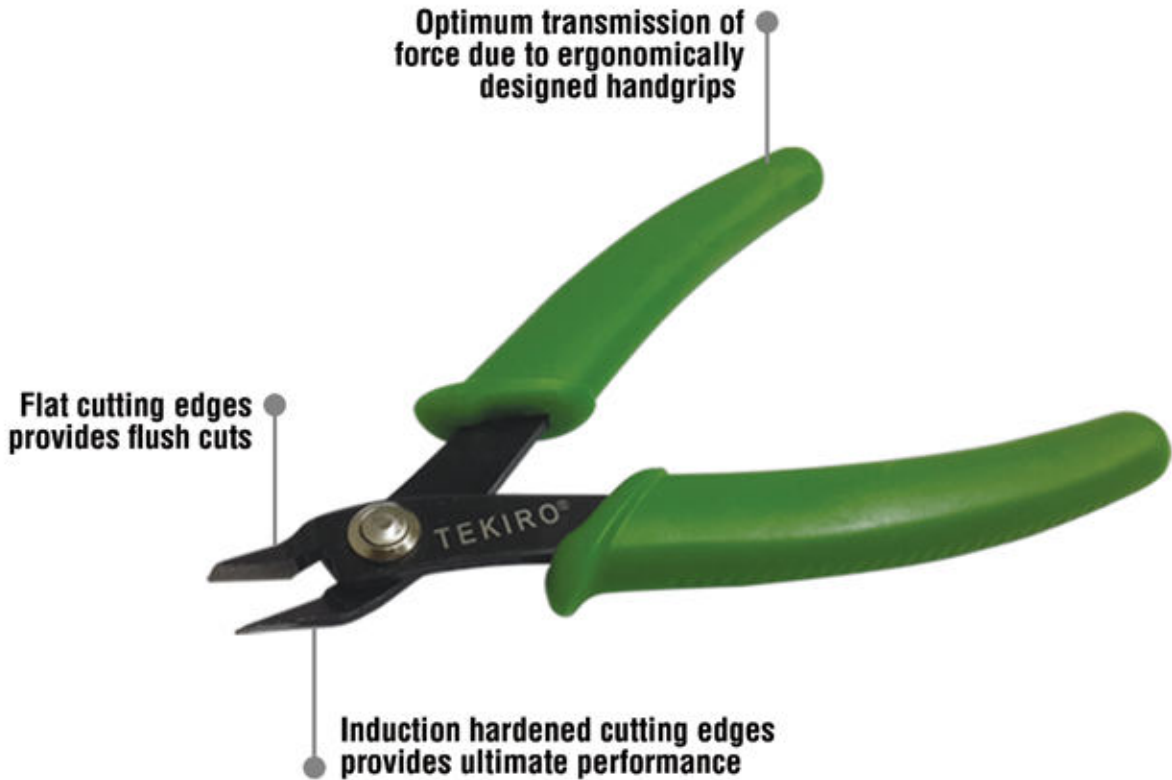

ELECTRONIC FLAT NOSE PLIERS

TANG LANCIP FLAT ELEKTRONIK

- Spring loaded action with hinge lock
- Ergonomic comfort grip handle

ITEM CODE	SIZE	1 (mm)	2 (mm)	3 (mm)	4 (mm)	CUTTING CAPACITY	WEIGHT (gr)	QTY / BOX INNER/MASTER
PL-EF1452	5"	125	91	23	14	Hard Steel : ø 1.6 mm Medium Steel : ø 2.0 mm	72	6 / 120 pcs

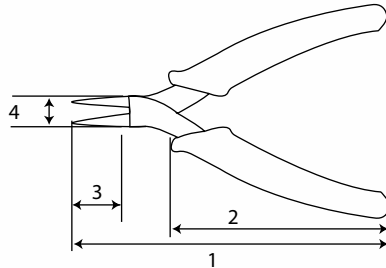

ELECTRONIC LONG NOSE PLIERS

TANG LANCIP ELEKTRONIK

- Spring loaded action with hinge lock
- Ergonomic comfort grip handle

ITEM CODE	SIZE	1 (mm)	2 (mm)	3 (mm)	4 (mm)	CUTTING CAPACITY	WEIGHT (gr)	QTY / BOX INNER/MASTER
PL-EL1450	5"	125	91	34	14	Hard Steel : ø 1.6 mm Medium Steel : ø 2.0 mm	73	6 / 120 pcs

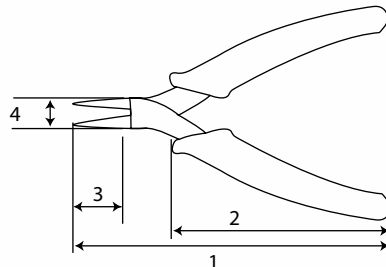

ELECTRONIC DIAGONAL CUTTING PLIERS

TANG POTONG ELEKTRONIK

- Durable hardened cutting knife
- Spring loaded action with hinge lock
- Ergonomic comfort grip handle

ITEM CODE	SIZE	1 (mm)	2 (mm)	3 (mm)	4 (mm)	CUTTING CAPACITY	WEIGHT (gr)	QTY / BOX INNER/MASTER
PL-ED1451	5"	125	91	14	11	Hard Steel : ø 1.6mm Medium Steel : ø 2.0mm	65	6 / 120 pcs

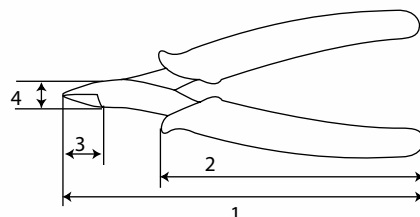

WRENCH

TORQUE

SOCKET

IMPACT SOCKET

PLIER

SCREWDRIVER



AVIATION SNIPS STRAIGHT PLIERS

The **TEKIRO** Aviation Snips are built to last. The powerful blades are made of forged chrome molybdenum alloy with heat-treated for strength. The handles are padded for comfort. Straight cutting snips designed to cut in a straight line and wide curves.

Blade :
Chrome Molybdenum (Cr-Mo)
drop forged with hardness of 56-64
HRC for durability and strength

Bolt

Safety Lock :
Unlock automatically when handles are pressed.
Hook to secure jaws together during storage

**High Quality Steel handle with
hardness 46-52HRC**

**PVC/TPR grip & ergonomic
designed non-slip handles
are strong & comfortable**



**Cutting
direction**



WRENCH

TORQUE

SOCKET

IMPACT SOCKET

PLIER

SCREWDRIVER

- Material Chrome Molybdenum
- High durable hardness
- High precision
- Comfortable anti slip grip
- Sharp and precise edge
- Can be use for medium thick zinc
- For cutting straight, left and right



AVIATION SNIPS

GUNTING SENG (TIPE LURUS)

ITEM CODE	SIZE	1 (mm)	2 (mm)	3 (mm)	WEIGHT (gr)	QTY / BOX INNER/MASTER
PL-AS1449	10"	250	50	49	378	6 / 60 pcs

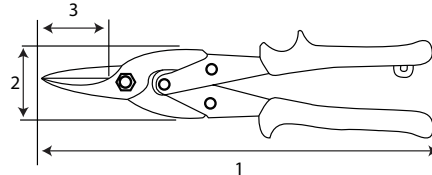

CUTTING CAPACITY

Soft Steel (Copper)	: 1.5 mm
Mild Steel (Cold Rolled Steel)	: 1.2 mm
Hard Steel (HRC 30)	: 1.0 mm
Hard Steel (HRC 40)	: 0.6 mm
Stainless Steel 304	: 0.9 mm



- Material Chrome Molybdenum
- High durable hardness
- High precision
- Comfortable anti slip grip
- Sharp and precise edge
- Can be use for medium thick zinc
- For cutting straight, left and right
- Extra lenght on jaws for faster cut



AVIATION SNIPS

GUNTING SENG PANJANG

ITEM CODE	SIZE	1 (mm)	2 (mm)	3 (mm)	WEIGHT (gr)	QTY / BOX INNER/MASTER
PL-AS1778	12"	305	50	85	520	6 / 48 pcs

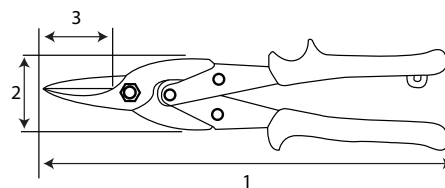

CUTTING CAPACITY

Soft Steel (Copper)	: 1.5 mm
Mild Steel (Cold Rolled Steel)	: 1.2 mm
Hard Steel (HRC 30)	: 1.0 mm
Hard Steel (HRC 40)	: 0.6 mm
Stainless Steel 304	: 0.9 mm



PLUG CRIMPER 3 IN 1

The all-in-one Ratcheting Modular Crimper/Stripper cuts, strips and crimps paired-conductor cables (round STP/UTP and flat-satin phone cables).



Compact and durable frame made of lightweight steel with black oxide finish

Ratcheting crimper

Reinforced zinc alloy back protection cover

Cuts and strips wire in one operation, easy and efficient

Punch down function

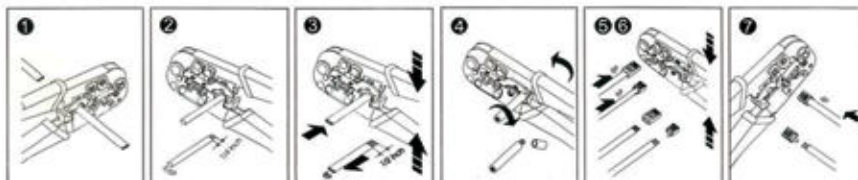

1. Cuts modular cable to the desired length
2. Strips modular cable (4P/6P)
3. Strips modular cable (8P)
4. Strips round cable
- 5,6. Inserts stripped cable into plug, and crimps (6P/8P)
7. Crimps modular cable (4P) on the back of the tool

2 BLADE CABLE STRIPPER

This tool gives users an easy and cost-effective way to cut and strip wire, coaxial cables, round cable and flat cable with replaceable blade.



Ergonomic Design

Adjustable stripping Diameter

Cutter

Round Cable Strippers

Flat Cable Strippers

High quality blade insert and easy to replace

Coaxial Cable Strippers

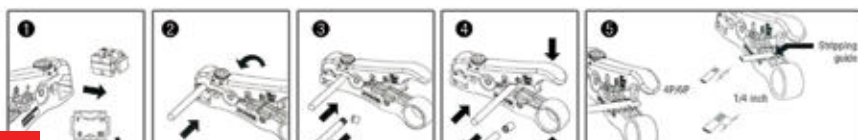

1. Cassette is reversible
2. Strips coaxial cable
3. Strips round cable
4. Cuts cable

- Chrome Molybdenum Die with Phosphate Manganese Finish
- For non-insulated terminal
- Ratchet action provide crimping strenght

RATCHET CRIMPING PRESS

TANG PRESS SKUN RATCHET

ITEM CODE	SIZE	Crimping Capacity (mm ²)	1 (mm)	2 (mm)	3 (mm)	WEIGHT (gr)	QTY / BOX INNER/MASTER
GT-RC1453	KH-8	DIN: 1.5, 2.5, 6.0, 10 JIS: 1.25, 2.0, 5.5, 8.0 AWG: 16-8	258	47	35	449	6 / 36 pcs
GT-RC1455	KH-16	DIN: 1-2, 6.0, 10, 16 JIS: 1.25, 2.0, 5.5, 8.0, 14 AWG: 16-5	280	51	50	477	6 / 36 pcs

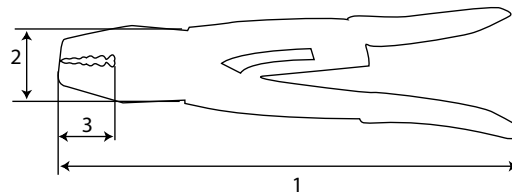

- High Quality Plastic
- High Quality Steel
- Comfort Grip
- Cuts, Strips and Crimps in one tool

PLUG CRIMPER 3 IN 1

TANG CRIMPING 3 IN 1

ITEM CODE	SIZE	1 (mm)	2 (mm)	3 (mm)	PLUG MODEL	WEIGHT (gr)	QTY / BOX INNER/MASTER
PL-PC1693	3 IN 1	185	52	34	8P8C/RJ-45 (Network Cable) 6P6C/RJ-12, 6P4C/RJ-11 (Phone Cable) 4P4C & 4P2C (Phone Handset Cable)	363	5 / 45 pcs

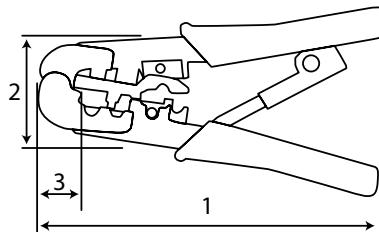

- Multi - functions crimping tool
- High - contrast size range markings
- Non - slip cushioned handle grips

FIVE WAY DELUXE CRIMPING TOOL

CRIMPING TIPE FIVE WAY DELUXE

ITEM CODE	SIZE	1 (mm)	2 (mm)	3 (mm)	WEIGHT (gr)	QTY / BOX INNER/MASTER
GT-FW1454	9"	224	38	39	240	25 / 100 pcs

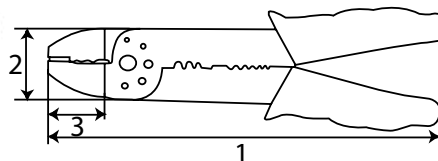

Crimping Capacity for Insulate Terminal : 1.5mm, 2.5mm, 6mm

Bolt Cutter : M2.6 - M5.0

Crimping Capacity for Open Barrel Terminal : 1.5 - 6mm

Stripping Capacity : 0.75 - 6.0mm²

AUTOMATIC WIRE STRIPPER

Multifunctional Automatic wire stripper for stripping, crimping and cutting. Wire is stripped automatically in a single motion without adjustment. Crimping of insulated and non-insulated terminals. Micro adjustment knob allows stripping wires smaller than 0.2mm².

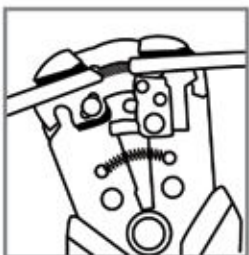

Strip Regular Wire
8-26 AWG
3-10mm

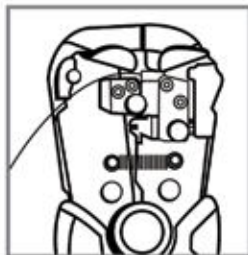

Tension Knob
micro-adjust for wire

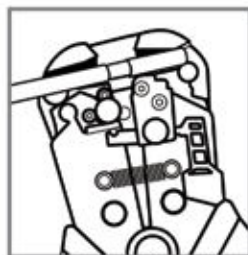

Strip Romex, NM,
UF 14/2 - 12/2

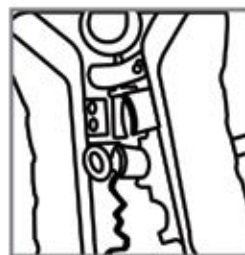

Crimp Insulated and
Non-Insulated terminal



Cut 10-30 AWG
(0.05-6mm²)

WRENCH

TORQUE

SOCKET

IMPACT SOCKET

PLIER

SCREWDRIVER

- High quality steel
- High quality plastic
- Adjustable stripping blade



2 BLADE CABLE STRIPPER

PISAU CUTTER PEMOTONG KABEL

ITEM CODE	SIZE	1 (mm)	2 (mm)	3 (mm)	4 (mm)	CABLE TYPE	STRIPPING DISTANCE	WEIGHT (gr)	QTY / BOX INNER/MASTER
PL-CB1694	4.9"	125	37	28	17	RG59/6/11/7 Coaxial Cable	6 mm	99	6 / 60 pcs

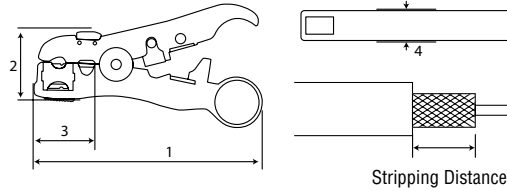

- High quality plastic
- High quality steel
- Comfort grip
- With the lock function that's convenient



FIBER OPTIC STRIPPING TOOL

TANG POTONG KABEL FIBER OPTIK

ITEM CODE	SIZE	1 (mm)	2 (mm)	3 (mm)	4 (mm)	STRIPPING CAPACITY	WEIGHT (gr)	QTY / BOX INNER/MASTER
PL-FO1696	6.3"	160	32	16	107	Outer Jacket : 2 mm Buffer Insulation : 900 µm Acrylate Coating : 250 µm	156	10 / 60 pcs

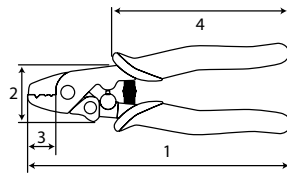

- High quality plastic
- High quality steel
- Comfort grip
- With the lock function that's convenient



AUTOMATIC WIRE STRIPPER

TANG PENGUPAS KABEL OTOMATIS

ITEM CODE	SIZE	1 (mm)	2 (mm)	3 (mm)	4 (mm)	TENSION KNOB MICRO ADJUST	WEIGHT (gr)	QTY / BOX INNER/MASTER
PL-AW1700	8"	205	48	52	152	30 AWG (0.05 mm ²)	397	10 / 60 pcs

STRIPPING CAPACITY	CRIMPING CAPACITY	CUTTING CAPACITY
8-26 AWG (0.13-10 mm ²) for regular wire	10-22 AWG (0.5-6 mm ²) for Insulated & Non-insulated Terminal	10-30 AWG (0.05-6mm ²) Stainless steel wire

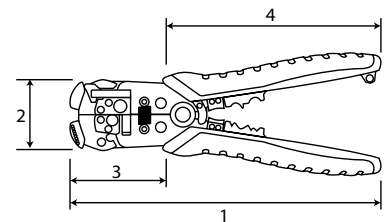

- Forged steel nickel finish
- High durable hardness
- PVC handle
- Special tools for cutting wires
- Can be used for cutting nails



TOWER PINCER

TANG KAKATUA

ITEM CODE	SIZE	1 (mm)	2 (mm)	3 (mm)	4 (mm)	CUTTING CAPACITY	WEIGHT (gr)	QTY / BOX INNER/MASTER
PL-TP1701	9"	226	29	15	135	Hard Wire : ø 1.8 mm Medium Wire : ø 2.0 mm Soft Wire : ø 3.4 mm	390	6 / 60 pcs

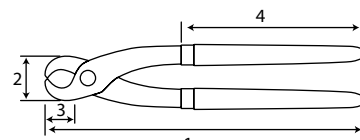

SCREWDRIVER





TEKIRO has a full range of screwdrivers to suit every job and application. It is very important for a user to choose the right grip, shaft and material for optimum torque and performance.

1. SELECT THE GRIP

One of the most important part of a screwdriver is the grip. The grip should fit ergonomically and comfortably into a user's hand. With just a light gripping force, it should generate sufficient torque to fasten or loosen screws with ease without hurting or causing serious injuries.

1.1 MATERIAL

A. Plastic (Hard)

Made of Acetate, hard durable material that do not get dirty easily.



B. Cushion Rubber (Soft)

Rubberised dimple provides soft and comfortable grip. Ideal for Mechanics with greasy hands.



C. PP + TPR

PP + TPR material provides comfortable grip, non slip and best for working with wet and oily hands.



1.2 SHAPE

A. Groove Type

Groove type fits comfortably in the hands of users facilitating maximum control and torque.



B. Square - Hexagonal Type

Square and hexagonal type have flat surfaces, improves grip and prevent screwdriver from rolling off.



2. SELECT THE SHAFT

The shaft is an important component as well as the grip. Select the correct shaft from the 5 points provided below.

2.1 GO THRU & NON GO THRU

One piece go through tang suitable for hammer blows at the end of the grip without damaging the tool.

A. Go Thru

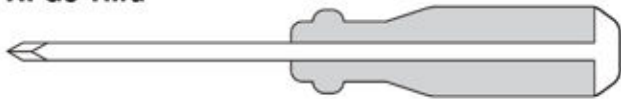

B. Non Go Thru

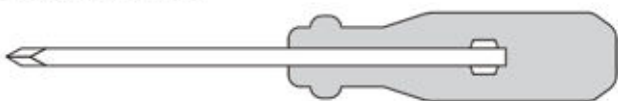

2.3 LENGTH

A. Stubby

Short and stout. High torque, more control. Ideal for tight spaces



B. Standard

Most commonly used. Suits most jobs and industries.

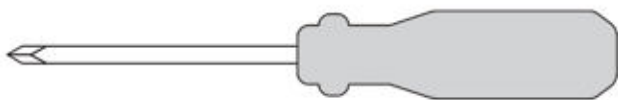

C. Long



2.2 SHAPE

A. Rounded

A common shape that is easy to use when turning while supporting the shaft with the hand.



B. Square / Hexagonal

Open end wrenchs can be used for leverage when high turning torque is needed.



2.4 MAGNETIC TIPS

Magnetized tip to hold screws and freeing up hand. Useful also for picking up screws



2.5 MATERIAL

A. SVCM

(Silicone Vanadium Chrome Molybdenum)

This material creates high torque, toughness and hardness. Higher than CrV or S2 Steel.

B. Cr-V (Chrome Vanadium)

A special steel that has anti-wear properties that are desired in screwdrivers. This is commonly used in most screwdrivers.

MATERIAL COMPARISON OF SCREWDRIVER

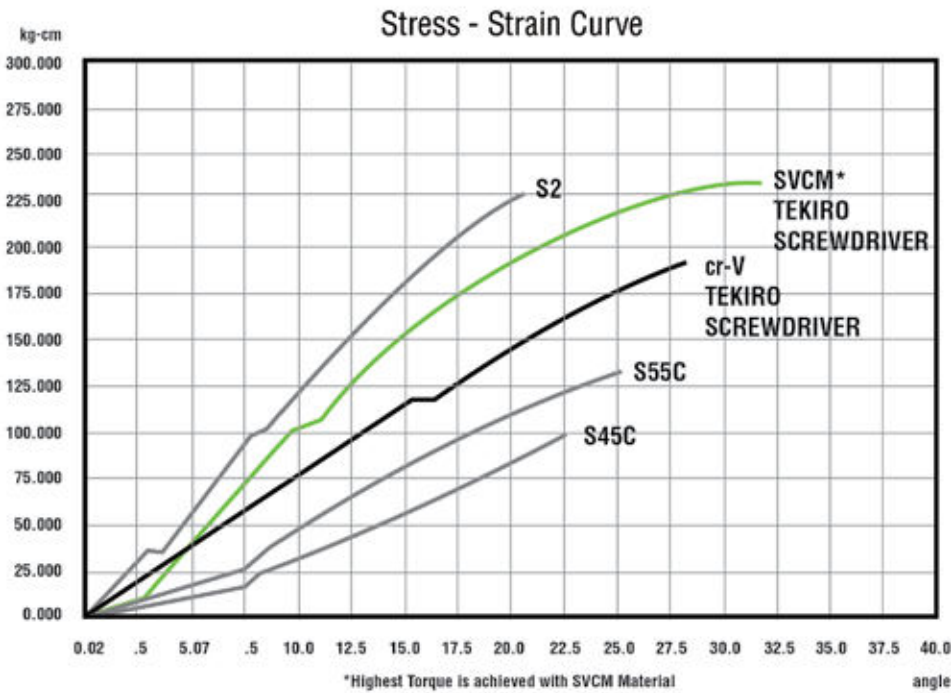

3. SELECT THE TIP

TEKIRO screwdriver has 4 tip options. Choose the tip that best fits the type of screw.



Slotted (SL)



Philips (PH)



Pozidriv (Pz)

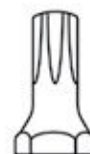

Torx (T)

SAFETY INSTRUCTION

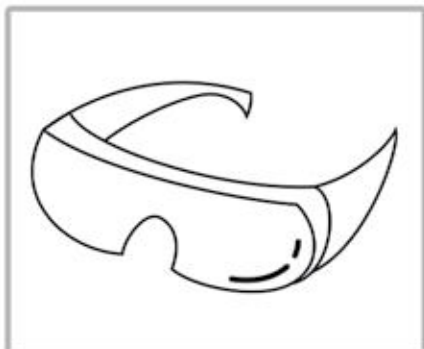

Wear Safety Glasses

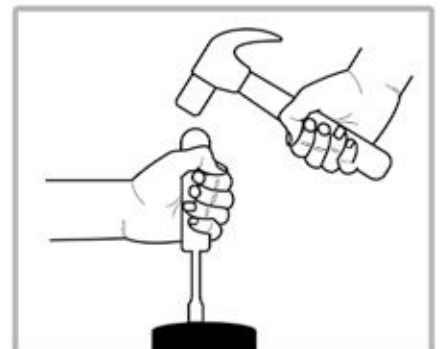
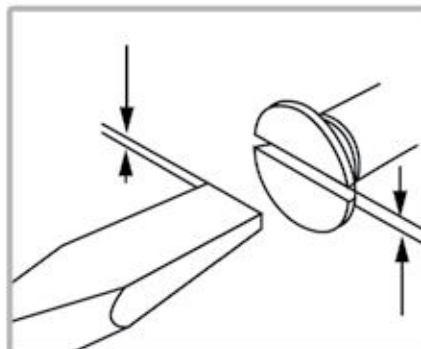

WWW.TEKIRO.COM

IN LINE SCREWDRIVER COLOR

OBENG KRISTAL

ITEM CODE		SIZE		1	2	3	4	5	WEIGHT	QTY / BOX
(+)	(-)	(+)	(-)	(mm)	(mm)	(mm)	(mm)	(mm)	(gr)	INNER/MASTER
SD-IL0789	SD-IL0819	PH00 X 50 mm (Ø 2.5)	2.5 X 50 mm	106	20	14	2	14	14	12 / 600 pcs
SD-IL0790	SD-IL0820	PH00 X 75 mm (Ø 2.5)	2.5 X 75 mm	132	750	15	2	15	15	12 / 600 pcs
SD-IL0791	SD-IL0821	PH00 X 100 mm (Ø 2.5)	2.5 X 100 mm	157	100	13	2	13	16	12 / 600 pcs
SD-IL0792	SD-IL0822	PH0 X 75 mm (Ø 3.2)	3.2 X 75 mm	131	75	14	3	14	17	12 / 600 pcs
SD-IL0793	SD-IL0823	PH0 X 100 mm (Ø 3.2)	3.2 X 100 mm	158	100	14	3	14	19	12 / 600 pcs
SD-IL0794	SD-IL0824	PH0 X 150 mm (Ø 3.2)	3.2 X 150 mm	209	150	15	3	15	22	12 / 600 pcs
SD-IL0795	SD-IL0825	PH0 X 200 mm (Ø 3.2)	3.2 X 200 mm	259	200	14	3	14	25	12 / 600 pcs
SD-IL0796	SD-IL0826	PH0 X 100 mm (Ø 4)	4 X 100 mm	158	100	14	4	14	22	12 / 600 pcs
SD-IL0797	SD-IL0827	PH0 X 125 mm (Ø 4)	4 X 125 mm	183	125	14	4	14	25	12 / 600 pcs
SD-IL0798	SD-IL0828	PH0 X 150 mm (Ø 4)	4 X 150 mm	208	150	14	4	14	28	12 / 600 pcs
SD-IL0799	SD-IL0829	PH0 X 200 mm (Ø 4)	4 X 200 mm	257	200	14	4	14	32	12 / 600 pcs
SD-IL0800	SD-IL0830	PH0 X 250 mm (Ø 4)	4 X 250 mm	303	250	14	4	14	37	12 / 600 pcs
SD-IL0801	SD-IL0831	PH1 X 75 mm (Ø 5)	5 X 75 mm	163	75	20	5	20	48	12 / 300 pcs
SD-IL0802	SD-IL0832	PH1 X 100 mm (Ø 5)	5 X 100 mm	190	100	20	5	20	55	12 / 300 pcs
SD-IL0803	SD-IL0833	PH1 X 125 mm (Ø 5)	5 X 125 mm	214	125	20	5	20	59	12 / 300 pcs
SD-IL0804	SD-IL0834	PH1 X 150 mm (Ø 5)	5 X 150 mm	242	150	20	5	20	62	12 / 300 pcs
SD-IL0805	SD-IL0835	PH1 X 200 mm (Ø 5)	5 X 200 mm	290	200	20	5	20	71	12 / 240 pcs
SD-IL0806	SD-IL0836	PH1 X 250 mm (Ø 5)	5 X 250 mm	340	250	20	5	20	78	12 / 240 pcs
SD-IL0807	SD-IL0837	PH1 X 300 mm (Ø 5)	5 X 300 mm	390	300	20	5	20	84	12 / 240 pcs
SD-IL0808	SD-IL0838	PH2 X 38 mm (Ø 6)	6 X 38 mm	87	38	26	6	26	44	12 / 300 pcs
SD-IL0809	SD-IL0839	PH2 X 100 mm (Ø 6)	6 X 100 mm	198	100	22	6	22	77	12 / 300 pcs
SD-IL0810	SD-IL0840	PH2 X 125 mm (Ø 6)	6 X 125 mm	224	125	22	6	22	81	12 / 300 pcs
SD-IL0811	SD-IL0841	PH2 X 150 mm (Ø 6)	6 X 150 mm	249	150	22	6	22	89	12 / 300 pcs
SD-IL0812	SD-IL0842	PH2 X 200 mm (Ø 6)	6 X 200 mm	299	200	22	6	22	98	12 / 240 pcs
SD-IL0813	SD-IL0843	PH2 X 250 mm (Ø 6)	6 X 250 mm	351	250	22	6	22	109	12 / 240 pcs
SD-IL0814	SD-IL0844	PH2 X 300 mm (Ø 6)	6 X 300 mm	398	300	22	6	22	120	12 / 240 pcs
SD-IL0815	SD-IL0845	PH3 X 150 mm (Ø 8)	8 X 150 mm	262	150	26	8	26	140	12 / 120 pcs
SD-IL0816	SD-IL0846	PH3 X 200 mm (Ø 8)	8 X 200 mm	312	200	26	8	26	157	12 / 120 pcs
SD-IL0817	SD-IL0847	PH3 X 250 mm (Ø 8)	8 X 250 mm	365	250	26	8	26	174	12 / 120 pcs
SD-IL0818	SD-IL0848	PH3 X 300 mm (Ø 8)	8 X 300 mm	398	300	26	8	26	192	12 / 120 pcs

- Material chrome vanadium
- Grip is made of Acetate material, hard and durable.

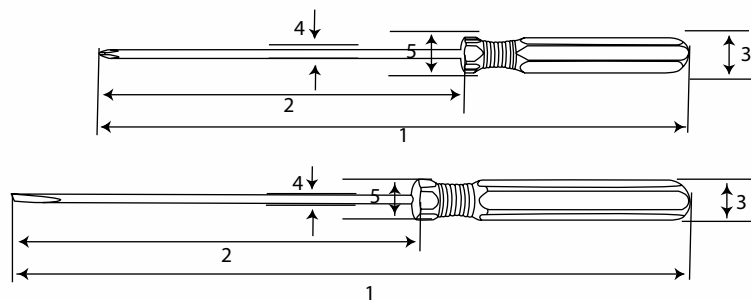

WRENCH

TORQUE

SOCKET

IMPACT SOCKET

PLIER

SCREWDRIVER



CUSHION GRIP SCREWDRIVER

The **TEKIRO** Cushion Grip screwdriver is constructed with a chrome vanadium steel for the shaft and SVCM steel for a magnetic tip for convenience when working. Features include a non-slip rubber cushion grip to give total control and comfort during operation.

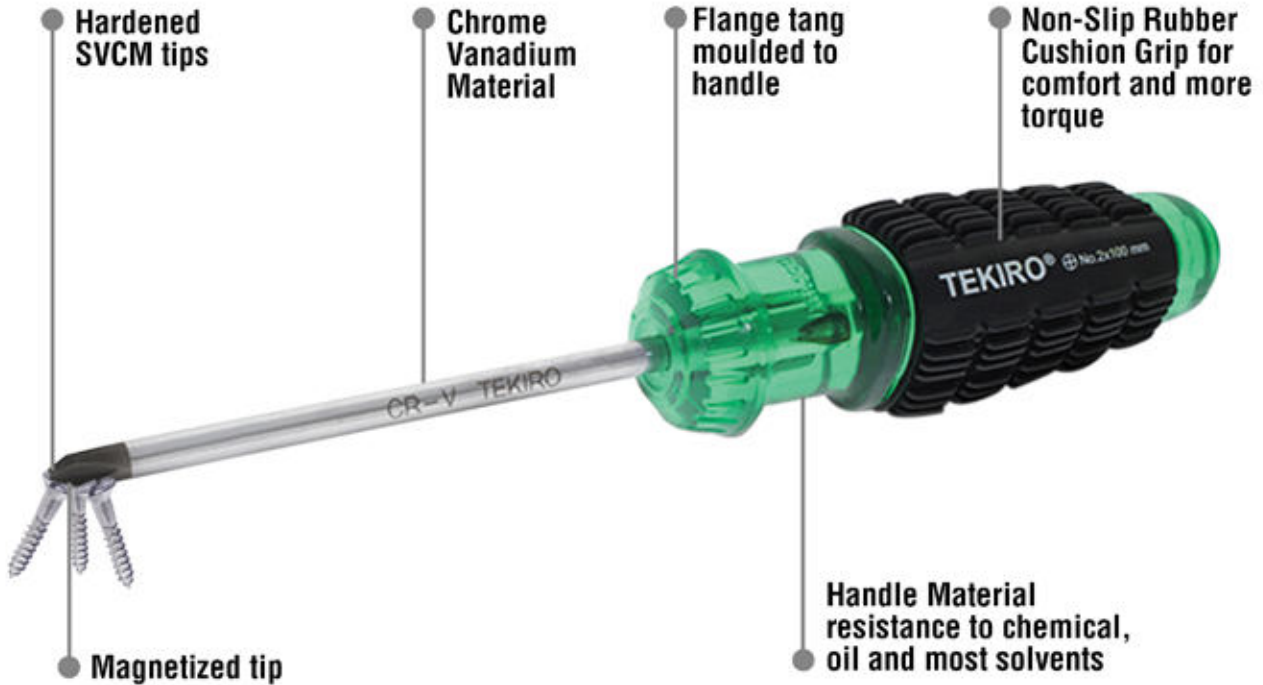

TPR SCREWDRIVER

TEKIRO TPR Screwdriver features a unique ergonomic hand moulded design handle with a combination of PP and TPR bi-material grip to promote comfort and high torque. It is also highly resistant against chemicals, oil and most solvents.

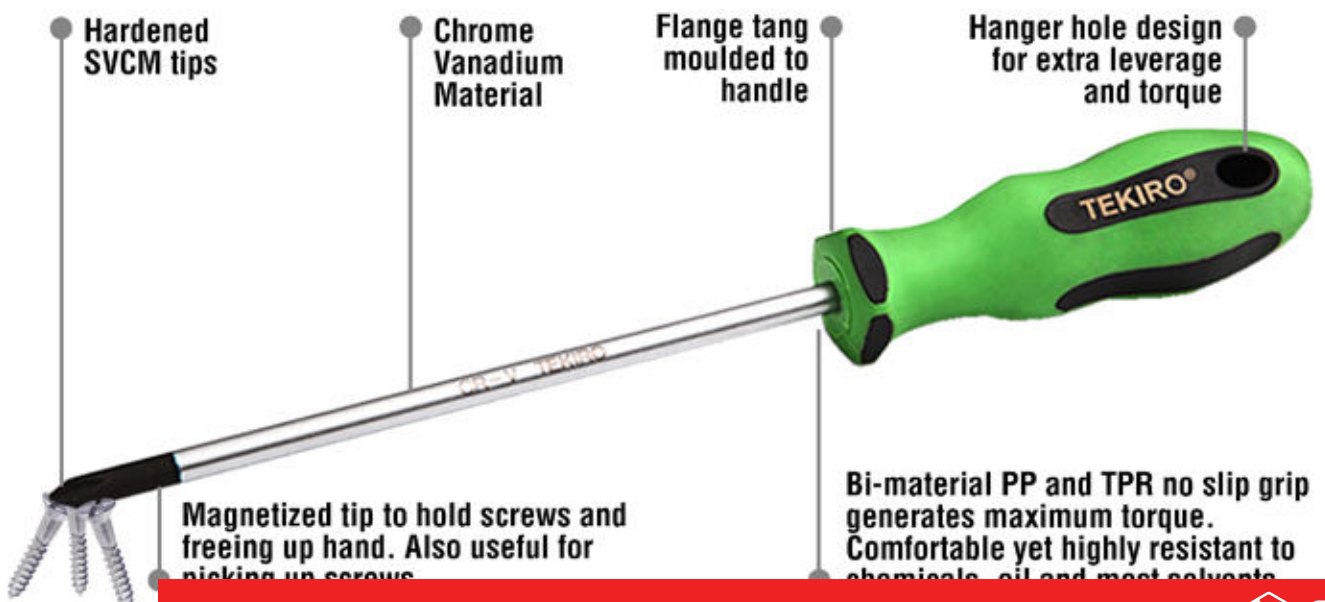

WWW.TEKIRO.COM

CUSHION GRIP SCREWDRIVER

OBENG GAGANG KARET

ITEM CODE		SIZE		1	2	3	4	5	WEIGHT	QTY / BOX
(+)	(-)	(+)	(-)	(mm)	(mm)	(mm)	(mm)	(mm)	(gr)	INNER/MASTER
SD-CG0850	SD-CG0858	PH1 X 75 mm (Ø 5)	5 X 75 mm	175	75	22	5	31	84	12 / 120 pcs
SD-CG0851	SD-CG0859	PH2 X 38 mm (Ø 6)	6 X 38 mm	100	38	27	6	31	66	12 / 300 pcs
SD-CG0852	SD-CG0860	PH2 X 100 mm (Ø 6)	6 X 100 mm	210	100	25	6	31	113	12 / 120 pcs
SD-CG0853	SD-CG0861	PH2 X 125 mm (Ø 6)	6 X 125 mm	234	125	28	6	31	119	12 / 120 pcs
SD-CG0854	SD-CG0862	PH2 X 150 mm (Ø 6)	6 X 150 mm	258	150	30	6	31	124	12 / 120 pcs
SD-CG0855	SD-CG0863	PH2 X 200 mm (Ø 6)	6 X 200 mm	310	200	30	6	31	135	12 / 120 pcs
SD-CG0856	SD-CG0864	PH2 X 250 mm (Ø 6)	6 X 250 mm	361	250	25	6	31	145	12 / 120 pcs
SD-CG0857	SD-CG0865	PH2 X 300 mm (Ø 6)	6 X 300 mm	410	300	30	6	31	156	12 / 120 pcs

- Larger, comfortable grip
- Generates extreme Torque
- Favourite with mechanics with oily hands

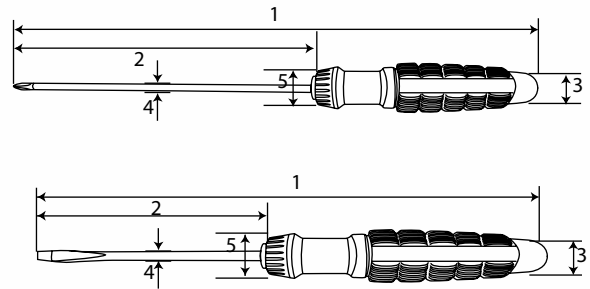

GO THRU SCREWDRIVER GREEN HANDLE

OBENG TEMBUS HIJAU

ITEM CODE		SIZE		1	2	3	4	5	WEIGHT	QTY / BOX
(+)	(-)	(+)	(-)	(mm)	(mm)	(mm)	(mm)	(mm)	(gr)	INNER/MASTER
SD-GT0866	SD-GT0874	PH1 X 75 mm (Ø 5)	5 x 75 mm	164	75	20	5	17	59	12 / 300 pcs
SD-GT0867	SD-GT0875	PH2 X 100 mm (Ø 6)	6 x 100 mm	200	100	26	6	24	105	12 / 240 pcs
SD-GT0868	SD-GT0876	PH2 X 125 mm (Ø 6)	6 x 125 mm	225	125	26	6	24	112	12 / 240 pcs
SD-GT0869	SD-GT0877	PH2 X 150 mm (Ø 6)	6 x 150 mm	253	150	26	6	24	120	12 / 240 pcs
SD-GT0870	SD-GT0878	PH2 X 200 mm (Ø 6)	6 x 200 mm	306	200	26	6	24	134	12 / 240 pcs
SD-GT0871	SD-GT0879	PH3 X 200 mm (Ø 8)	8 x 200 mm	312	200	27	8	26	209	12 / 120 pcs
SD-GT0872	SD-GT0880	PH3 X 250 mm (Ø 8)	8 x 250 mm	360	250	27	8	26	234	12 / 120 pcs
SD-GT0873	SD-GT0881	PH3 X 300 mm (Ø 8)	8 x 300 mm	413	300	27	8	26	256	12 / 120 pcs

- Material : CrV
- Shaft : Square type
- Grip Material: PVC
- This screwdriver is trusted by mechanics for decades
It is used together with hammers to loosen screws with some impact

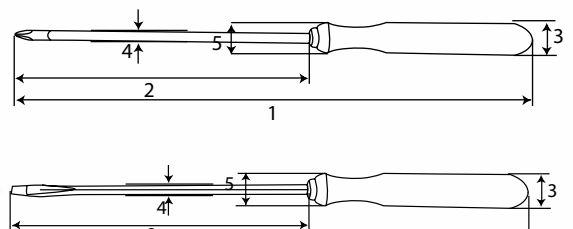

TPR SCREWDRIVER

OBENG TPR

ITEM CODE		SIZE		1	2	3	4	5	WEIGHT	QTY / BOX
(+)	(-)	(+)	(-)	(mm)	(mm)	(mm)	(mm)	(mm)	(gr)	INNER/MASTER
SD-TR0882	SD-TR0898	PH0 X 150 mm (Ø 3)	3 X 150 mm	221	150	21	3	17	23	12 / 600 pcs
SD-TR0883	SD-TR0899	PH0 X 200 mm (Ø 3)	3 X 200 mm	270	200	21	3	17	28	12 / 600 pcs
SD-TR0884	SD-TR0900	PH0 X 100 mm (Ø 4)	4 X 100 mm	210	100	22	4	22	27	12 / 600 pcs
SD-TR0885	SD-TR0901	PH0 X 150 mm (Ø 4)	4 X 150 mm	219	150	22	4	22	32	12 / 600 pcs
SD-TR0886	SD-TR0902	PH0 X 200 mm (Ø 4)	4 X 200 mm	262	200	22	4	22	36	12 / 600 pcs
SD-TR0888	SD-TR0903	PH1 X 75 mm (Ø 5)	5 X 75 mm	176	75	25	5	25	61	12 / 300 pcs
SD-TR0889	SD-TR0904	PH1 X 100 mm (Ø 5)	5 X 100 mm	201	101	26	6	26	63	12 / 300 pcs
SD-TR0890	SD-TR0905	PH1 X 125 mm (Ø 5)	5 X 125 mm	236	127	30	6	27	133	12 / 300 pcs
SD-TR0891	SD-TR0906	PH1 X 150 mm (Ø 5)	5 X 150 mm	256	150	25	5	25	72	12 / 240 pcs
SD-TR0892	SD-TR0907	PH2 X 38 mm (Ø 6)	6 X 38 mm	103	38	32	6	26	44	12 / 300 pcs
SD-TR0893	SD-TR0908	PH2 X 100 mm (Ø 6)	6 X 100 mm	209	100	31	6	31	87	12 / 240 pcs
SD-TR0894	SD-TR0909	PH2 X 125 mm (Ø 6)	6 X 125 mm	245	125	31	6	31	91	12 / 180 pcs
SD-TR0887	SD-TR0910	PH2 X 150 mm (Ø 6)	6 X 150 mm	260	150	31	6	31	97	12 / 180 pcs
SD-TR0895	SD-TR0911	PH2 X 200 mm (Ø 6)	6 X 200 mm	310	200	31	6	31	108	12 / 120 pcs
SD-TR0896	SD-TR0912	PH2 X 250 mm (Ø 6)	6 X 250 mm	355	252	31	6	28	118	12 / 120 pcs
SD-TR0897	SD-TR0913	PH2 X 300 mm (Ø 6)	6 X 300 mm	408	300	31	6	31	129	12 / 120 pcs

- SVCM material steel blade is better than CrV in terms of hardness and generating torque
- PP+ TPR material prevents slippage, and highly resistance to oil and most solvents
- Blades are chrome plated with satin finishing for rust prevention
- Highly precise tip-end magnetized and black oxide finish for extra durability

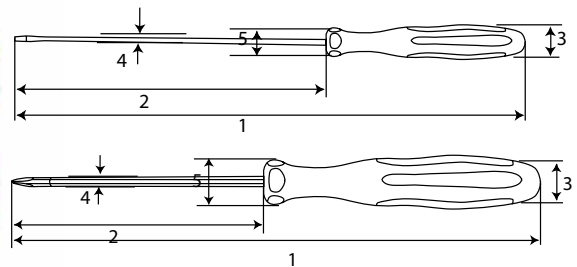

TPR EXTRA LONG SCREWDRIVER

OBENG TPR EXTRA PANJANG

ITEM CODE	SIZE	1	2	3	4	5	WEIGHT	QTY / BOX
		(mm)	(mm)	(mm)	(mm)	(mm)	(gr)	INNER/MASTER
SD-TE1502	(-) 5.5 X 400 MM	500	400	30	5	24	117.5	12 / 72 pcs
SD-TE1503	(+) PH1 X 400MM (5)	500	400	30	5	24	117.5	12 / 72 pcs
SD-TE1630	(+) PH2 X 400MM (6)	510	400	29	6	27	117.5	12 / 72 pcs

- SVCM material steel blade is better than CrV in terms of hardness and generating torque
- PP+ TPR material prevents slippage, and highly resistance to oil and most solvents
- Blades are chrome plated with satin finishing for rust prevention
- Highly precise tip-end magnetized and black oxide finish for extra durability
- Extra long for greater access and reaching tight deep spaces
- Parallel tip on slotted screwdriver

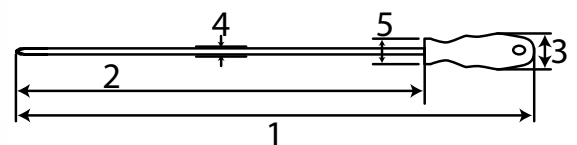

TPR GO THRU SCREWDRIVER

TEKIRO TPR Go-Thru screwdriver combines the advantages of the TPR design handle with a one-piece tang shaft from tip to grip. Ideal for hammer blows.

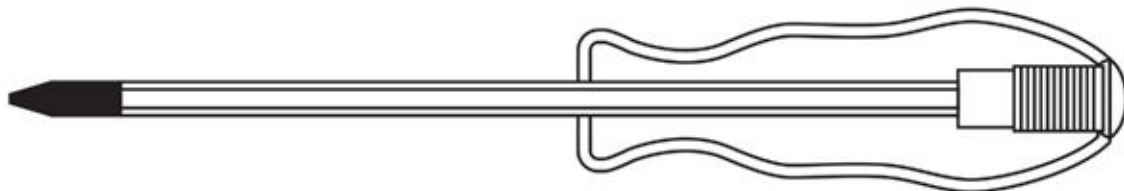
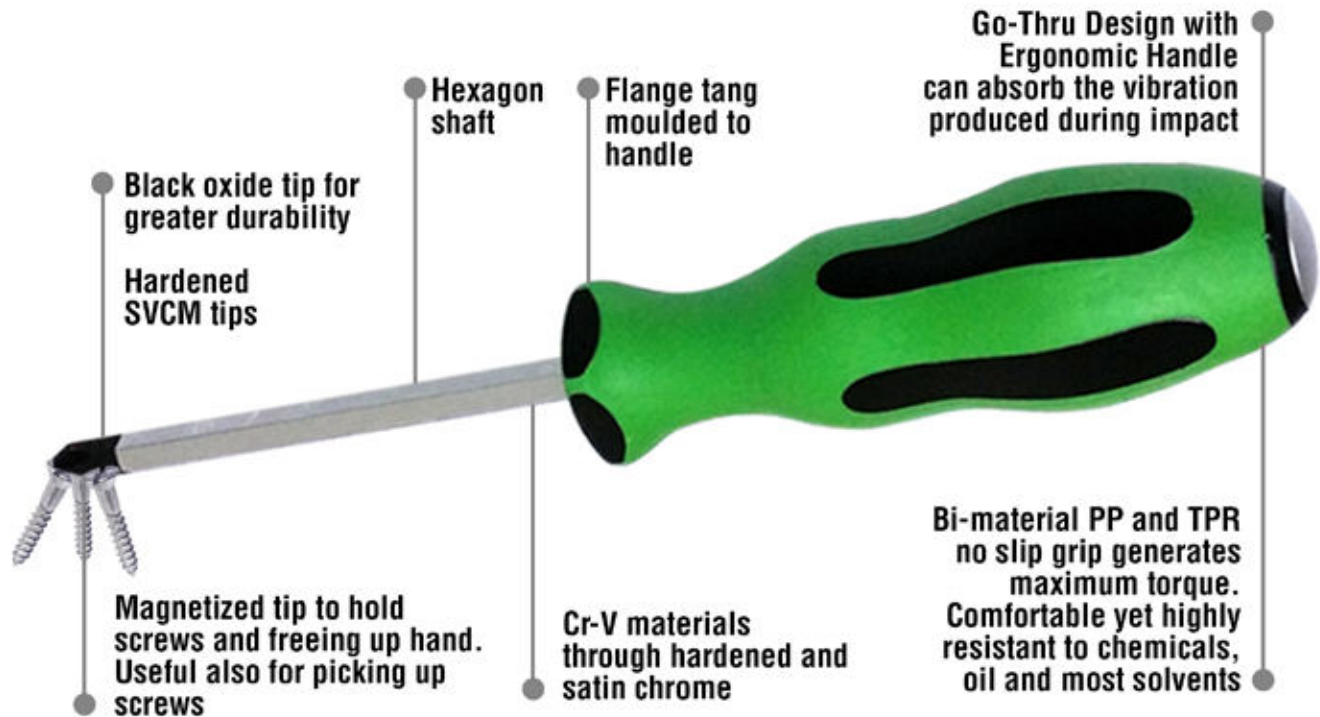

One-piece tang thru designed specifically for hammer blows to deliver shock directly to the screws



WRENCH

TORQUE

SOCKET

IMPACT SOCKET

PLIER

SCREWDRIVER

TPR GO THRU SCREWDRIVER

OBENG TPR TEMBUS

ITEM CODE		SIZE		1	2	3	4	5	WEIGHT	QTY / BOX
(+)	(-)	(+)	(-)	(mm)	(mm)	(mm)	(mm)	(mm)	(gr)	INNER/MASTER
SD-TG0940	SD-TG0948	PH1 x 75 mm (Ø5)	5 x 75 mm	175	76	30	5	25	86	12 / 240 pcs
SD-TG0941	SD-TG0949	PH2 x 100 mm (Ø6)	6 x 100 mm	210	100	32	6	27	128	12 / 180 pcs
SD-TG0942	SD-TG0950	PH2 x 125 mm (Ø6)	6 x 125 mm	237	128	27	6	27	133	12 / 180 pcs
SD-TG0943	SD-TG0951	PH2 x 150 mm (Ø6)	6 x 150 mm	261	150	27	6	27	143	12 / 180 pcs
SD-TG0944	SD-TG0952	PH2 x 200 mm (Ø6)	6 x 200 mm	310	203	27	6	27	153	12 / 120 pcs
SD-TG0945	SD-TG0953	PH3 x 200 mm (Ø8)	8 x 200 mm	320	201	32	8	30	237	6 / 96 pcs
SD-TG0946	SD-TG0954	PH3 x 250 mm (Ø8)	8 x 250 mm	370	252	31	8	30	259	6 / 72 pcs
SD-TG0947	SD-TG0955	PH3 x 300 mm (Ø8)	8 x 300 mm	420	300	32	8	30	280	6 / 72 pcs

- One Piece tang thru for impact and hammer blows
- SVCM material steel blade is better than CrV in terms of hardness and generating torque.
- PP+ TPR material prevents slippage, and highly resistance to oil and most solvents
- Blades are chrome plated with satin finishing for rust prevention
- Shaft is hexagon shaped for greater strength
- Highly precise tip-end magnetized and black oxide finish for extra durability

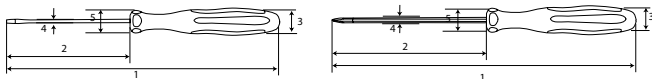

2 WAY SCREWDRIVER

OBENG DUA ARAH

ITEM CODE	SIZE		1	2	3	4	5	WEIGHT	QTY / BOX
	(+)	(-)	(mm)	(mm)	(mm)	(mm)	(mm)		
SD-TW0849	PH2 X 125 mm	6 X 125 mm	111	12	150	31	11	130	12 / 120 pcs

- 2 in 1 fuction for convenient use
- 2 - tone big handle for holding well
- Highly durable

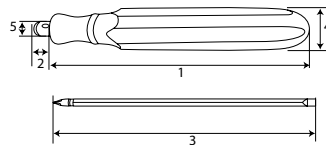

TPR 2 WAY SCREWDRIVER

OBENG TPR DUA ARAH

ITEM CODE	SIZE		1	2	3	4	5	WEIGHT	QTY / BOX
	(+)	(-)	(mm)	(mm)	(mm)	(mm)	(mm)		
SD-TR0957	PH2 x 125 mm	6 x 125 mm	123	30	28	143	6	105	6 / 48 pcs

- SVCM material steel blade is better than CrV in terms of hardness and generating torque
- PP+TPR material prevents slippage, and highly resistance to oil and most solvents
- Blades are chrome plated with satin finishing for rust prevention
- Shaft is hexagon shaped for greater strength
- Interchangeable bits for portability and convenience



Tersedia di : 

2 IN 1 STUBBY SCREWDRIVER

OBENG STUBBY DUA ARAH

ITEM CODE	SIZE		1 (mm)	2 (mm)	3 (mm)	4 (mm)	WEIGHT (gr)	QTY / BOX INNER/MASTER
	(+)	(-)						
SD-SS1466	PH2 x 65mm	6 x 65mm	68	65	32	14	45	6 / 48 pcs

- 2 In1 function for convenient use
- Suitable for narrow space using
- Bi-material handle for holding well

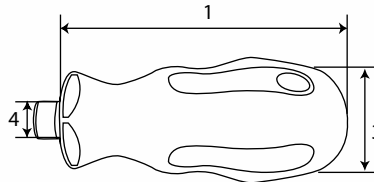
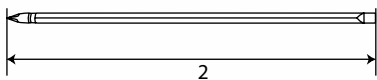

INSULATION PRECISION SCREWDRIVER SET 6 PCS

OBENG LISTRIK PRESISI SET 6 PCS

ITEM CODE	CONTENT	WEIGHT (gr)	QTY / BOX INNER/MASTER
SD-IP0930	3 pcs Precision Screwdriver Slotted 25 mm (-) 1.4 mm, 1.8 mm, 2.4 mm	254	12 / 48 pcs
	3 pcs Precision Screwdriver Philips 25 mm (+) PH00, PH0, (+) PH1		

- Heat treated chrome vanadium
- Rotate cap
- Multiple size



12 IN 1 PRECISION SCREWDRIVER SET

OBENG SET 12 IN 1

ITEM CODE	CONTENT	WEIGHT (gr)	QTY / BOX INNER/MASTER
SD-PR0933	3 pcs Precision Screwdriver Slotted 120 mm (-) 2.0 mm, 3.0 mm, 4.0 mm	190	12 / 96 set
	3 pcs Precision Screwdriver Philips 120 mm (+) PH00, PH0, (+) PH1		
	6 pcs Torx Bits 120 mm T5, T6, T8, T10, T15, T20		

- Heat treated chrome vanadium
- Rotate cap
- Multiple size



WRENCH

TORQUE

SOCKET

IMPACT SOCKET

PLIER

SCREWDRIVER



PRECISION SCREWDRIVER SET 6 PCS

OBENG SET 6 PCS

ITEM CODE	CONTENT	WEIGHT (gr)	QTY / BOX INNER/MASTER
SD-PE0937	3 pcs Precision Screwdriver Slotted 25 mm (-) 1.4, 1.8, 2.4	155	12 / 96 set
	3 pcs Precision Screwdriver Philips 25 mm (+) PH00, PH0, PH1		

- High quality rubber handle
- Durable
- Multiple size



PRECISION SCREWDRIVER SET 30 PCS

OBENG SET PRESISI 30 PCS



ITEM CODE	CONTENT	WEIGHT (gr)	QTY / BOX INNER/MASTER
SD-PS0936	9 pcs Torx Bits T4, T5, T6, T7, T8, T9, 10, T15, T20	235	6 / 36 set
	8 pcs Hex Bits 0.7 mm, 0.9 mm, 1.3 mm, 1.5 mm 2.0 mm, 2.5 mm, 3.0 mm, 4.0 mm		
	7 pcs Slotted Bits (-) 1.0 mm, 1.5 mm, 2.0 mm, 2.5 mm, 3.0 mm, 3.5 mm, 4.0 mm		
	4 pcs Philips Bits (+) PH000, PH00, PH0, PH1		
	2 pcs Pozi Bits PZ0, PZ1		

- High quality rubber handle
- Durable
- Multiple size



GO THRU SCREWDRIVER SET 7 PCS

OBENG TEMBUS SET 7 PCS



ITEM CODE	CONTENT	WEIGHT (gr)	QTY / BOX INNER/MASTER
SD-GT0932	4 pcs Go Thru Screwdriver Slotted (-) 5.0 x 75 mm, 6.0 x 100 mm (-) 6.0 x 150 mm, 8.0 x 200 mm	889	6 / 24 set
	3 pcs Go Thru Screwdriver Philips (+) PH1 x 75 mm, PH2 x 100 mm (+) PH3 x 150 mm		

- Durable
- Multiple size



TPR GO THRU SCREWDRIVER SET 7 PCS

OBENG TPR TEMBUS SET 7 PCS

ITEM CODE	CONTENT	WEIGHT (gr)	QTY / BOX INNER/MASTER
SD-TG0956	4 pcs Go Thru Screwdriver Slotted	1,200	4 / 16 set
	(-) 5.0 x 75 mm, 6.0 x 100 mm		
	(-) 8.0 x 150 mm, 9.5 x 200 mm		
	3 pcs Go Thru Screwdriver Philips		
	(+) PH1 x 75 mm, PH2 x 100 mm		
	(+) PH3 x 150 mm		



IN LINE COLOR SCREWDRIVER SET 7 PCS

OBENG KRISTAL SET 7 PCS

ITEM CODE	CONTENT	WEIGHT (gr)	QTY / BOX INNER/MASTER
SD-IL0935	4 pcs In Line Screwdriver Slotted	254	10 / 40 set
	(-) 2.5 x 100 mm, 6.0 x 38 mm		
	(-) 6.0 x 100 mm, 8.0 x 150 mm		
	3 pcs In Line Screwdriver Philips		
	(+) PH2 x 38 mm, PH2 x 100 mm		
	(+) PH3 x 150 mm		

- Chrome vanadium finish
- High quality plastic handle
- High durable hardness



CUSHION GRIP SCREWDRIVER 7 PCS

OBENG GAGANG KARET SET 7 PCS

ITEM CODE	CONTENT	WEIGHT (gr)	QTY / BOX INNER/MASTER
SD-CG0934	4 pcs Cushion Grip Screwdriver Slotted	874	5 / 25 set
	(-) 5.0 x 75 mm, 6.0 x 38 mm		
	(-) 6.0 x 100 mm, 6.0 x 150 mm		
	3 pcs Cushion Grip Screwdriver Philips		
	(+) PH1 x 75 mm, PH2 x 100 mm		
	(+) PH2 x 150 mm		

- Material is SVCM steel blade is better than CR-V hardness and torsion
- Anti slip handle
- High quality plastic & rubber handle



WRENCH

TORQUE

SOCKET

IMPACT SOCKET

PLIER

SCREWDRIVER

INSULATION SCREWDRIVER SET 7 PCS

OBENG LISTRIK SET 7 PCS



ITEM CODE	CONTENT	WEIGHT (gr)	QTY / BOX INNER/MASTER
SD-EL0938	4 pcs Insulation Screwdriver Slotted (-) 4.0 x 100 mm, 5.5 x 125 mm (-) 6.5 x 150 mm, 8.0 x 150 mm	811	6 / 18 set
	3 pcs Insulation Screwdriver Philips (+) PH1 x 80 mm, PH2 x 100 mm (+) PH3 x 150 mm Auto Voltage Tester		

- High quality rubber handle
- Anti slip handle
- Safe for medium voltage

IMPACT DRIVER SET 5 PCS PE BOX

OBENG KETOK 5 PCS BOX PE (PLASTIK)



ITEM CODE	CONTENT	1 (mm)	2 (mm)	WEIGHT (gr)	QTY / BOX INNER/MASTER
SD-IM1698	1 pcs Impact Driver	157	30	173	1 / 20 set
	2 pcs Impact Bit 80 mm Slotted (-) 8.0, 10.0				
	2 pcs Impact Bit 80 mm Philips (+) PH2, PH3				

- High durable hardness
- Comfort grip
- Strong for hard impact
- With blow mould case

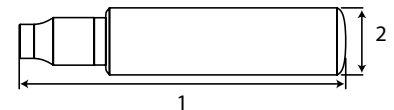

MINI IMPACT DRIVER AND EXTRACTOR SET 7 PCS

OBENG KETOK MINI 7 PCS



ITEM CODE	CONTENT	1 (mm)	2 (mm)	3 (mm)	WEIGHT (gr)	QTY / BOX INNER/MASTER
SD-MI1691	1 pcs Mini Impact Driver	135	17	10	331.5	12 / 48 pcs
	3 pcs 1/4" x 50 mm Impact Bits (+) PH1, PH2, (-) 5 mm					
	3 pcs 1/4" x 50 mm Screw Extractor No.1 - 1/8" - 1/4" (M3-M6) No.2 - 1/4" - 5/16" (M6-M8) No.3 - 5/16" - 7/16" (M8-M11)					

- High durable hardness
- Comfort grip
- Strong for hard impact
- CR-V is used for bit material
- Light & easy to use and especially for loosening tightly fastened bolt or rusted bolts

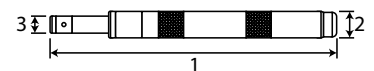

IMPACT DRIVER SET 9 PCS

OBENG KETOK SET 9 PCS

ITEM CODE	CONTENT	WEIGHT (gr)	QTY / BOX INNER/MASTER
SD-IM0922	1 pcs Impact Driver	1,130	1 / 18 set
	2 pcs Impact Bit Slotted 36 mm (-) 8.0 , 10.0		
	2 pcs Impact Bit Philips 36 mm (+) PH2, PH3		
	1 pcs Impact Bit Slotted 80 mm (-) 8.0		
	3 pcs Impact Bit Philips 80 mm (+) PH2, PH3, PH4		



- High durable hardness
- Comfort grip
- Strong for hard impact
- With plastic tray

IMPACT DRIVER SET 11 PCS

OBENG KETOK SET 11 PCS

ITEM CODE	CONTENT	WEIGHT (gr)	QTY / BOX INNER/MASTER	
SD-IM0921	1 pcs Impact Driver	1,160	1 / 10 set	
	2 pcs Impact Bit Slotted 36 mm (-) 8.0 , 10.0			
	2 pcs Impact Bit Philips 36 mm (+) PH2, PH3			
	2 pcs Impact Bit Slotted 80 mm (-) 8.0 , 10.0			
	2 pcs Impact Bit Philips 80 mm (+) PH2, PH3			
	2 pcs Screw Extractor No.3 - 5/16" - 7/16" (M8-M11)			
				No.4 - 7/16" - 9/16" (M11-M14)



- High durable hardness
- Comfort grip
- Strong for hard impact
- With blow mould case

HEAVY DUTY IMPACT BITS SET 12 PCS

MATA OBENG KETOK SET 12 PCS

ITEM CODE	SIZE	WEIGHT (gr)	QTY / BOX INNER/MASTER
SD-IB0924	PH 2 (+)	363	10 / 60 set
SD-IB1287	PH 3 (+)	363	10 / 60 set
SD-IB0925	PH 2 (-)	363	10 / 60 set



- S2 Materials

WRENCH

TORQUE

SOCKET

IMPACT SOCKET

PLIER

SCREWDRIVER



19 IN 1 INTERCHANGEABLE SCREWDRIVER SET

Convenient ratcheting screwdriver with multiple screwdriver bits in one tool. High turning ratio mechanism reduces fatigue and increases the speed of tightening or loosening screws with every single turn.

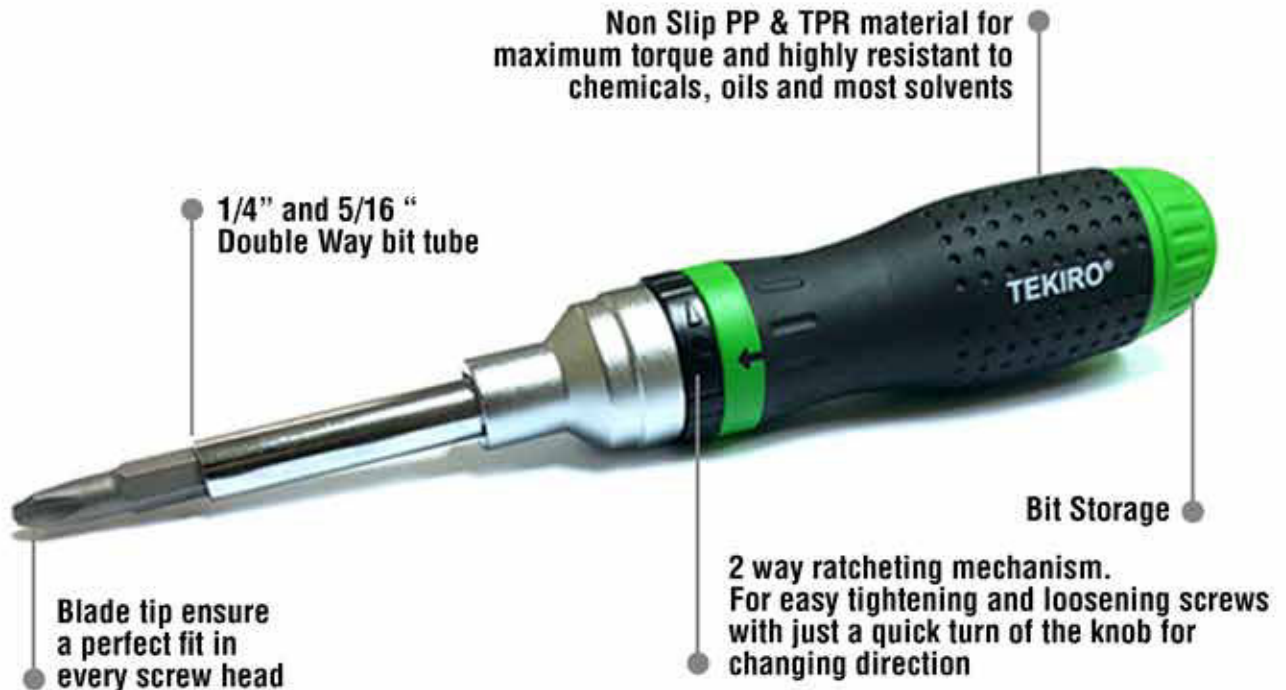

Perfect Handle Design



High Quality Ratchet



Integrated Storage



Multifunctions

19 IN 1 INTERCHANGEABLE SCREWDRIVER SET

OBENG SET 19 IN 1

ITEM CODE	CONTENT	WEIGHT (gr)	QTY / BOX INNER/MASTER
SD-IS1465	2 pcs 1/4"x75 mm Precision Bit (-) 2.0 & (+) PH00	387	6 / 48 set
	12 pcs 1/4"x75 mm Double End Bit (-) 4.0 & (+) PH0 (-) 5.0 & (+) PH1 (-) 6.0 & (+) PH2 (+) PH1 & (+) PH2		
	2.5 mm, 3.0 mm 4.0 mm, 5.0 mm		
	2 pcs 5/16"x75 mm Double End Bit (-) 8.0 & (+) PH3		
	2 pcs Nut Driver on Tube 1/4" & 5/16"		
	1 pcs Nut Driver on Ratchet 7/16"		



- Integrated storage
- High quality ratchet
- Perfect handle design
- Ratchet mechanism that's capable of quick turning in both tightening and loosening direction

STUBBY RATCHET AND BITS SET 7 IN 1

OBENG RATCHET STUBBY SET 7 IN 1

ITEM CODE	CONTENT	1 (mm)	2 (mm)	3 (mm)	4 (mm)	WEIGHT (gr)	QTY / BOX INNER/MASTER
SD-SR1699	1 pcs Stubby Ratchet Bit Driver	79	17	35	9	333	6 / 48 pcs
	3 pcs 1/4" x 25 mm Bits (+) PH1, PH2, PH3						
	3 pcs (-) 3.0, 4.0, 5.0, 6.0 mm						

- High quality handle for comfort grip
- Multiple tip
- Durable
- Convenient for attaching / detaching screw in narrow spaces
- 2 way ratcheting mechanism. For easy tightening and loosening screws with just a quick turn of the knob for changing direction.

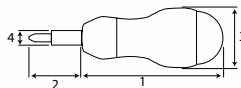

DOUBLE ENDED SCREW DRIVER BIT SET 10 PCS

MATA OBENG ANGIN SET 10 PCS

ITEM CODE	SIZE	WEIGHT (gr)	QTY / BOX INNER/MASTER
SD-DE0958	PH1 X 65	235	12 / 48 set
SD-DE0927	PH2 X 65	233	12 / 48 set
SD-DE0928	PH2 X 110	268	10 / 60 set
SD-DE0929	PH2 (-) 6 X 65	232	12 / 48 set

- High hardness
- Durable
- Easy storage



WRENCH

TORQUE

SOCKET

IMPACT SOCKET

PLIER

SCREWDRIVER

SCREW EXTRACTOR SET 6 PCS

TAP BALIK SET 6 PCS



ITEM CODE	CONTENT	WEIGHT (gr)	QTY / BOX INNER/MASTER
SD-EX0926	6 pcs Screw Extractor	215	10 / 100 set
	No.1 - 1/8" - 1/4" (M3-M6)		
	No.2 - 1/4" - 5/16" (M6-M8)		
	No.3 - 5/16" - 7/16" (M8-M11)		
	No.4 - 7/16" - 9/16" (M11-M14)		
	No.5 - 9/16" - 3/4" (M14-M18)		
No.6 - 3/4" - 1" (M18-M25)			

- Easy to use
- Highly durable
- Multiple size
- To remove damaged screw heads

MINI POCKET SCREWDRIVER 4 IN 1

OBENG TYPE PEN 4 IN 1



ITEM CODE	CONTENT	1 (mm)	2 (mm)	WEIGHT (gr)	QTY / BOX INNER/MASTER
SD-MP1692	2 pcs Precision Screwdriver 52 mm (-)1.6 (+)PH00	130	52	29.0	50 / 200 pcs
	2 pcs Precision Screwdriver 130 mm (-)3.0 (+)PH0				

- High quality plastic
- Durable
- Easy to use
- CR-V MATERIALS
- Light & easy to use and can put in your pocket
- Mobile phone, glassess watch usage

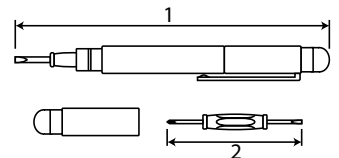

MAGNETIC HEX NUT

KUNCI MATA ROOFING



ITEM CODE	SIZE	1 (mm)	2 (mm)	3 (mm)	4 (mm)	WEIGHT (gr)	QTY / BOX INNER/MASTER
SD-MH1406	6 X 65 mm	65	11	6	6	190	10 / 60 set
SD-MH1407	8 X 65 mm	65	13	6	8	192	10 / 60 set
SD-MH1408	10 X 65 mm	65	11	6	10	174	10 / 60 set

- Heat treated for high torque strength
- Silver matt finishing

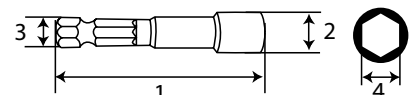



- Material chrome vanadium
- Highly durable
- Easy to use
- Corrosion resistance

ENGINE BLOCK WRENCH FOR MOTORCYCLE 10"

KUNCI BLOK MESIN BENGKOK

ITEM CODE	SIZE	1 (mm)	2 (mm)	3 (mm)	4 (mm)	5 (mm)	6 (mm)	7 (mm)	WEIGHT (gr)	QTY / BOX INNER/MASTER
AU-EB0960	10"	250	17	24	35	42	16	5	255	6 / 60 pcs

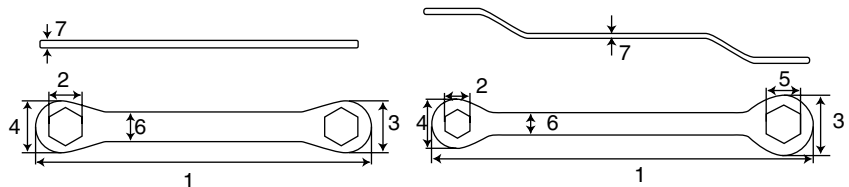

- Heat treated alloy steel
- Drop forged for extra strenght
- High quality powder coating finish

OIL FILTER WRENCH (CHAIN TYPE)

KUNCI OLI FILTER (TIPE RANTAI)

ITEM CODE	SIZE	1 (mm)	2 (mm)	3 (mm)	4 (mm)	5 (mm)	6 (mm)	WEIGHT (gr)	QTY / BOX INNER/MASTER
AU-OF0961	6"	415	160	17	18	4	4	407	6 / 48 pcs
AU-OF0962	9"	500	230	24	21	5	9	419	6 / 36 pcs

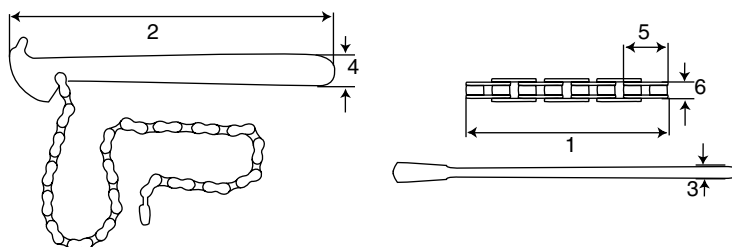

- Heat treated alloy steel
- Drop forged for extra strenght
- High quality powder coating finish

OIL FILTER WRENCH (BELT TYPE)

KUNCI OLI FILTER (TIPE SABUK) 9"

ITEM CODE	SIZE	1 (mm)	2 (mm)	3 (mm)	4 (mm)	5 (mm)	6 (mm)	WEIGHT (gr)	QTY / BOX INNER/MASTER
AU-OF0963	9"	520	229	10	20	23	19	310	6 / 72 pcs

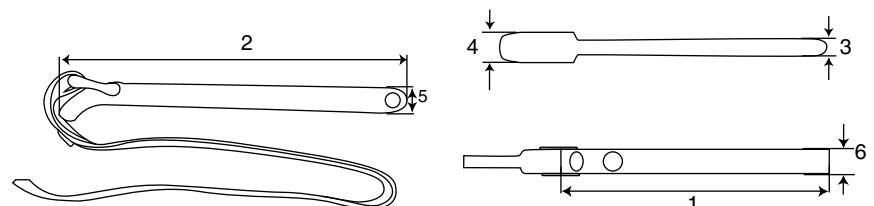

OIL FILTER WRENCH BOWL

KUNCI OLI FILTER (MANGKOK)

ITEM CODE	SIZE	1 (mm)	2 (mm)	3 (mm)	4 (mm)	5 (mm)	WEIGHT (gr)	QTY / BOX INNER/MASTER
AU-OF0964	64 mm	72	26	26	72	35	77	12 / 120 pcs
AU-OF1468	66.5 mm	76	26	26	73	34	82	12 / 120 pcs
AU-OF1469	72.5 mm	78	26	26	78	36	80	12 / 48 pcs
AU-OF0965	74 mm	80	26	26	81	35	90	12 / 120 pcs
AU-OF0966	79 mm	79	26	26	85	42	109	12 / 120 pcs
AU-OF0967	89 mm	95	26	26	96	41	112	12 / 120 pcs
AU-OF0968	99 mm	106	26	26	106	46	138	12 / 120 pcs

DESCRIPTION

64 mm = Avanza, CRV Lama, City
 66.5 mm = Xenia
 72.5 mm = Innova
 74 mm = BMW, VW, Audi, Opel, Harley, Innova
 79 mm = Kijang Kapsul, Taruna, Feroza, Ford
 89 mm = Civic, Mitsubishi, Panther Lama
 99 mm = Colt Diesel, Panther

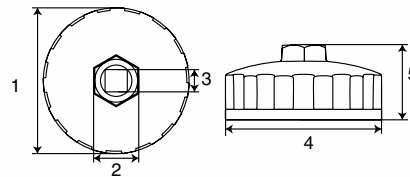

- Material Chrome Vanadium
- Remove and install Oil filter easily and quickly
- Hold the oil filter simply and firmly
- Suitable for 1/2" and 3/8" DR. Ratchet handle

2 WAY OIL FILTER WRENCH

KUNCI OLI FILTER (TIPE 2 ARAH)

ITEM CODE	SIZE	1 (mm)	2 (mm)	WEIGHT (gr)	QTY / BOX INNER/MASTER
AU-OF0969	63 -102 mm	22	14	377	12 / 48 pcs

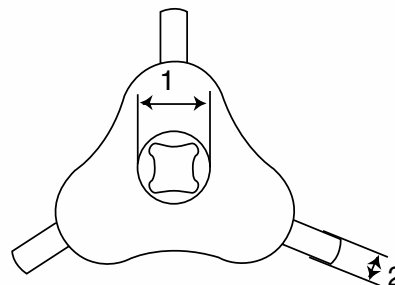

- Material Chrome Vanadium
- Remove and install Oil filter easily and quickly
- Hold the oil filter simply and firmly
- Suitable for 1/2" and 3/8" DR. Ratchet handle

AUTO VOLTAGE TESTER

TESPEN DC

ITEM CODE	SIZE	1 (mm)	2 (mm)	3 (mm)	4 (mm)	5 (mm)	WEIGHT (gr)	QTY / BOX INNER/MASTER
AU-VT1061	DC	15	143	70	70	0.5	377	12 / 120 pcs

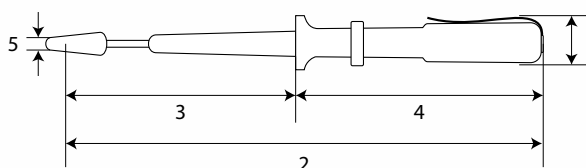

- High quality plastic
- Elastic cable
- Indicator lamp for easy check





DRAIN PLUG WRENCH

KUNCI OLI GARDAN

ITEM CODE	SIZE	1 (mm)	2 (mm)	3 (mm)	WEIGHT (gr)	QTY / BOX INNER/MASTER
AU-DP0970	8 X 10 mm	280	8	10	347	12 / 48 pcs
AU-DP0971	10 X 10 mm	271	10	10	345	12 / 48 pcs

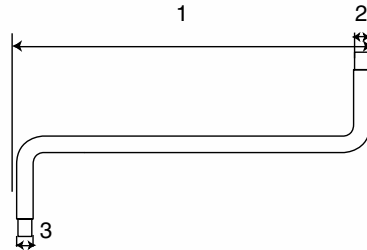

- Material Chrome Vanadium
- Heat treated Chrome vanadium steel
- Drop forged for extra strenght
- Silver matt finish



WHEEL NUT WRENCH

KUNCI SOCK RODA TARIK HITAM

ITEM CODE	SIZE	1 (mm)	2 (mm)	3 (mm)	4 (mm)	WEIGHT (gr)	QTY / BOX INNER/MASTER
AU-WN0972	10 mm	255	71	10	12	326	6 / 48 pcs
AU-WN0973	12 mm	256	74	12	12	349	6 / 48 pcs
AU-WN0974	14 mm	245	78	14	13	358	6 / 48 pcs

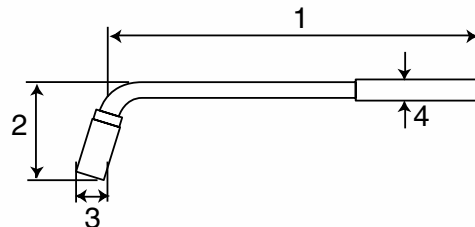

- CRV head socket
- High durable rusty painting



WHEEL MASTER WRENCH CR-V SOCK

KUNCI RODA TARIK

ITEM CODE	SIZE	1 (mm)	2 (mm)	3 (mm)	4 (mm)	5 (mm)	6 (mm)	7 (mm)	WEIGHT (gr)	QTY / BOX INNER/MASTER
AU-WM0975	19 X 21 mm	335	90	110	19	29	20	517	885	6 / 24 pcs

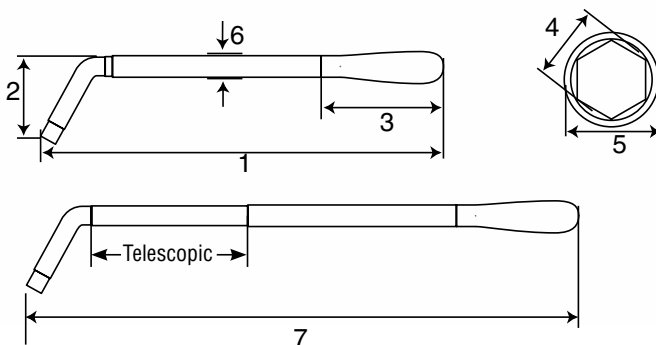

- Heavy duty and durable quality
- Telescopic handle for overstanding leverage
- Non - slip handgrip for comfortable holding



AUTOMOTIVE

STORAGE

TRAY

AIR TOOLS

HEX KEY

GENERAL TOOLS

- Heavy duty and durable quality
- Manganese Phosphate coating to help resist corrosion and ensure an extra life time of use

TYRE RIM WRENCH

KUNCI SOCK RODA TRUCK HITAM

ITEM CODE	SIZE	1 (mm)	2 (mm)	3 (mm)	4 (mm)	5 (mm)	WEIGHT (gr)	QTY / BOX INNER/MASTER
AU-WN1461	20 X 38 X 440 mm	595	37	55	435	37	3,454	2 / 8 pcs
AU-WN1462	21 X 41 X 440 mm	595	39	58	440	39	3,844	2 / 8 pcs

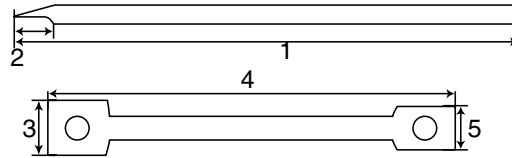

- CRV head socket
- High durable chrome finishing for rust prevention

4 WAY CROSS WRENCH 14"

KUNCI RODA PALANG 14"

ITEM CODE	SIZE	1 (mm)	2 (mm)	3 (mm)	4 (mm)	WEIGHT (gr)	QTY / BOX INNER/MASTER
AU-WC1463	17 X 19 X 21 X 23 mm	353	26	17 - 19 - 21 - 23	23	1,204	1 / 10 pcs

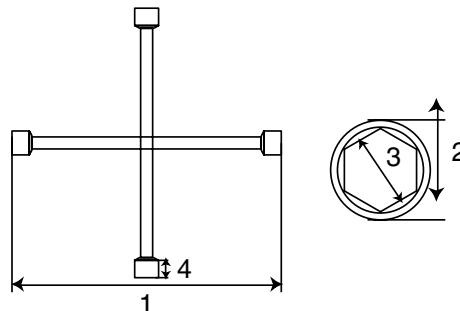

- Material Chrome Vanadium
- CRV head socket
- High durable chrome finishing for rust prevention

WHEEL NUT WRENCH

KUNCI RODA L

ITEM CODE	SIZE	1 (mm)	2 (mm)	3 (mm)	4 (mm)	5 (mm)	6 (mm)	WEIGHT (gr)	QTY / BOX INNER/MASTER
AU-WN0976	19 mm	298	95	27	20	28	15	529	1 / 24 pcs
AU-WN0977	21 mm	300	95	27	21	30	15	510	1 / 24 pcs

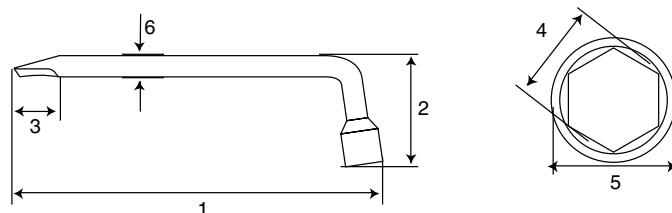

FEELER GAUGE

ALAT UKUR CELAH SET 13 PCS

- Material Chrome Vanadium
- Complete range size
- Longer leaves allow accurate measuring

ITEM CODE	SIZE	1 (mm)	2 (mm)	3 (mm)	4 (mm)	5 (mm)	6 (mm)	WEIGHT (gr)	QTY / BOX INNER/MASTER
AU-FG1292	0.05 mm; 0.10 mm; 0.15 mm; 0.20 mm; 0.25 mm; 0.30 mm; 0.40 mm; 0.50 mm; 0.60 mm; 0.70 mm; 0.80 mm; 0.90 mm; 1.00 mm	106	13	8	100	14	16	57	1 / 120 pcs

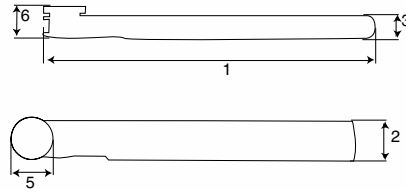
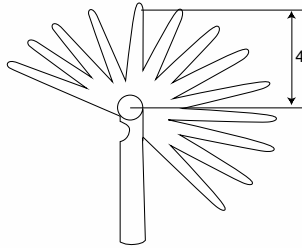

FEELER GAUGE ROLL

ALAT UKUR CELAH ROLL

- Material Chrome Vanadium
- Complete range size
- Longer leaves allow accurate measuring

ITEM CODE	SIZE	1 (mm)	2 (mm)	3 (mm)	WEIGHT (gr)	QTY / BOX INNER/MASTER
AU-FG1293	0.02 mm X 13 X 5	5,000	18	94	40	10 / 100 pcs
AU-FG1294	0.03 mm X 13 X 5	5,000	18	94	47	10 / 100 pcs
AU-FG1295	0.04 mm X 13 X 5	5,000	18	94	51	10 / 100 pcs
AU-FG1296	0.05 mm X 13 X 5	5,000	18	94	60	10 / 100 pcs
AU-FG1297	0.06 mm X 13 X 5	5,000	18	94	61	10 / 100 pcs
AU-FG1298	0.07 mm X 13 X 5	5,000	18	94	65	10 / 100 pcs
AU-FG1299	0.08 mm X 13 X 5	5,000	18	94	70	10 / 100 pcs
AU-FG1300	0.09 mm X 13 X 5	5,000	18	94	61	10 / 100 pcs
AU-FG1301	0.10 mm X 13 X 5	5,000	18	94	85	10 / 100 pcs

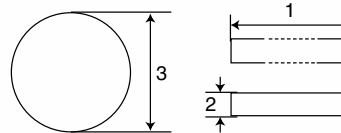

TIRE PRESSURE GAUGE

ALAT UKUR TEKanan ANGIN BAN

- Material Chrome Vanadium

ITEM CODE	SIZE	1 (mm)	2 (mm)	3 (mm)	4 (mm)	WEIGHT (gr)	QTY / BOX INNER/MASTER
AU-TG0980	60 lb	220	142	10	8	38	50 / 250 pcs
AU-TG0981	120 lb	220	142	10	8	40	50 / 250 pcs

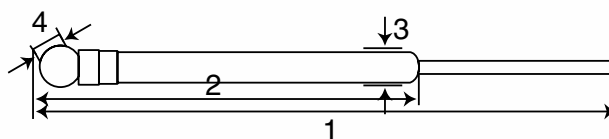

- Heavy duty and durable quality
- Material Chrome Vanadium

TIRE PRESSURE GAUGE

ALAT UKUR TEKANAN ANGIN BAN

ITEM CODE	SIZE	1 (mm)	2 (mm)	3 (mm)	4 (mm)	5 (mm)	6 (mm)	7 (mm)	WEIGHT (gr)	QTY / BOX INNER/MASTER
AU-TG0982	# 7 (160 psi)	272	10	27	14	8	372	15	120	10 / 100 pcs
AU-TG0983	# 9 (200 psi)	272	10	27	14	8	372	15	140	10 / 100 pcs

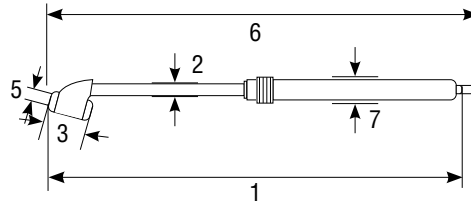

- Material Chrome Vanadium
- Dual head pump up
- Hanging hole design
- Air inflow enlarge

AIR CHUCK 6"

ALAT ISI ANGIN 6"

ITEM CODE	SIZE	1 (mm)	2 (mm)	3 (mm)	WEIGHT (gr)	QTY / BOX INNER/MASTER
AU-AC0984	Chrome 6"	170	9	15	115	10 / 100 pcs

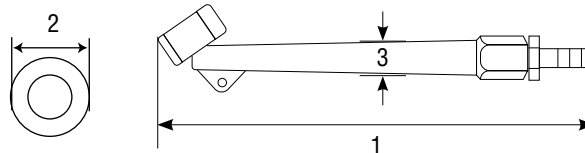

3/8" DR. TUNE UP KIT 5 PCS

3/8" TUNE UP KIT SET 5 PCS

ITEM CODE	SIZE
AU-TU1060	5 PCS

- Flexible ratchet handle for flexible working
- Extension bar to reach deep position
- High corrosion resistance

SIZE	CONTENT	WEIGHT (gr)	QTY / BOX INNER/MASTER
5 pcs	1 pcs 3/8" DR. Ratchet Handle Flexible	940	5 / 20 set
	1 pcs 3/8" Spark Plug Socket 16 mm		
	1 pcs 3/8" Spark Plug Socket 21 mm		
	1 pcs 3/8" DR. Extension Bar 5"		
	1 pcs 3/8" DR. Extension Bar 8"		



TIRE PRESSURE GAUGE

ALAT PENGISI ANGIN BAN 3 FUNGSI

ITEM CODE	SIZE	1 (mm)	2 (mm)	3 (mm)	4 (mm)	5 (mm)	6 (mm)	WEIGHT (gr)	QTY / BOX INNER/MASTER
AU-PG1405	200 psi	125	11	75	13	12	515	450	5 / 40 pcs

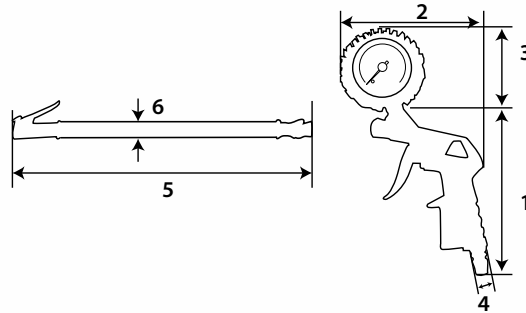

- Ergonomic handle
- Flexible & high pressure hose
- Material Chrome vanadium



TIRE PRESSURE GAUGE

ALAT UKUR TEKANAN ANGIN BAN (BULAT)

ITEM CODE	SIZE	1 (mm)	2 (mm)	WEIGHT (gr)	QTY / BOX INNER/MASTER
AU-TG1670	60 psi	48	100	113	10 / 100 pcs

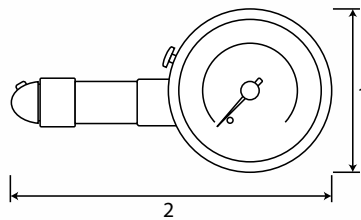

- Angle chuck model
- Large dial for easy to read
- Suitable for most tire



PRESSURE GAUGE

ALAT UKUR TEKANAN ANGIN KOMPRESOR

ITEM CODE	SIZE	1 (mm)	2 (mm)	3 (mm)	WEIGHT (gr)	QTY / BOX INNER/MASTER
AU-PG1395	2.5 bar	61	26	12	109	10 / 100 pcs
AU-PG0986	4 bar	61	28	13	120	10 / 100 pcs
AU-PG0987	6 bar	61	28	13	120	10 / 100 pcs
AU-PG0988	10 bar	61	28	13	120	10 / 100 pcs
AU-PG0989	16 bar	61	28	13	120	10 / 100 pcs
AU-PG0990	25 bar	61	28	13	120	10 / 100 pcs

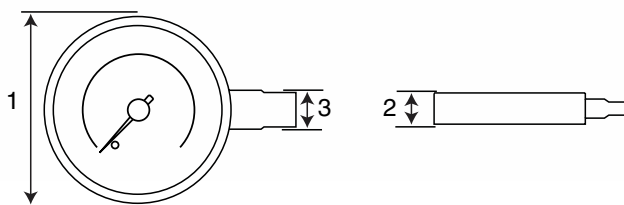

- Double standard air pressure
- Glass cover
- Measuring air pressure in application compressor





WWW.TEKIRO.COM

HYDRAULIC FLOOR JACK

The **TEKIRO** Hydraulic Floor Jack is heavy duty and designed to meet the demanding lifting needs of the professional service technician. Features include high-quality material, flanged side plates for strength, powder coat paint, and a safety overload valve for added protection. These are some of the strongest and most durable floor jacks in the industry.



Nylon Wheel for quiet positioning



Glide-action pressure pump is designed to lift with minimal effort

Internal Safety Overload Valve

360 degree swivel casters for easy mobility

Powder Coated Paint, High resistant to corrosion

Complies with
ASME
Safety Standards



SPECIAL QUALITY DESIGN

Polished and treated cylinder rams use high performance seals.

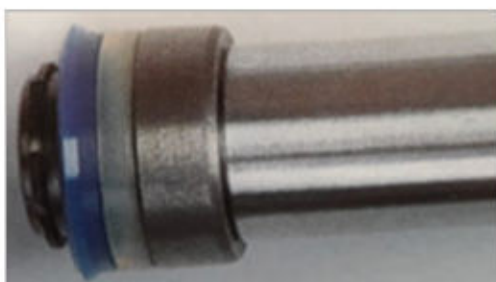

Polished inner cylinder walls extend the life of the seals to minimize abrasion and wear.

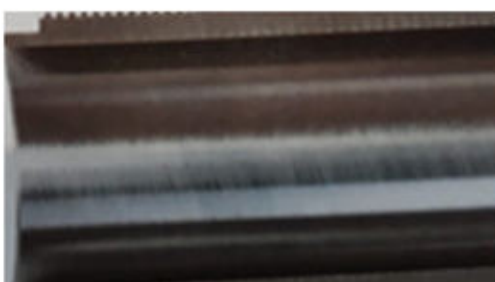

HYDRAULIC FLOOR JACK 2 TON 360°

Carry Handle for easy movement (360 degree)



- Safety valve to prevent overload
- 360° rotating castors
- Heavy duty rotating saddle
- Durable nylon casters for low noise

HYDRAULIC FLOOR JACK WITH CASE 2 TON

DONGKRAK BUAYA 2 TON (SPEC 2)

ITEM CODE	SIZE	1 (mm)	2 (mm)	3 (mm)	4 (mm)	5 (mm)	6 (mm)	7 (mm)	WEIGHT (gr)	QTY / BOX INNER/MASTER
AU-FJ0994	2 ton	440	200	135	52	135 - 342	458	335	8,177	1 / 1 pcs

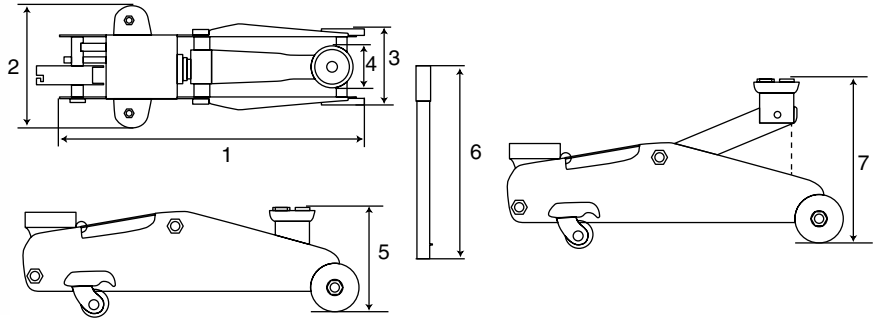

- Safety valve to prevent overload
- Heavy duty rotating saddle
- Durable nylon castors for low noise
- 360° handle to use at any angle

HYDRAULIC FLOOR JACK 2 TON 360°

DONGKRAK BUAYA 2 TON PUTAR 360°

ITEM CODE	SIZE	1 (mm)	2 (mm)	3 (mm)	4 (mm)	5 (mm)	6 (mm)	7 (mm)	WEIGHT (gr)	QTY / BOX INNER/MASTER
AU-FJ0995	2 ton	440	200	135	52	135 - 335	458	335	8,274	1 / 1 pcs

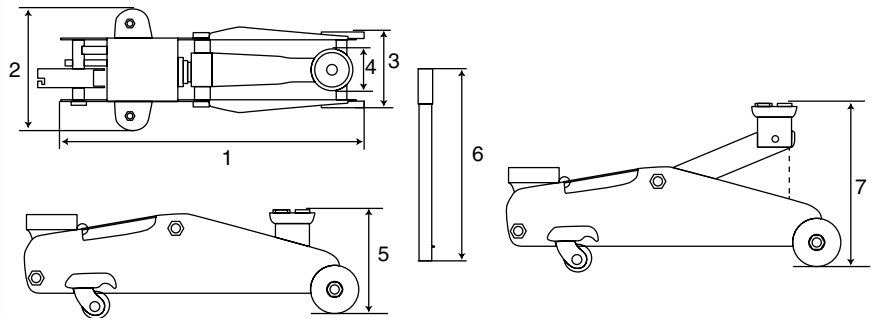

- Wide bowl for stability
- Foot pump for high speed lifting
- Safety valve to prevent Over load

HEAVY DUTY HYDRAULIC FLOOR JACK

DONGKRAK BUAYA PANJANG

ITEM CODE	SIZE	1 (mm)	2 (mm)	3 (mm)	4 (mm)	5 (mm)	6 (mm)	7 (mm)	8 (mm)	WEIGHT (gr)	QTY / BOX INNER/MASTER
AU-FJ0997	3 ton	1,140	300	235	78	300	110	89	560	34,000	1 / 1 pcs
AU-FJ0998	5 ton	1,301	360	270	130	300	110	109	560	87,000	1 / 1 pcs
AU-FJ0999	10 ton	1,360	480	320	180	370	170	141	560	133,000	1 / 1 pcs

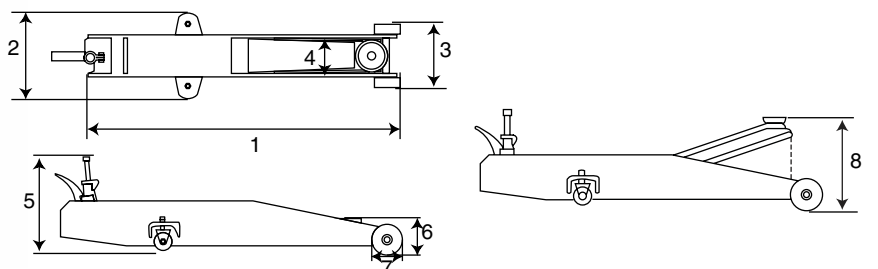

HYDRAULIC JACK DOUBLE PUMP LOW PROFILE 3 TON

DONGKRAK BUAYA 3 TON CEPER (DOUBLE PUMP)

ITEM CODE	SIZE	1 (mm)	2 (mm)	3 (mm)	4 (mm)	5 (mm)	6 (mm)	7 (mm)	WEIGHT (gr)	QTY / BOX INNER/MASTER
AU-FJ1677	3 ton	650	330	253	109	60	42.3	528	3,400	1 / 1 pcs

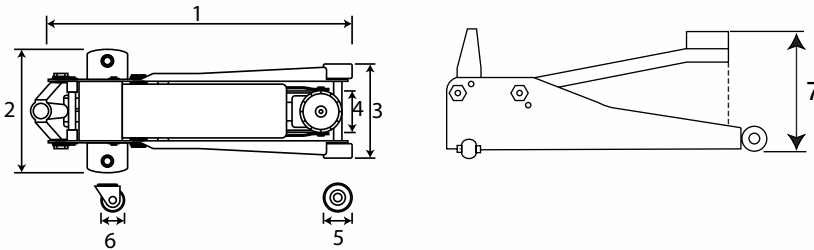

- Built for heavy duty professional use
- Dual pump mechanism for quick lifting
- Steel castors for durability
- Low profile 75mm, works for most vehicles with 3 1/2" ground clearance
- Wide bowl for stability



SCISSORS JACK 2 TON

DONGKRAK JEMBATAN 2 TON

ITEM CODE	SIZE	1 (mm)	2 (mm)	3 (mm)	4 (mm)	5 (mm)	6 (mm)	WEIGHT (gr)	QTY / BOX INNER/MASTER
AU-SJ1059	2 ton	440	68	165	29	60	560	3,360	1 / 6 pcs

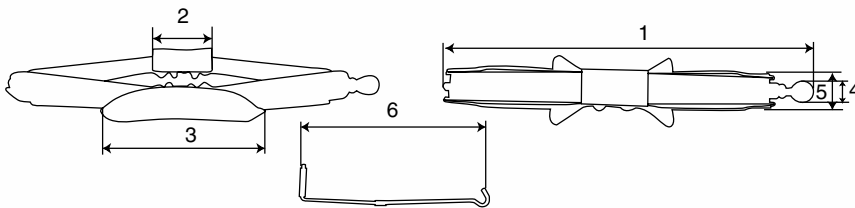

- Thread rod is integral rod
- Arms have teeth design increase stabilization
- Handle is riveted together can be folded, easy to carry
- Comes with handle



STEEL ALUMINUM FLOOR JACK DOUBLE PUMP 1.5 TON

DONGKRAK JEMBATAN 2 TON

ITEM CODE	SIZE	1 (mm)	2 (mm)	3 (mm)	4 (mm)	WEIGHT (gr)	QTY / BOX INNER/MASTER
AU-FJ1922	1.5 ton	498	238	198	365	1454	1 / 1 pcs

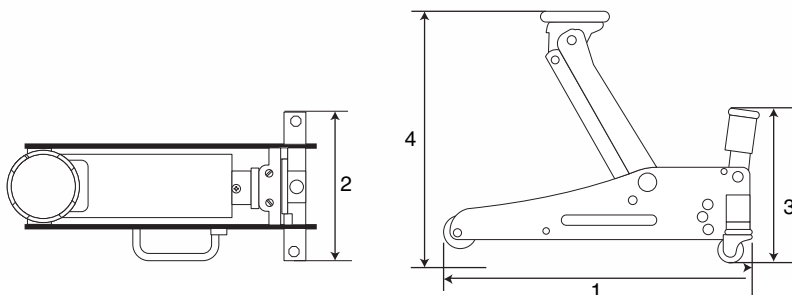

- Thread rod is integral rod
- Arms have teeth design increase stabilization
- Handle is riveted together can be folded, easy to carry
- Comes with handle



BOTTLE JACK

TEKIRO Hydraulic Welded Bottle Jack is designed for commercial use in various industries such as automotive, marine, construction, manufacturing and agriculture. The inner and outer welded structure and steel construction keeps it leak-free and give it an overall stronger build.

Complies with
ASME
Safety Standards



Steel lifting saddle engineered to hold load securely

Welded Design to prevent leakage & extends service life

Simple Handle

Hot forged base creates consistency and reduces oil contamination

Lowering Valve

Extension screw adjusts to accommodate desired work height

Powder Coating with high adhesion and corrosion resistance

Glide-action pressure pump is designed to lift with minimal effort

Welded Design to prevent leakage & extends service life

Internal Safety Overload Valve



HIGH GRADE STEEL

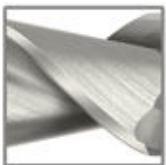

Constructed of high-grade steel and built to exacting standards for quality & durability.

HIGH QUALITY HYDRAULIC OIL



Hydraulics is powered with high quality oil, which offers better corrosion resistance and high/low-temperature flexibility, allowing the unit to operate at a temperature between 4°C and 40°C.

SAFETY INSTRUCTION



1. Lift the load using a bottle jack



2. After the load is lifted, hold it with a jack stand for safety on work and longer service life of bottle jack

HYDRAULIC WELDED BOTTLE JACK DOUBLE RAM

This is the extension of the Tekiro Welded Bottle Jack range. With double ram, the lifting height could be increased significantly

Adjustable Height
to accommodate desired work height

Double Ram
Increases the lifting height significantly

Welded Design
prevent leakage & extends service life

Powder Coating
high adhesion and corrosion resistance

Polyurethane Seal
For durable use and long life



TEKIRO
HAND TOOLS
RELIEVE IN YOUR CHOICE

1 HYDRAULIC WELDED BOTTLE JACK DOUBLE RAM
PL 10 TON

WARNING

- Never exceed the jack's rated load capacity.
- Base of jack should always rest on a firm, level surface.
- Never work under the load being lifted. Additional support devices are required.
- Do not tamper with pressure adjusting valve screw. This is safety pin.

CE

- High durable hardness
- Quick lifting weight
- Stable lifting

HYDRAULIC WELDED BOTTLE JACK

DONGKRAK BOTOL -1

ITEM CODE	SIZE	1 (mm)	2 (mm)	3 (mm)	4 (mm)	5 (mm)	6 (mm)	7 (mm)	WEIGHT (gr)	QTY / BOX INNER/MASTER
AU-BJ1909	2 ton	333	105	180	13	48	22	5	2,140	1 / 6 pcs
AU-BJ1910	4 ton	370	120	190	17	60	27	5	2,750	1 / 6 pcs
AU-BJ1911	6 ton	420	140	210	19	70	32	6	3,660	1 / 4 pcs
AU-BJ1912	10 ton	460	150	230	29	75	34	6	4,700	1 / 4 pcs
AU-BJ1913	15 ton	470	155	235	32	95	48	7	7,080	1 / 2 pcs
AU-BJ1914	20 ton	460	160	240	35	111	53	7	8,600	1 / 2 pcs
AU-BJ1915	30 ton	430	170	260	0	139	71	22	17,890	1 / 1 pcs
AU-BJ1916	50 ton	470	190	280	0	156	85	22	25,350	1 / 1 pcs

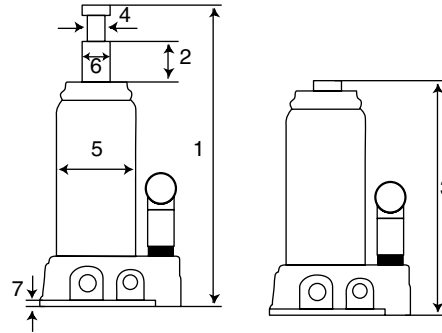

- High durable hardness
- Quick lifting weight
- Stable lifting

HYDRAULIC JACK

DONGKRAK BOTOL

ITEM CODE	SIZE	1 (mm)	2 (mm)	3 (mm)	4 (mm)	5 (mm)	6 (mm)	7 (mm)	WEIGHT (gr)	QTY / BOX INNER/MASTER
AU-BJ1009	100 ton	540	215	325	100	115	230	55	87,000	1 / 1 pcs

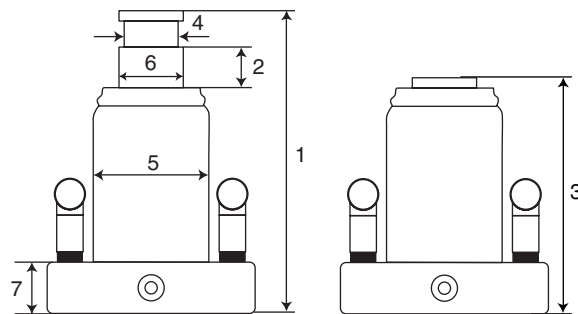

HYDRAULIC WELDED BOTTLE JACK DOUBLE RAM

DONGKRAK BOTOL TIPE 2 RAM

ITEM CODE	CAPACITY	1 (mm)	2 (mm)	3 (mm)	4 (mm)	5 (mm)	6 (mm)	7 (mm)	WEIGHT (gr)	QTY / BOX INNER/MASTER
AU-BJ1917	2 ton	380	215	165	22	28	60	0	2,600	1 / 6 pcs
AU-BJ1918	4 ton	360	200	170	27	34	70	60	3,360	1 / 4 pcs
AU-BJ1919	6 ton	430	210	170	35	43	85	60	4,700	1 / 4 pcs
AU-BJ1920	8 ton	430	210	180	35	43	85	60	4,700	1 / 4 pcs
AU-BJ1921	10 ton	390	210	175	43	54	106	60	7,650	1 / 2 pcs

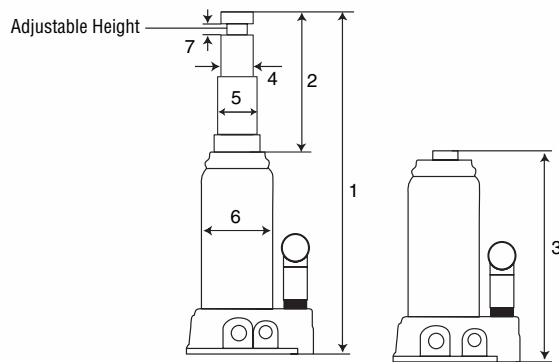

DOUBLE LOCKING JACK STAND

TAHANAN DONGKRAK

ITEM CODE	SIZE	1 (mm)	2 (mm)	3 (mm)	4 (mm)	5 (mm)	6 (mm)	7 (mm)	WEIGHT (gr)	QTY / BOX INNER/MASTER
AU-JS1010	3 ton	288	423	210	64	270	35	26	6,930	1 / 4 pcs
AU-JS1011	6 ton	400	615	290	70	365	40	29	130,003	1 / 1 pcs

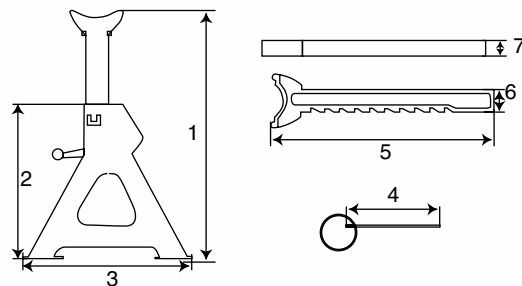

- Large feet area & large saddle for stability
- Double locking protection for safety



- Made of High quality steel
- Fine threaded barrel
- Cap fitted with nylon seal, for greater pressure and prevent leaks
- Comes with 2 hoses (flexible and steel) and one extra nylon seal

HIGH PRESSURE GREASE GUN 6000 PSI 500 CC

POMPA GEMUK 500 CC

ITEM CODE	SIZE	1 (mm)	2 (mm)	3 (mm)	4 (mm)	5 (mm)	6 (mm)	7 (mm)	8 (mm)	WEIGHT (gr)	QTY / BOX INNER/MASTER
AU-GG1015	500 cc	379	58	17	266	68	90	170	330	1,501	1 / 12 pcs

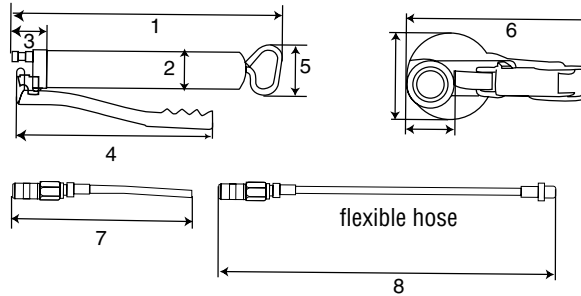

- Small size, high pressure
- Special coupler

HIGH PRESSURE GREASE GUN

POMPA GEMUK 100 CC

ITEM CODE	SIZE	1 (mm)	2 (mm)	3 (mm)	4 (mm)	5 (mm)	6 (mm)	7 (mm)	WEIGHT (gr)	QTY / BOX INNER/MASTER
AU-GG1014	100 cc	217	32	45	182	59	36	15	454	1 / 36 pcs

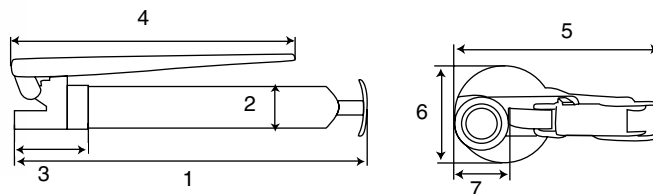

- 1/2" Flexible hose 4500 psi
- 4 jaws coupler to fit strongly

HOSE HAND GREASE GUN

SELANG POMPA GEMUK SET 6 PCS

ITEM CODE	SIZE	1 (mm)	2 (mm)	3 (mm)	4 (mm)	5 (mm)	6 (mm)	WEIGHT (gr)	QTY / BOX INNER/MASTER
AU-HG1369	6 PCS	330	31	9	7	13	40	549	1 / 30 pcs

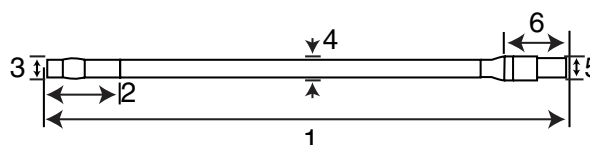

GREASE PUMP

POMPA GEMUK 20 L

- Wheel and handle for easy handling
- Ergonomic pump handle
- Flexible hose and gun for easy use

ITEM CODE	SIZE	1 (mm)	2 (mm)	3 (mm)	4 (mm)	5 (mm)	6 (mm)	7 (mm)	8 (mm)	WEIGHT (gr)	QTY / BOX INNER/MASTER
AU-GP1012	20 L	780	295	440	150	430	16	455	1,470	10,000	1 set

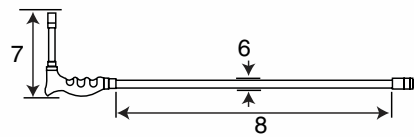
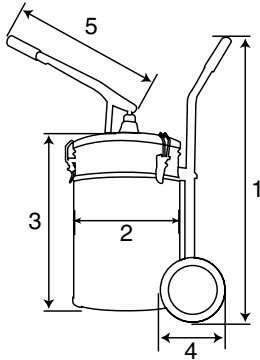

OIL PUMP 20 L

POMPA OLI 20 L

- Big volume storage tank
- Easy to re - fill the oil

ITEM CODE	SIZE	1 (mm)	2 (mm)	3 (mm)	4 (mm)	5 (mm)	6 (mm)	7 (mm)	WEIGHT (gr)	QTY / BOX INNER/MASTER
AU-OP1013	20 L	780	295	440	150	430	18	1,500	800	1 set

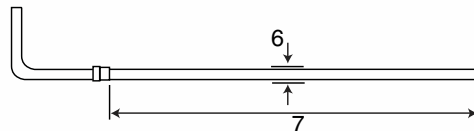
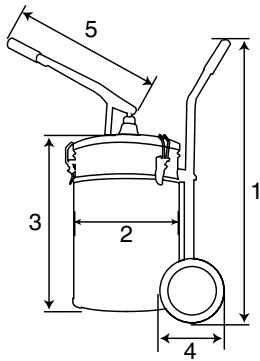

OIL SUCTION GUN

POMPA OLI

- Deluxe lip seal for maximum suction
- 12° flexible delivery tube

ITEM CODE	SIZE	1 (mm)	2 (mm)	3 (mm)	4 (mm)	5 (mm)	6 (mm)	7 (mm)	WEIGHT (gr)	QTY / BOX INNER/MASTER
AU-SG1016	500 cc	289	60	55	245	318	34	14	148	1 / 20 pcs
AU-SG1291	1,000 cc	400	60	50	245	335	32	13	1,078	1 / 12 pcs

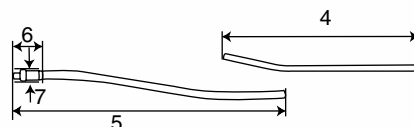
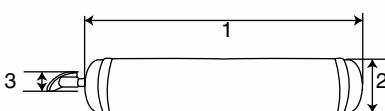

AUTOMOTIVE

STORAGE

TRAY

AIR TOOLS

HEX KEY

GENERAL TOOLS

- Material chrome vanadium
- Drop forged and properly heat-treated for super durability

TYRE WRENCH

CONGKELAN BAN

ITEM CODE	SIZE	1 (mm)	2 (mm)	WEIGHT (gr)	QTY / BOX INNER/MASTER
AU-RC1017	10"	254	19	193	12 / 120 pcs
AU-RC1018	12"	300	22	195	12 / 48 pcs

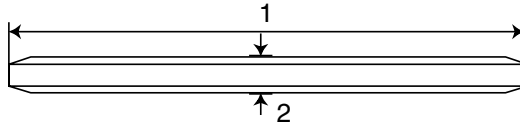

- Heavy spring steel compresses the piston rings evenly
- Positive lock action provides positive compression and fingertip release

PISTON RING COMPRESSOR

POMPA GEMUK MINI TANGAN

ITEM CODE	SIZE	1 (mm)	2 (mm)	3 (mm)	4 (mm)	WEIGHT (gr)	QTY / BOX INNER/MASTER
AU-PC1446	3" X 57 - 125 mm	67	75	6	90	322	20 / 60 pcs
AU-PC1447	4" X 90 - 175 mm	69	110	6	90	294	10 / 60 pcs

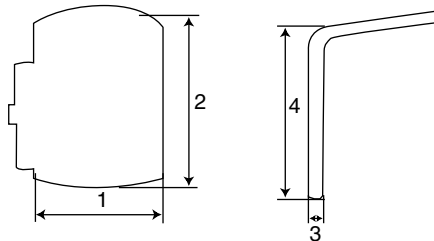

- Material Chrome Vanadium
- Design to magnetic uninstall
- Simple structure and easy to use
- High durable and corrosion resistance

FLYWHEEL PULLER

TREKER MAGNET MULTI FUNGSI

ITEM CODE	SIZE	1 (mm)	2 (mm)	3 (mm)	4 (mm)	5 (mm)	6 (mm)	WEIGHT (gr)	QTY / BOX INNER/MASTER
AU-MT1030	NO 1	34	34	92	8	118	33	394	10 / 40 pcs
AU-MT1031	NO 2	34	34	92	8	118	34	388	10 / 40 pcs
AU-MT1032	NO 3	36	28	91	9	119	36	391	10 / 40 pcs
AU-MT1033	NO 4	31	50	102	9	119	31	450	10 / 40 pcs

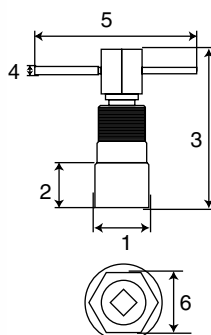

DESCRIPTION

- NO 1 = Honda (Kharisma, NSR, Tiger), Kawasaki (Ninja), Yamaha (RX), Suzuki (Satria, RC, Thunder 125)
- NO 2 = Honda (C7--, KC, GL, Grand, Tiger), Yamaha (RX-K, RX-S, RX-Z, Mio, Nouvo), Suzuki (GTO, RS, RGR, Satria F 150, Shogun)
- NO 3 = Yamaha (Alfa, Champ, Force 1)
- NO 4 = Honda (Neotech, Tiger), Suzuki (RC), Yamaha (RX)



AUTOMOTIVE

STORAGE

TRAY

AIR TOOLS

HEX KEY

GENERAL TOOLS

- High Quality Resin
- Smooth quality castors
- cushion head rest

MECHANICAL CREEPER TRH 6802

ALAS KERJA MEKANIK

ITEM CODE	SIZE	1 (mm)	2 (mm)	3 (mm)	4 (mm)	5 (mm)	6 (mm)	7 (mm)	WEIGHT (gr)	QTY / BOX INNER/MASTER
AU-MC1019	100 X 46 cm	1,000	470	200	85	450	25	47	4,900	1 pcs

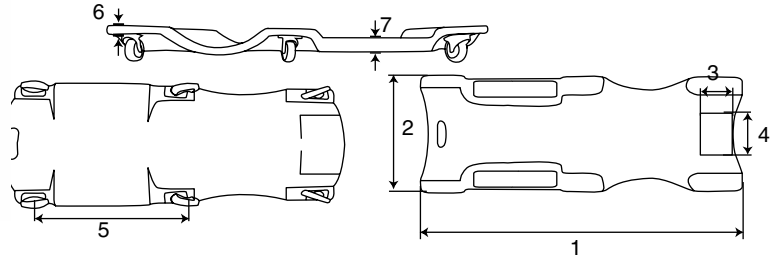

- Suitable for use on all vehicle types and models
- Easily and quickly separates disc brake
- Simple on-hand installation

DISC BRAKE SPREADER

TREKER REM MOBIL

ITEM CODE	SIZE	1 (mm)	2 (mm)	3 (mm)	4 (mm)	5 (mm)	6 (mm)	WEIGHT (gr)	QTY / BOX INNER/MASTER
AU-DB1034	15.2 X 7.3 X 2.1 cm	153	114	9	5	6	12	750	1 / 24 pcs

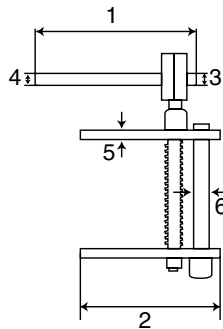

- Heat treated alloy steel
- Drop forged for extra strength
- High durable hardness

BALL JOINT SEPARATOR

TREKER BALL JOINT

ITEM CODE	SIZE	1 (mm)	2 (mm)	3 (mm)	WEIGHT (gr)	QTY / BOX INNER/MASTER
AU-BJ1036	9"	159	92	31	1,270	1 / 20 pcs

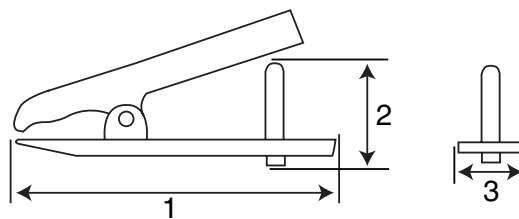

COIL SPRING COMPRESSOR SINGLE JAW

TREKER PER MOBIL - SATU KAKI / TREKER PER KEONG

ITEM CODE	SIZE	1 (mm)	2 (mm)	3 (mm)	WEIGHT (gr)	QTY / BOX INNER/MASTER
AU-CS1038	400 mm	450	32	20	2,160	1 / 10 set

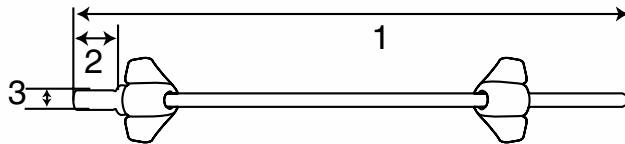

- Single jaw for fast and secure installation on coil springs
- Suitable for use where space under wheel arch is limited



COIL SPRING CLAMP DOUBLE JAWS

TREKER PER MOBIL - DUJ KAKI / TREKER PER KEONG

ITEM CODE	SIZE	1 (mm)	2 (mm)	3 (mm)	WEIGHT (gr)	QTY / BOX INNER/MASTER
AU-CS1039	400 mm	451	31	21	2254	1 / 10 set

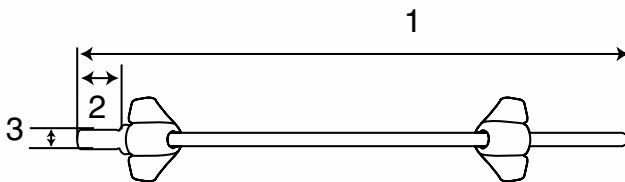

- Double wrap over coil claw design for extra safety
- Suitable for use where space under wheel arch is limited



UNIVERSAL HOLDER

KUNCI TAHANAN KOPLING

ITEM CODE	SIZE	1 (mm)	2 (mm)	3 (mm)	4 (mm)	WEIGHT (gr)	QTY / BOX INNER/MASTER
AU-UH1040	33 X 22 cm	330	123	64	19	481	12 / 36 pcs

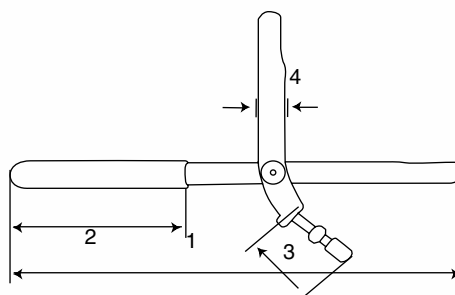

- Material Chrome Vanadium



• Material Chrome Molybdenum

CLUTCH SPRING CHECK TOOL

TAHANAN RUMAH KOPLING MATIC



ITEM CODE	SIZE	1 (mm)	2 (mm)	3 (mm)	4 (mm)	5 (mm)	6 (mm)	WEIGHT (gr)	QTY / BOX INNER/MASTER
AU-CP1041	125 - 155 mm	135	20	109	167	83	35	1,470	6 / 24 pcs

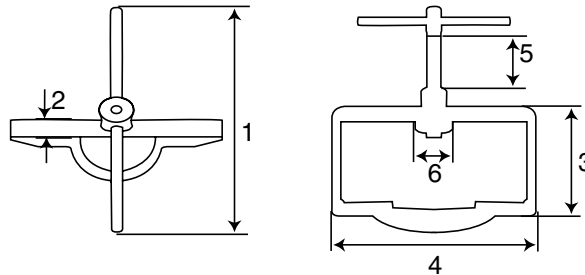

• Material Chrome Molybdenum

HEAVY DUTY ADJUSTING CRANK TOOL SET 8 PCS

TREKER RUMAH MESIN MOTOR SET 8 PCS



ITEM CODE	SIZE	1 (mm)	2 (mm)	3 (mm)	4 (mm)	5 (mm)	6 (mm)	7 (mm)	8 (mm)	9 (mm)	WEIGHT (gr)	QTY / BOX INNER/MASTER
AU-CR1042	8 pcs	148	~	200	~	~	94	65	57	48	1,500	1 / 12 pcs

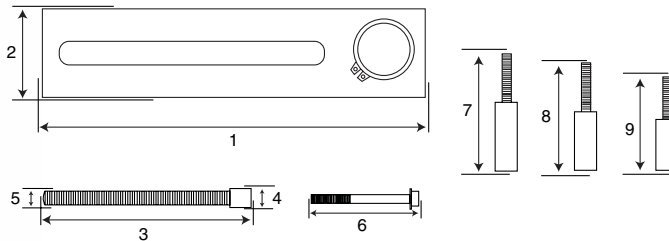

- Material Chrome Molybdenum
- Specifically for small Engine applications
- Easily for replacing valve spring
- Suitable for different valve size

HEAVY DUTY VALVE SPRING COMPRESSOR

TREKER KLEP MESIN SET 6 PCS



ITEM CODE	SIZE	1 (mm)	2 (mm)	3 (mm)	4 (mm)	5 (mm)	6 (mm)	WEIGHT (gr)	QTY / BOX INNER/MASTER
AU-SC1043	19 mm ~ 16.5 mm	47	244	108	25	130	50	1,235	1 / 12 set
	23 mm ~ 21.5 mm	47	244	108	25	130	50	1,235	
	25 mm ~ 23.5 mm	47	244	108	25	130	50	1,235	

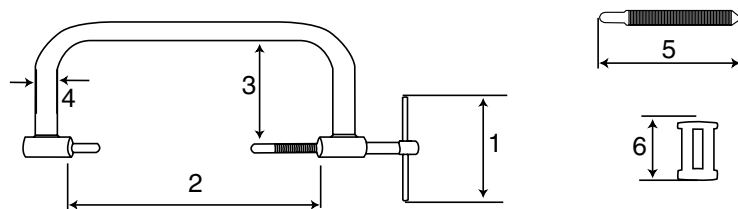

BEARING PULLER

TREKER BEARING

ITEM CODE	SIZE	1 (mm)	2 (mm)	3 (mm)	4 (mm)	WEIGHT (gr)	QTY / BOX INNER/MASTER
AU-BP1044	AB 1	87	56	70	54	280	10 / 50 pcs
AU-BP1045	AB 2	107	83	131	78	677	10 / 30 pcs

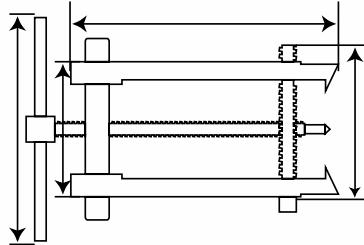

- Easy to remove bearings
- Fully adjustable jaws
- Suitable for multiple bearings
- Molybdenum materials



BLIND BEARING PULLER SET 5 PCS

TREKER AS RODA (MOTOR) SET 5 PCS

ITEM CODE	SIZE	1 (mm)	2 (mm)	WEIGHT (gr)	QTY / BOX INNER/MASTER
AU-BB1851	5pcs	390	12	2,480	1 / 10 pcs

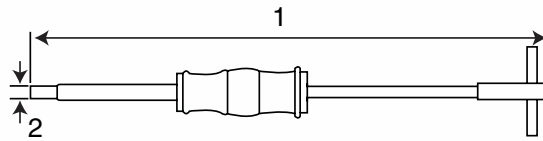

- Long slide chrome finish
- Chrome molybdenum extractor
- High durable hardness



TWO ARM GEAR PULLER

TREKER KAKI DUA

ITEM CODE	SIZE	1 (mm)	2 (mm)	3 (mm)	4 (mm)	WEIGHT (gr)	QTY / BOX INNER/MASTER
AU-AP1047	3"	100	75	10	6	227	1 / 60 pcs
AU-AP1048	4"	123	100	13	8	360	1 / 50 pcs
AU-AP1049	6"	171	150	17	10	810	1 / 30 pcs
AU-AP1050	8"	245	200	18	12	1,900	1 / 12 pcs
AU-AP1051	10"	325	250	25	18	3,700	1 / 6 pcs
AU-AP1052	12"	360	300	29	22	5,880	1 / 4 pcs

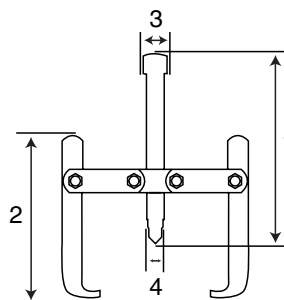

- Suitable for pulling hubs, flanges, gears, bearings as reduction type starter motor powertools, etc
- Made from High-Strength forged and hardened steel 2 jaws design



- Suitable for pulling hubs, flanges, gears, bearings as reduction type starter motor powertools, etc
- Made from High-Strength forged and hardened steel 3 jaws design



THREE ARM GEAR PULLER

TREKER KAKI TIGA

ITEM CODE	SIZE	1 (mm)	2 (mm)	3 (mm)	4 (mm)	WEIGHT (gr)	QTY / BOX INNER/MASTER
AU-AP1053	3"	100	75	11	7	320	1 / 60 pcs
AU-AP1054	4"	123	100	13	8	485	1 / 40 pcs
AU-AP1055	6"	171	150	17	10	1,100	1 / 20 pcs
AU-AP1056	8"	245	200	19	13	2,600	1 / 8 pcs
AU-AP1057	10"	320	250	25	18	4,980	1 / 4 pcs
AU-AP1058	12"	360	300	29	23	7,500	1 / 3 pcs

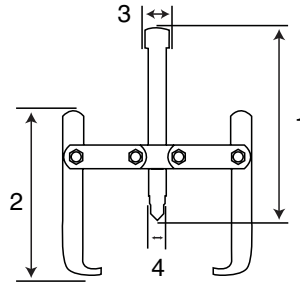

- Easy to disconnect roller chain
- Metal body for high durability
- Suitable for motorcycle and bicycle chain



ROLLER CHAIN DETACHERS

PEMOTONG RANTAI

ITEM CODE	SIZE	1 (mm)	2 (mm)	3 (mm)	4 (mm)	WEIGHT (gr)	QTY / BOX INNER/MASTER
AU-CR1046	25 - 60	63	98	44	135	280	25 / 50 pcs

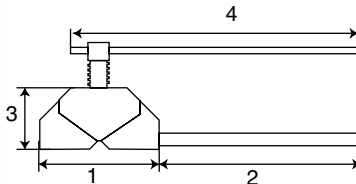

- Blow mould case
- Easy to bring
- High durable hardness



BEARING SEPARATOR SET

TREKER BEARING SEPARATOR SET 12 PCS

ITEM CODE	CONTENT	WEIGHT (gr)	QTY / BOX INNER/MASTER
AU-SS1402	2 pcs Bearing Separator Capacity 30 x 50 mm (1 1/4" - 2 1/2")	4,690	1 / 5 set
	Capacity 50 x 75 mm (2 1/4" - 3 1/2")		
	2 pcs 17 X L127 mm Extention Screw (Male & Female Threads)		
	2 pcs 17 X L127 mm Extention Screw (Male Threads)		
	2 pcs 17 X L103 mm Extention Screw (Male & Female Threads)		
	2 pcs 17 X L103 mm Extention Screw (Male Threads)		
	1 pcs 6" Bar - Type Puller Yoke		
	1 pcs Forcing Screw 9/16" X L175 mm		

FLANGE AXLE AND JAW PULLER SET

TREKER AS RODA (MOBIL) SET 18 PCS

- Blow mould case
- Easy to bring
- High durability

ITEM CODE	CONTENT	WEIGHT (gr)	QTY / BOX INNER/MASTER
AU-UA1403	3 pcs Internal / External Puller Jaws	7,697	1 / 2 set
	3 pcs Screws and Nuts		
	2 pcs Flange Axle Puller (Shallow & Deep)		
	1 pcs Heavy - Duty Slide Hammer		
	1 pcs Center Bolt And T - Bar		
	1 pcs 2 - Way Puller Cross Head		
	1 pcs 3 - Way Puller Cross Head		
	1 pcs Jaw Spreader Cone		
	1 pcs Puller Hook Adapter		
	1 pcs Locking Plier Adapter		
	1 pcs Dent Puller Screw Adapter		
	1 pcs Tapping Screw		
	1 pcs Forcing Screw 5/8" x L145 mm		



OIL CAN METAL

POMPA OLI BOTOL 500 ML

- Flexible hose
- Ergonomic design
- Strong metal can

ITEM CODE	SIZE	1 (mm)	2 (mm)	3 (mm)	4 (mm)	5 (mm)	WEIGHT (gr)	QTY / BOX INNER/MASTER
AU-OC1414	500 ml	55	87	154	38	165	184	1 / 80 pcs

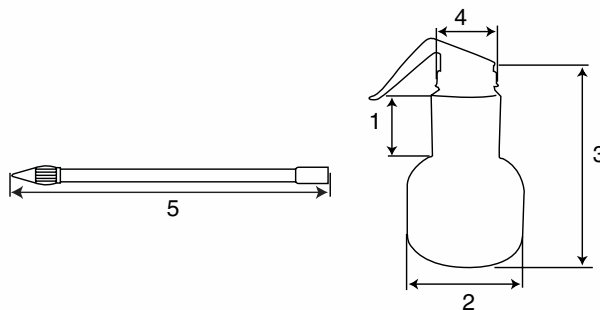

GUN AIR LUBRICATOR

ALAT TEMBAK GEMUK

- Chrome vanadium plated finish
- Corrosion resistance

ITEM CODE	SIZE	1 (mm)	2 (mm)	3 (mm)	4 (mm)	5 (mm)	6 (mm)	WEIGHT (gr)	QTY / BOX INNER/MASTER
AU-GL1587	6"	284	24	48	170	9	14	949.0	1 / 20 pcs

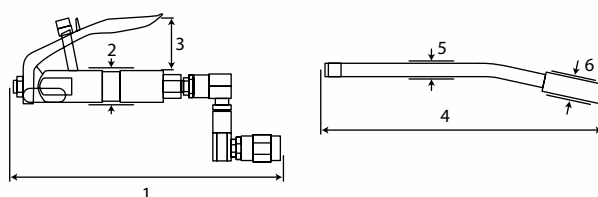

- Evacuates all type of fluid
- Suitable for most vehicles
- Polyethylene construction for durable use



COMBO FLUID EXTRUDER

POMPA OLI KOMBINASI 10 L

ITEM CODE	SIZE	1 (mm)	2 (mm)	3 (mm)	4 (mm)	5 (mm)	6 (mm)	WEIGHT (gr)	QTY / BOX INNER/MASTER
AU-CF1697	10 L	540	272	320	402	33	1,200	4,600	1 / 4 pcs

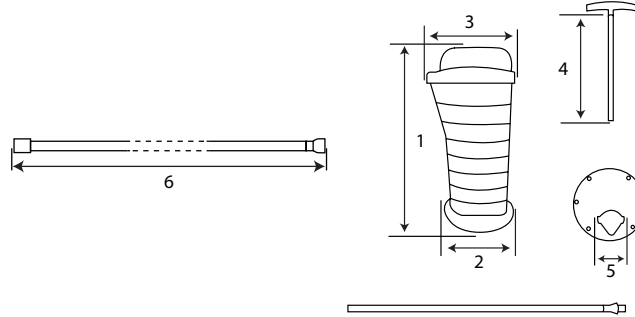

- High quality plastic
- Easy to use
- High durable



VACUUM BRAKE FLUID BLEEDER

ALAT KURAS MINYAK REM 1 L

ITEM CODE	SIZE	1 (mm)	2 (mm)	3 (mm)	4 (mm)	5 (mm)	6 (mm)	WEIGHT (gr)	QTY / BOX INNER/MASTER
AU-VB1585	1 L	121	130	53	230	6	1,060	421.59	1 / 20 pcs

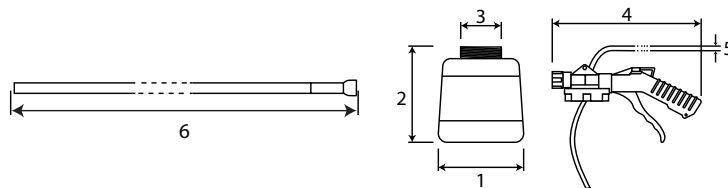

- High quality plastic
- Easy to use
- High durable



UNIVERSAL VACUUM BRAKE FLUID BLEEDER SET

ALAT KURAS & ISI MINYAK REM 1L SET

ITEM CODE	SIZE	1 (mm)	2 (mm)	3 (mm)	4 (mm)	5 (mm)	6 (mm)	7 (mm)	8 (mm)	WEIGHT (gr)	QTY / BOX INNER/MASTER
AU-VB1586	1 L	121	130	53	230	6	214	70	1,060	540.5	1 / 20 pcs

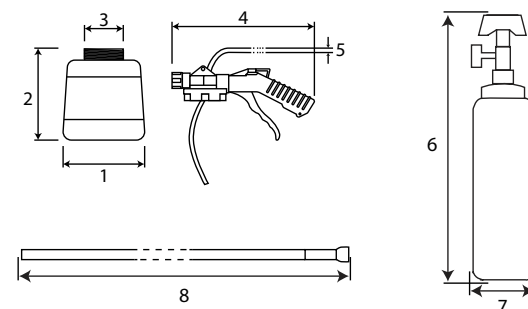

TIRE SEAL STRING

OBAT TAMBAL BAN

ITEM CODE	SIZE	1 (mm)	WEIGHT (gr)	QTY / BOX INNER/MASTER
AU-TS1722	5pcs	202	208	1 / 24 pcs

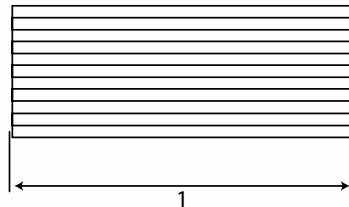

- High quality vulcanized rubber strip
- Closely fits tires
- For quick repairs
- To be used with other tire repair tools



TYRE KIT METAL

ALAT TUBLES BAN SET GAGANG BESI

ITEM CODE	SIZE	1 (mm)	2 (mm)	3 (mm)	4 (mm)	5 (mm)	6 (mm)	WEIGHT (gr)	QTY / BOX INNER/MASTER
AU-TK1774	90	18	120	83	8	4	~	~	10 / 40 pcs

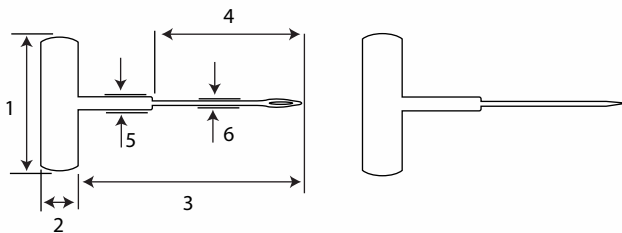

- Emergency Vehicles Puncture Repair Kit for Tubeless Tires
- Mend punctures quickly and effectively
- Metal Handles for durability
- This Rasper Tool allows Tire hole widening and cleaning
- Needle Tool allows Tyre Rubber Strip insertion
- Includes 5 Repair Rubber Strips
- Useful Tool to keep in the car with spare wheels



TYRE KIT PLASTIC

ALAT TUBLES BAN SET GAGANG PLASTIK

ITEM CODE	SIZE	1 (mm)	2 (mm)	3 (mm)	4 (mm)	5 (mm)	6 (mm)	WEIGHT (gr)	QTY / BOX INNER/MASTER
AU-TK1775	4mm	100	42	95	78	15	4	196	4 / 48 pcs

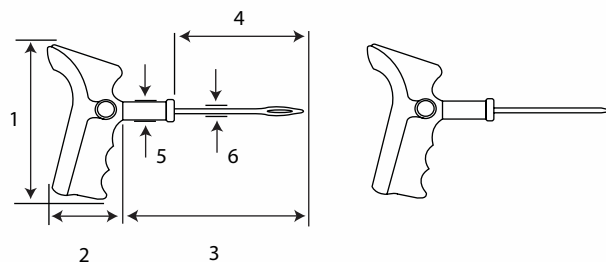

- Emergency Vehicles Puncture Repair Kit for Tubeless Tires
- Mend punctures quickly and effectively
- Plastic Handle for extra comfort o This Rasper Tool allows Tire hole widening and cleaning
- Needle Tool allows Tyre Rubber Strip insertion
- Includes 5 Repair Rubber Strips
- Useful Tool to keep in the car with spare wheels



- High durable hardness
- Width thickness
- Material chrome vanadium
- Nice grip on handle
- Ideal for the lining of doors, backdoors, quarter panels floor, etc

SET DOOR UPHOLSTERY PANEL REMOVER SET 2 PCS

KUNCI PEMBUKA PANEL PINTU SET 2 PCS

ITEM CODE	SIZE	1 (mm)	2 (mm)	3 (mm)	4 (mm)	5 (mm)	6 (mm)	7 (mm)	WEIGHT (gr)	QTY / BOX INNER/MASTER
AU-PP1506	6mm	240	120	34	28	5	6	13	116	6 / 48 pcs

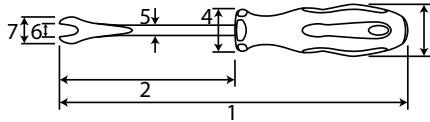

ITEM CODE	SIZE
AU-MT0978	45 PCS

MECHANIC TOOLS 45 PCS

MEKANIK TOOLS SET 45 PCS



SIZE	CONTENT	WEIGHT (gr)	QTY / BOX INNER/MASTER
45 pcs	9 pcs Socket 10 mm, 12 mm, 13 mm, 14 mm, 17 mm 19 mm, 21 mm, 22 mm, 24 mm	8,751	1 set
	1 pcs 1/2" DR. Spark Plug 21 mm		
	1 pcs 1/2" DR. Flexible Handle 15"		
	1 pcs 1/2" DR. Ratchet Handle 72 Teeth Rubber Handle 10"		
	1 pcs 1/2" DR. Extension Bar 5"		
	1 pcs Diagonal Plier 6"		
	1 pcs Long Nose Plier 6"		
	1 pcs Slip Joint Pliers 8"		
	1 pcs Water Pump Pliers 10"		
	1 pcs Ballpeen Hammer 6 OZ		
	6 pcs Open End Wrench 6 X 7 mm, 10 X 11 mm, 12 X 13 mm 12 X 14 mm, 14 X 17 mm, 17 X 19 mm		
	6 pcs Boxes End Wrench 10 X 11 mm, 12 X 13 mm, 12 X 14 mm 14 X 17 mm, 19 X 21 mm, 22 X 24 mm		
	11 pcs Go-Thru Screwdriver (+) PH0 X 75 mm (3.2) (+) PH1 X 75 mm (5) (+) PH2 X 38 mm (6) (+) PH2 X 100 mm (6) (+) PH3 X 150 mm (8) (-) 3.2 X 75 mm, (-) 5 X 75 mm (-) 6 X 38 mm, (-) 6 X 100 mm (-) 8 X 150 mm, (-) 8 X 200 mm		
	1 pcs Adjustable Wrench 8"		
	1 pcs Adjustable Wrench 12"		
	1 pcs File		
	1 pcs Metal Case		

MECHANIC TOOLS SET SM 59 PCS

MEKANIK TOOLS SET SM 59 PCS

ITEM CODE	SIZE
AU-MT0979	59 pcs

SIZE	CONTENT	WEIGHT (gr)	QTY / BOX INNER/MASTER
59 pcs	5 pcs Open end wrench 6 X 7 mm, 8 X 10 mm, 12 X 14 mm 17 X 19 mm, 22 X 24 mm	9,376	1 set
	4 pcs Box End Wrench 8 X 10 mm, 12 X 14 mm 17 X 19 mm, 22 X 24 mm		
	10 pcs 3/8" DR. Socket 8 mm, 10 mm, 12 mm, 14 mm, 17 mm 19 mm, 21 mm, 22 mm, 23 mm, 24 mm		
	1 pcs 3/8" DR. Ratchet Handle 72 Teeth Rubber Handle 8"		
	1 pcs 3/8" DR. Sliding T Bar 8"		
	1 pcs 3/8" DR. Extension Bar 6"		
	2 pcs 3/8" DR. Spark Plug 16 mm, 21 mm		
	8 pcs Go-Thru Screw Driver (+) PH1 X 75 mm, (+) PH2 X 38 mm (+) PH2 X 100 mm (+) PH3 X 150 mm (-) 5 X 75 mm, (-) 6 X 38 mm (-) 6 X 100 mm, (-) 8 X 150 mm		
	1 pcs Slip Joint Plier 8"		
	1 pcs Long Nose Plier 6"		
	1 pcs Diagonal Plier 6"		
	1 pcs Snap Ring 7" IS		
	1 pcs Snap Ring 7" ES		
	1 pcs Adjustable Wrench 10"		
	1 pcs Ball Pein Hammer with Fibre 8 OZ		
	1 pcs Double Plastic Hammer 30 mm		
	8 pcs Hex Key Set 2-10 mm 2 mm, 2.5 mm, 3 mm, 4 mm 5 mm, 6 mm, 8 mm, 10 mm		
	1 set Impact Driver 11 pcs		
	1 pcs Plastic Handle Screwdriver (-) 3x 100 mm		
	1 pcs Feeler Gauge 13 Blades		
	1 pcs Scrapper		
	3 pcs T-Type Wrench Rubber Handle 8 mm, 10 mm, 12 mm		
	1 pcs Square Drive		
	1 pcs Metal Case		



AUTOMOTIVE

STORAGE

TRAY

AIR TOOLS

HEX KEY

GENERAL TOOLS

Tersedia di :

QHOMEMART



MECHANIC TOOL SET 60 PCS

MEKANIK TOOLS 60 PCS (TB PLASTIK)

ITEM CODE	SIZE
SC-MT0626	60 PCS

SIZE	CONTENT	WEIGHT (gr)	QTY / BOX INNER/MASTER
60 pcs	8 pcs 1/4" DR. Hand Socket 8 mm, 9 mm, 10 mm, 11 mm 1/4", 5/16", 11/32", 3/8"	2,180	1 / 5 set
	9 pcs 3/8" DR. Hand Socket 6 PT 12 mm, 13 mm, 14 mm, 15 mm, 17 mm 7/16", 1/2", 9/16", 5/8", 3/4"		
	7 pcs Combination Wrench 8 mm, 10 mm, 11 mm, 12 mm 14 mm, 17 mm, 19 mm		
	1 pcs 3/8" DR. Ratchet Handle 8" Rubber Handle 72 Teeth		
	1 pcs Ball Pein Hammer 8 OZ		
	1 pcs Long Nose Plier 6"		
	1 pcs Linesman Plier 7"		
	1 pcs Adaptor 3/8" F x 1/4" M		
	2 pcs Go-Thru Screwdriver Green Handle (-) 6 x 100 mm, (-) 6 x 150 mm		
	10 pcs Magnetic Bit Driver		
	1 pcs Bit Driver		
	1 pcs Water Pump Plier 10"		
	1 pcs Cutter Knife 18 mm		
	4 pcs Insulation Precision Screwdriver (+) #00, (+) #0, (-) 1.4, (-) 1.8		
	1 pcs Measuring Tape 3 mm		
	1 pcs Adjustable Wrench 8"		
	1 pcs Clip		
	8 pcs Assortment Box		
	1 pcs Blow Mould Case		



MECHANIC TOOL SET 100 PCS

MEKANIK TOOLS 100 PCS (TB PLASTIK)

ITEM CODE	SIZE
SC-MT0627	100 PCS

SIZE	CONTENT	WEIGHT (gr)	QTY / BOX INNER/MASTER
100 pcs	10 pcs 1/4" DR. Hand Socket 6 PT 10 mm, 11 mm, 12 mm, 13 mm, 14 mm 15 mm, 17 mm, 19 mm, 22 mm, 24 mm	5,550	1 / 2 set
	9 pcs 1/4" DR. Socket 6 PT 5 mm, 6 mm, 7 mm, 8 mm, 9 mm 10 mm, 11 mm, 12 mm, 13 mm		
	7 pcs Combination Wrench 8 mm, 10 mm, 11 mm, 12 mm 13 mm, 14 mm, 17 mm, 19 mm		
	1 pcs 1/2" DR. Ratchet Handle 72 Teeth Rubber Handle 10"		
	1 pcs Ball Pein Hammer 8 OZ		
	1 pcs 1/2" DR. Universal Joint		
	1 pcs Five Way Deluxe Crimping Tool 9"		
	5 pcs Go-Thru Screwdriver Green Handle (+) #2 x 38 mm, (+) 2 x 100 mm (-) 6 x 38 mm, (-) 6 x 100 mm, (-) 8 x 200 mm		
	1 pcs Locking Plier Curved 10"		
	1 pcs Water Pump Plier Type A6 10"		
	4 pcs Hex Key Short 5 mm, 6 mm, 8 mm, 10 mm		
	1 pcs Magnetic Bit Driver		
	42 Pcs Wire Connector (Male & Female)		
	1 pcs Auto Voltage Tester		
	10 pcs Bit Driver		
	1 pcs Additional Socket		
	1 pcs 1/2" DR. Extension Bar 5"		
	1 pcs 1/2" DR. Sliding T Bar 10"		
	1 pcs 1/2" DR. Spark Plug 16 mm		
	1 pcs 1/2" DR. Spark Plug 21 mm		



AUTOMOTIVE

STORAGE

TRAY

AIR TOOLS

HEX KEY

GENERAL TOOLS

MECHANIC TOOL SET 130 PCS

MEKANIK TOOLS 130 PCS (TB PLASTIK)

SIZE	CONTENT	WEIGHT (gr)	QTY / BOX INNER/MASTER
130 pcs	17 pcs 1/4" DR. Hand Socket 4 mm, 4.5 mm, 5 mm, 5.5 mm, 6 mm 7 mm, 8 mm, 9 mm, 10 mm 5/32", 3/16", 7/32", 1/4" 9/32", 5/16", 11/32", 3/8"	5,504	1 / 2 set
	14 pcs 3/8" DR. Hand Socket 11 mm, 12 mm, 13 mm, 14 mm 15 mm, 17 mm, 19 mm 3/8", 7/16", 1/2", 9/16", 5/8", 11/16", 3/4"		
	7 pcs Open End Wrench 6 x 7 mm, 8 x 9 mm, 10 x 11 mm, 12 x 13 mm 14 mm, 15 mm, 16 mm, 17 mm, 18 mm		
	1 pcs 3/8" DR. Ratchet Handle 8" Rubber Handle 72 Teeth		
	1 pcs Ball Pein Hammer with Fiber 08 OZ		
	1 pcs Five Way Deluxe Crimping Tool 9"		
	1 pcs Long Nose Plier 6"		
	10 pcs 1/4" DR. Single Head Bits Hexagon 25 mm H1.5, H2, H2.5, H3, H4, H5, H5.5, H6, H7, H8		
	4 pcs 1/4" DR. Single Head Bits Phillips 25 mm PH0, PH1, PH2, PH3		
	5 pcs 1/4" DR. Single Head Bits Torque 25 mm T8, T10, T15, T20, T30		
	3 pcs 1/4" DR. Slotted Bits Socket 25 mm SL3, SL4, SL6		
	1 pcs PVC Tape		
	8 pcs Hex Key 1.5 mm, 2 mm, 2.5 mm, 3 mm, 4 mm 5 mm, 5.5 mm, 6 mm		
	1 pcs Magnetic Bit Driver		
	1 pcs Wire Brush		
	1 pcs Auto Voltage Tester		
	1 pcs 3/8" Extension Bar 3"		
	2 pcs Blade Fuses Mini Size 20 AMP		
	1 pcs 3/8" DR. Spark Plug 21 mm		
	1 pcs Cutter Knife 18 mm		
	1 pcs Radiator Tester		
	1 pcs Tire Pressure Gauge 160 LB/IN ²		
	2 pcs Blade Fuses Mini Size 10 AMP, 15 AMP		
	20 pcs Terminals		
	16 pcs Nylon Cable Ties		
	1 pcs Adaptor 3/8" F x 1/4" M		
	1 pcs Slip Joint Plier 6"		
	1 pcs Spark Plug Gap Gauge		
	1 pcs Feeler Gauge 0.05 mm - 1 mm		
	4 pcs Precision Screwdriver (+) #00, (+) #0, (-) 1.4, (-) 1.8		
	1 pcs Blow Mold Case		

ITEM CODE	SIZE
SC-MT0628	130 PCS



AUTOMOTIVE

STORAGE

TRAY

AIR TOOLS

HEX KEY

GENERAL TOOLS

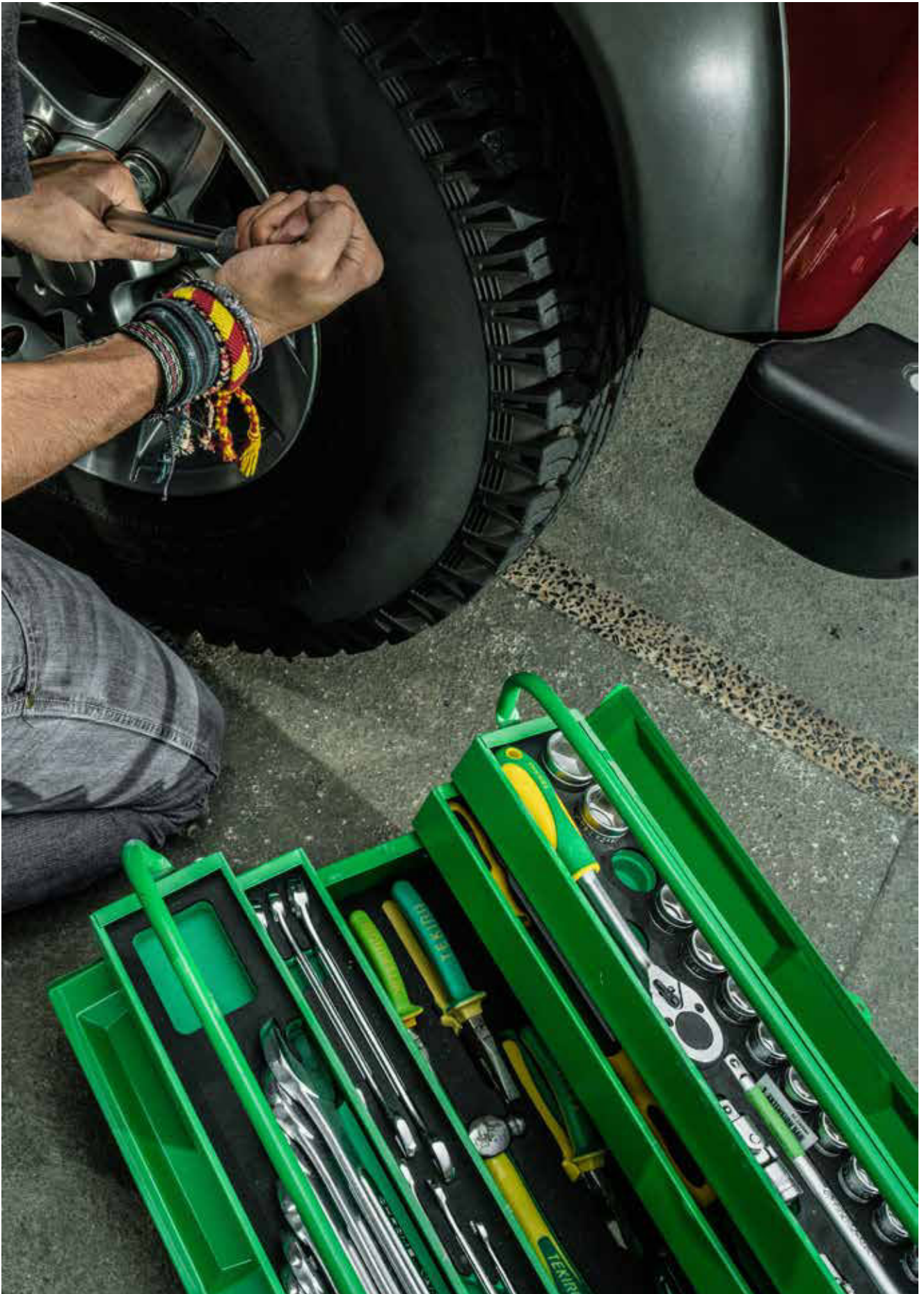

TOOL BOX SET 66 PCS

TOOL BOX SET 66 PCS

ITEM CODE	CONTENT	WEIGHT (gr)	QTY / BOX INNER/MASTER
ST-TB1651	3 pcs TPR Go-Thru Screwdriver (-) 5 x 75 mm, 6x 100 mm, 8 x 200 mm	16,900	1 set
	2 pcs TPR Go- Thru Screwdriver (+) PH1 x 75 mm (5), PH2 x 100 mm (6)		
	14 pcs Combination Wrench (8 mm, 10 mm, 11 mm, 12 mm, 13 mm, 14 mm, 17 mm, 19 mm, 20 mm, 22 mm, 24 mm, 27 mm, 30 mm, 32 mm)		
	7 pcs Punch & Chisel Set 7 pcs		
	18 pcs Socket 1/2" DR 6 PT (10 mm, 11 mm , 12 mm, 13 mm, 14 mm, 15 mm, 16 mm, 17 mm, 18 mm, 19 mm, 20 mm, 21 mm, 22 mm, 23 mm, 24 mm, 27 mm, 30 mm, 32 mm)		
	1 pcs DR. Ratchet Handle 10" Green Yellow (SM)		
	2 pcs Extention Bar 5",10"		
	1 pcs Universal Joint 1/2"		
	1 pcs Flexible Handle 1/2" x 15"		
	1 pcs Ball Pein Hammer 8 Oz		
	1 pcs Double Plastic Hammer 35 mm		
	9 pcs Ball Point Hex Key Set Long 9 pcs		
	1 pcs Waterpump Pliers 10"		
	1 pcs Linesman Pliers 7"		
	1 pcs Long Nose Pliers 6"		
	1 pcs Diagonal Pliers 6"		
	1 pcs Tool Box 3 Susun (550x200x290 mm)		
	1 pcs EVA Tool Box Set		



AUTOMOTIVE

STORAGE

TRAY

AIR TOOLS

HEX KEY

GENERAL TOOLS



UNIVERSAL RADIATOR PRESSURE TEST KIT 18 PCS

UNIVERSAL RADIATOR PRESSURE TEST KIT 18 PCS

ITEM CODE	CONTENT		WEIGHT (gr)	QTY / BOX INNER/MASTER
AU-UR1725	10 pcs	Nylon Test Caps	1,100	1 / 4 set
	3 pcs	Steel Test Caps		
	2 pcs	Radiator Cap Test Tubes		
	1 pcs	Pressure Testing Pump with Gauge		
	1 pcs	Thermometer		
	1 pcs	Handle		

- Check leakages of original radiator cap and cooling system
- Durable blow mould case
- Pressure testing pump with gauge.
- Pressure range: 0-35psi , 0-2.5bar with pressure relief valve and quick coupler



BATTERY TESTER

ALAT TES AKI

ITEM CODE	SIZE	WEIGHT (gr)	QTY / BOX INNER/MASTER
AU-BT1991	7 - 30 VDC	852	1 / 10 pcs

- Test automotive and household electrical problems safely and accurately
- Four main functions: battery test, cranking test, max-load test, charging test
- Data hold and large digital display with 3.2" HD Color Screen for visibility in dimly light areas
- Multi language options: English, Russian, German, Chinese, Thai, Japanese, etc
- One click data printing
- This meter can not test AC current; ensure your Multimeter is set to the correct setting before testing
- Wide measure standard : CCA, DIN, IEC, EN, SAE, JIS



LABOR SAVING WRENCH 1 : 68

KUNCI TORSI RODA TRUK 1 : 68

ITEM CODE	SIZE	WEIGHT (gr)	QTY / BOX INNER/MASTER
AU-LS1794	1:68	770	1 / 3 set

- Perfect tool for trucks, RVs or any other heavy duty vehicles
- Extended torque for hard to turn bolts
- Comes in durable plastic case for easy storage
- Material: High-quality Alloy steel

HYDRAULIC PRESS 15 TON

MESIN PRESS 15 TON

ITEM CODE	SIZE	1 (mm)	2 MAX (mm)	2 MIN (mm)	3 (mm)	4 (mm)	5 (mm)	6 (mm)	7 (mm)	8 (mm)	WEIGHT (gr)	QTY / BOX INNER/MASTER
AU-HP1559	15 Ton	1,633	880	200	865	560	170	630	290	90	176,000	1 set

USERS:

1. Auto repair, general machinery, maintenance industry.

APPLICATION:

1. Applied dis-assembly for bearing, gear shaft, bush and industrial machine parts.
2. Suitable for straightening, rectifying & molding for shaft, machine parts, and industrial metal pieces.

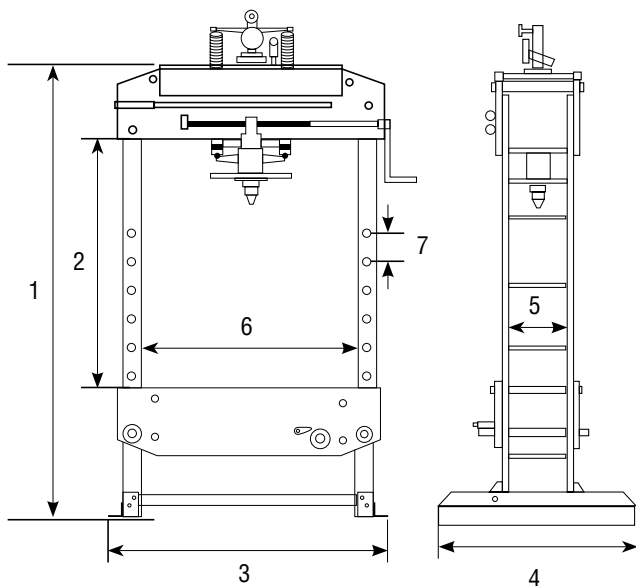

SPECIFICATION

Capacity	: 15 Ton
Cylinder bore	: \varnothing 80mm
Course	: 130mm
Bio-course	: 100mm
Pressure	: 300Kg/cm ²
Cylinder pressure speed	: 2.0mm/R
Reverse pressure speed	: 12mm/sec
Right/left side pitch	: 430mm
CUFT	: 24

ADVANTAGE:

1. Wide range of hydraulic cylinder capacity for more workpieces selection, high quality and durable.
2. Small size frame, operation handle in center-right side location, convenient & safe.
3. Independent hydraulic system is easy to maintain and improves durability.



AUTOMOTIVE

STORAGE

TRAY

AIR TOOLS

HEX KEY

GENERAL TOOLS

HYDRAULIC PRESS 20 TON

MESIN PRESS 20 TON



ITEM CODE	SIZE	1 (mm)	2 (mm)	WEIGHT (gr)	QTY / BOX INNER/MASTER
AU-HP1717	20 Ton	1,495	630	93,000	1 set

- High durable hardness
- Quick for press
- More accurate value

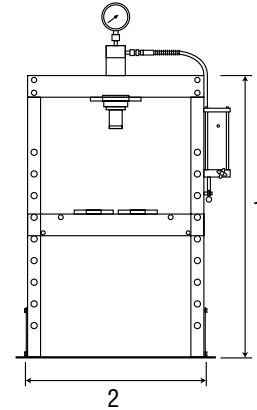

ENGINE CRANE 2 TON

ALAT PENGANGKAT MESIN 2 TON



ITEM CODE	SIZE	1 (mm)	2 (mm)	3 (mm)	4 (mm)	5 (mm)	WEIGHT (gr)	QTY / BOX INNER/MASTER
AU-EC1588	2 Ton	1,620	Max. Height : 1,070 Min. Height : 590	Max. Length : 1,460 Min. Length : 940	1,275	750	85,600	1 / 1 pcs

- Outrigger leg easily folded for transport or storage
- Universal wheel provide
- 4 position weight
- High lifting range

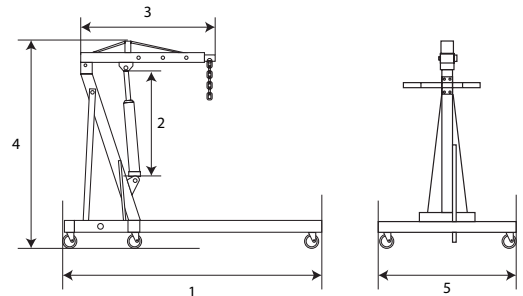

TRANSMISSION JACK

DONGKRAK MESIN



ITEM CODE	SIZE	1 (mm)	WEIGHT (gr)	QTY / BOX INNER/MASTER
AU-TJ1812	500 KG	Min: 1135, max: 1950	38,000	1 / 1 pcs

- Made of high strength steel for maximum durability, and you can use it for a long time with stable performance.
- Comes with foot-operated pump and lowering pedal, great for high position installation and removal of automobile gearbox, car engines.
- Maximum load is 500 Kg

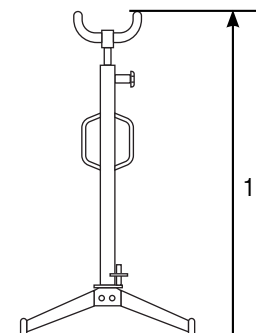

AIR CHUCK TRUCK

ALAT PENGISI ANGIN 12"

ITEM CODE	SIZE	1 (mm)	2 (mm)	3 (mm)	4 (mm)	5 (mm)	WEIGHT (gr)	QTY / BOX INNER/MASTER
AU-AC0993	12"	350	9	15	85	15	160	25 / 100 pcs

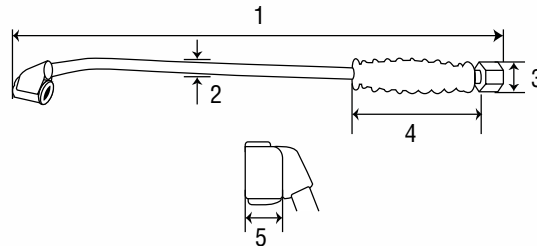

- Material Chrome Vanadium
- Dual head
- Air inflow enlarge
- Suitable for truck tire inflation



TYRE PRESSURE GAUGE 170 PSI

ALAT UKUR TEKANAN ANGIN BAN 170 PSI

ITEM CODE	SIZE	1 (mm)	2 (mm)	3 (mm)	4 (mm)	5 (mm)	6 (mm)	WEIGHT (gr)	QTY / BOX INNER/MASTER
AU-TP1558	170 Psi	160	106	96	13	13	670	863	4 / 16 pcs

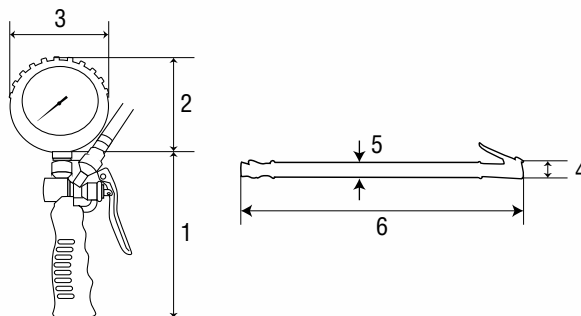

- Ergonomic Handle
- Flexible & High pressure hose



WASTE OIL DRAINER 16 LITER

ALAT SEDOT OLI MESIN

ITEM CODE	SIZE	1 (mm)	2 (mm)	3 (mm)	4 (mm)	5 (mm)	6 (mm)	WEIGHT (gr)	QTY / BOX INNER/MASTER
AU-WO1872	16 L	161.5	41	71.5	58.5	37	32	24,300	1 set

- Operational by using the air compressor
- Simple use without open the oil bolt which can cause damage the oil bolt
- The product made by high quality material
- Suit for : Motorcycles, Cars

SPECIFICATION

Air Inlet Pressure	: 10bar
Air Inlet / Oil Outlet Connection	: -
Ejection Pressure	: 0.6 - 8bar / 8.7-11.6psi
Air Consumption	: 150L / Min
Vacuum Degree	: 0 - 1bar / 0-14.5psi
Tank Capacity	: 70L
Cylinder Capacity	: Cylinder Capacity
Oil Tray Volume	: 16L

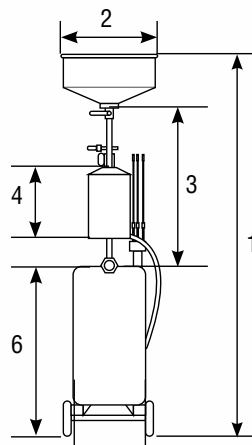

Tersedia di :



AUTOMOTIVE

STORAGE

TRAY

AIR TOOLS

HEX KEY

GENERAL TOOLS

- Thick stainless steel material
- Powerfull magnet
- Anti scratch finish

MAGNETIC TRAY

WADAH MAGNET

ITEM CODE	SIZE	1 (mm)	2 (mm)	WEIGHT (gr)	QTY / BOX INNER/MASTER
GT-MP1612	6"	137	83	308.0	1 / 36 pcs

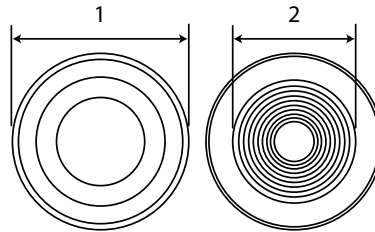

- Heat treated alloy steel
- Comfort anti slip grip
- Sharp and precise edge

SCRAPER

PAHAT

ITEM CODE	SIZE	1 (mm)	2 (mm)	3 (mm)	WEIGHT (gr)	QTY / BOX INNER/MASTER
GT-SC1276	10 X 3 cm	128	63	30	57	10 / 40 pcs

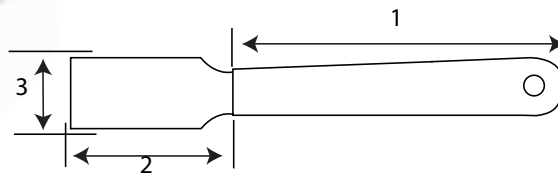

TEKIRO offers a wide range of Automatic Nitrogen Generators for tyre inflation to cater for different vehicles and needs. Nitrogen as an inflation medium can provide the vehicle or fleet owner with significant cost saving benefits. Studies by industry experts have shown that by reducing the oxygen content in the tyres to a very low level, you could keep your tyres correctly inflated for longer which could increase fuel economy and extend the life of an average tyre about 20%.

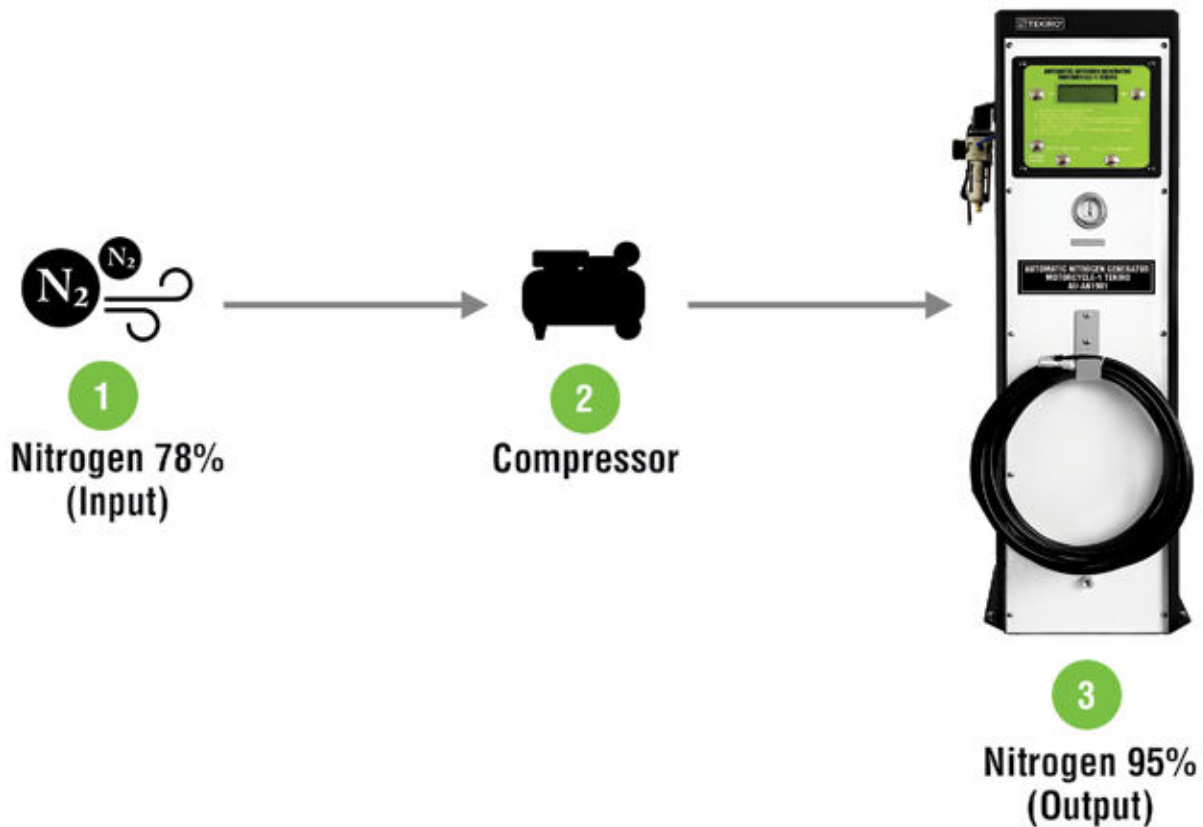

THE ADVANTAGE OF INFLATING THE TIRE WITH NITROGEN

- | | | | | | |
|---|-------------------|---|----------------------------------|---|---|
|  | Improves Steering |  | Reduce Tire Oxidation |  | Decreases False Alarms from Tire Pressure Monitoring System |
|  | Improves Handling |  | Eliminate Inside Wheel Corrosion | | |
|  | Improves Braking |  | Reduce Running Temperatures | | |

AUTOMATIC NITROGEN GENERATOR-1

MESIN PENGISIAN ANGIN NITROGEN MOBIL-1

ITEM CODE	SIZE	1 (mm)	2 (mm)	3 (mm)	WEIGHT (kg)	QTY / FRAME
AU-AN1900	50L	1255	700	435	145	1 unit

- Rugged and durable diecast aluminium enclosure
- Fully automated, fully programmable, micro-processor controlled conversion system
- Suitable for: Motorcycles & Cars

SPECIFICATION

Power Supply : AC110V/220V 50Hz - 60Hz

Power Consumption : 40 Watt

Nitrogen Purity : 95-99%

Input Air Pressure : 87-123psi / 6-8.5bar

Nitrogen Production Speed : 42L/min (1.5cfm)

Nitrogen Output Pressure : 8Bar

Nitrogen Storage Tank : 50L

Packing Size : 1380(H)×730(L)×510(W) mm

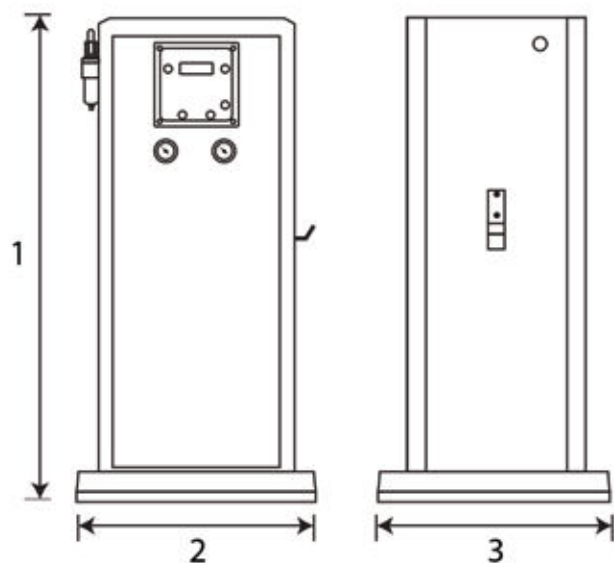

AUTOMATIC NITROGEN GENERATOR MOTORCYCLE-1

MESIN PENGISIAN ANGIN NITROGEN MOTOR-1

ITEM CODE	SIZE	1 (mm)	2 (mm)	3 (mm)	WEIGHT (kg)	QTY / FRAME
AU-AN1901	7L	1160	450	360	92	1 unit

- Small and portable
- Converts 2 tyres to nitrogen simultaneously with a touch of a button
- Fast and up to 30% time savings
- Suitable for: Motorcycles

SPECIFICATION

Power Supply	: AC110V/220V 50Hz - 60Hz
Power Consumption	: 27 Watt
Nitrogen Purity	: 95-99%
Input Air Pressure	: 87-123psi / 6-8.5bar
Nitrogen Production Speed	: 35L/min (1.3cfm)
Nitrogen Output Pressure	: ≤90psi / 6.2bar
Nitrogen Storage Tank	: 7L
Packing Size	: 1240(H) × 450(L) × 390(W) mm

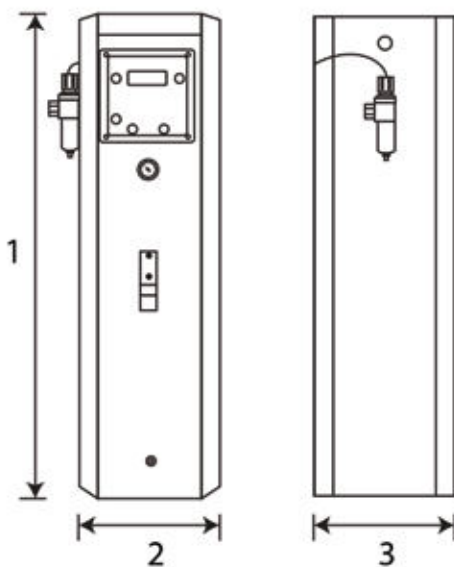

AUTOMATIC NITROGEN GENERATOR

MESIN PENGISIAN ANGIN NITROGEN

ITEM CODE	SIZE	1 (mm)	2 (mm)	3 (mm)	WEIGHT (kg)	QTY / FRAME
AU-AN1813	70 L	1420	700	510	128	1 unit

- Presetting pressure automatically vacuum, fill N2 & test pressure to the desired value
- High Purity
Equipment adopts high-octane BF-200#
- Carbon Molecular sieve
- High Precision pressure sensor is made by Novasensor, USA
- One button / touch for easy operation
Suitable for Motorcycles, Cars, Vans, Mini-Buses and Light Trucks



SPECIFICATION

Power Supply	: AC110V/220V 50Hz - 60Hz
Power Consumption	: 60 W
Nitrogen Purity	: 95-99.5%
Input Air Pressure	: ≤174psi / 12bar
Nitrogen Production Speed	: 66L/min (2.3cfm) at 145psi / 10bar
Nitrogen Output Pressure	: ≤98psi / 6.8bar
Nitrogen Storage Tank	: 70L
Packing Size	: 1560(H) ×760(L) ×620(W) mm

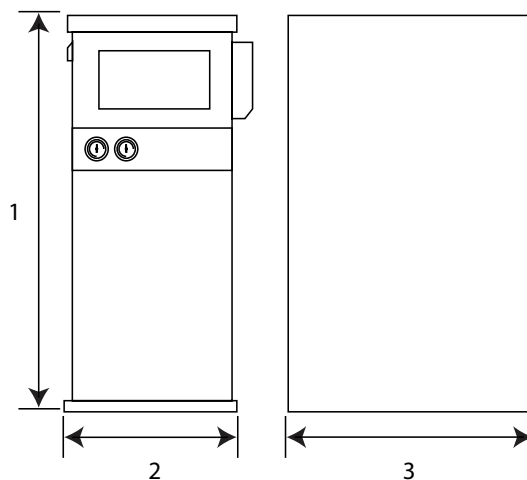

TIRE CHANGER -1

MESIN PENGGANTI BAN -1

- Large cylinder for power arm
- Strong tire-pressing
- Smooth rotary pressing tire
- Shoveling tire smoothly

ITEM CODE	SPECIFICATION	QTY / BOX INNER/MASTER
AU-TC1876	Semi Automatic Swing Arm	1 unit
	Suitable for Motorcycle and Car Tire Changing	
	Motor Power: 0.75 KW	
	Max. Wheel Diameter: 41" (1.040 mm)	
	Max. Wheel Width: 14" (355 mm)	
	Clamping: 6" - 24"	
	Air Supply: 8 Bar	
Bread Breaker Force: 2.500 Kgs		

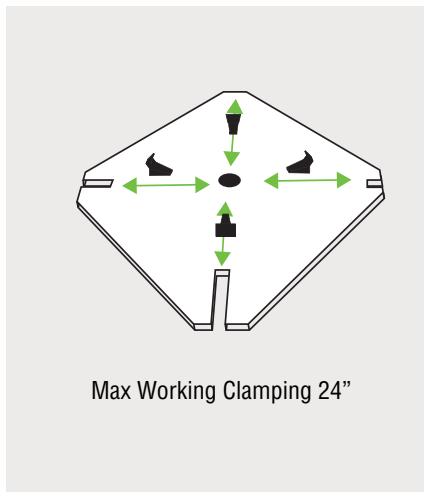
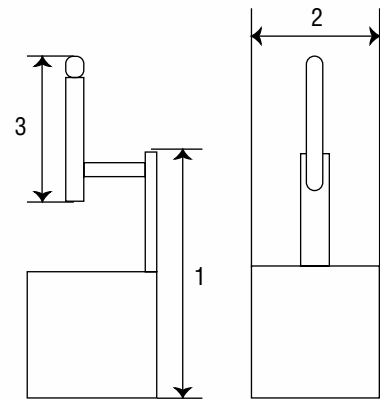

Clamping jaws are totally one step die casting

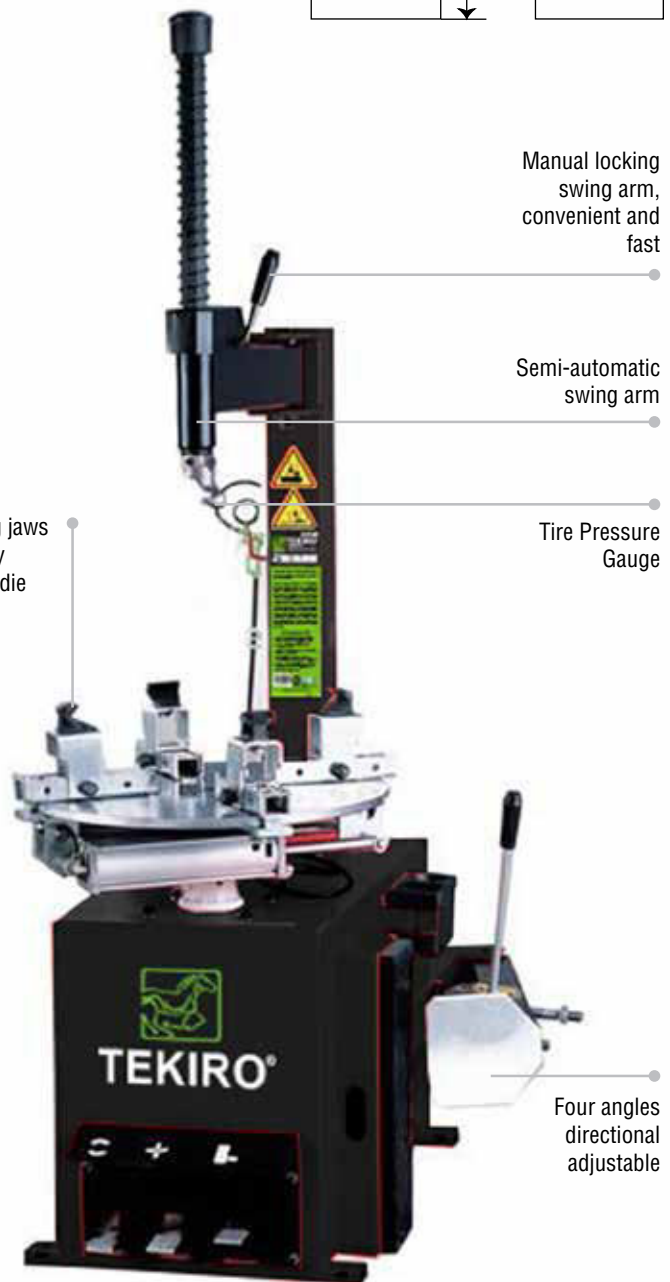

AUTOMOTIVE

STORAGE

TRAY

AIR TOOLS

HEX KEY

GENERAL TOOLS

WHEEL BALANCER

WHEEL BALANCER (DIGITAL DISPLAY)

ITEM CODE	SIZE	1 (mm)	2 (mm)	3 (mm)	WEIGHT (kg)	QTY / BOX INNER/MASTER
AU-WB1925	10"-24"	1,250	1,100	1,700	115	1 unit

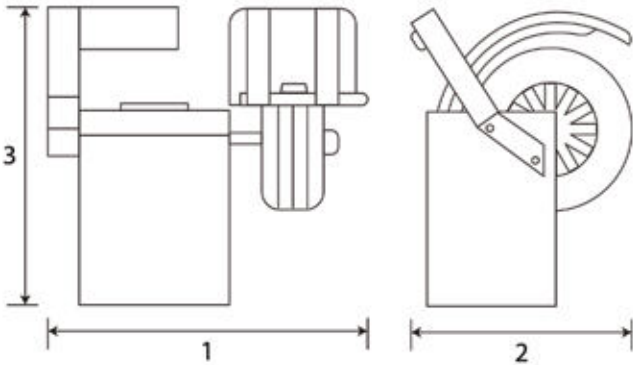

SPECIFICATION

Balancing Accuracy	: 1gr
Balancing Speed	: 200rpm
Cycle Time	: 10s
Rim Diameter	: 10"-24"
Rim Width	: 1.5"-20"
Max. Wheel Weight	: 65kg

TEKIRO wheel balancer is capable of balancing wheels up to 24" in diameter and weigh up to 65kg. This machine is complete with the 6 balancing mode.

- Latest advanced technology - High precision of self adhesive weight position finding
- High precision main shaft ensures repeated measuring accuracy
- Tracking sticking balancing mode can locate weights precisely and rapidly
- With self-calibration and self-diagnostics functions
- LED light and digital display
- Bigger machine body



WHEEL BALANCER

WHEEL BALANCER

ITEM CODE	SIZE	1 (mm)	2 (mm)	3 (mm)	WEIGHT (kg)	QTY / BOX INNER/MASTER
AU-WB1926	10"-24"	960	760	1,160	105	1 unit

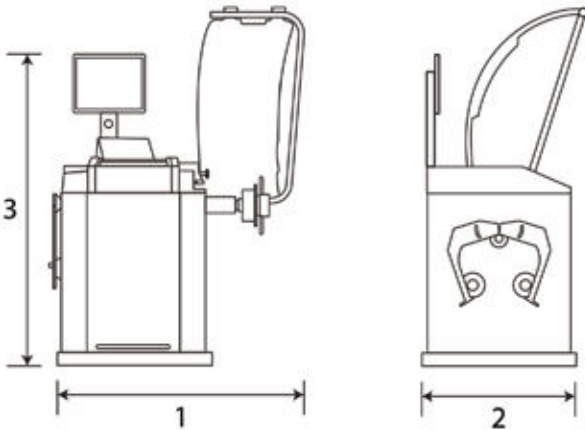

SPECIFICATION

Balancing Accuracy	: 1gr
Balancing Speed	: 200rpm
Cycle Time	: 8s
Rim Diameter	: 10"-24"
Rim Width	: 1.5"-20"
Max. Wheel Weight	: 65kg

TEKIRO Fully automatic wheel balancer uses automatic data entry for all 4 wheel parameters making it very simple to use. The 15" colour LED monitor produces high-quality images and feeds back user information during every step of the balancing procedure. This makes the machine one of the easiest, error free balancing machine on the market.

- Latest advanced technology - High precision of self adhesive weight position finding
- Laser Configuration
- High precision main shaft ensures repeated measuring accuracy
- Automatic distance and wheel diameter measuring
- Tracking sticking balancing mode can locate weights precisely and rapidly
- With self-calibration and self-diagnostics functions
- 15" LCD monitor, 3D animation interface
- Bigger machine body with deluxe design



MOTORCYCLE BIKE LIFT 360 KG

BIKE LIFT 360 KG

ITEM CODE	SIZE	1 (mm)	2 (mm)	3 (mm)	WEIGHT (kg)	QTY / BOX INNER/MASTER
AU-BL1927	360 kg	780	2,170	490	124	1 unit

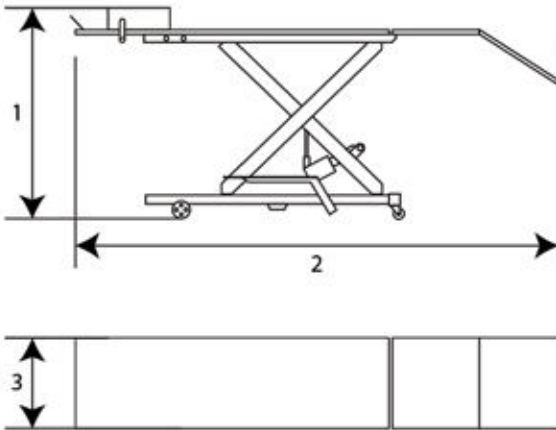

SPECIFICATION

Lifting Capacity	: 360kg
Min. Height	: 210mm
Max. Height	: 780mm
Table Size	: 2,170x490mm



DUAL POWERED MECHANISM (HYDRAULIC AND AIR)

SCISSORS LIFT 3 TON

MOBILE MINI SCISSORS LIFT 3 TON

ITEM CODE	SIZE	1 (mm)	2 (mm)	3 (mm)	4 (mm)	5 (mm)	6 (mm)	WEIGHT (kg)	QTY / BOX INNER/MASTER
AU-SL1924	3 Ton	1943	1000	1420	1954	460	860	480	1 unit

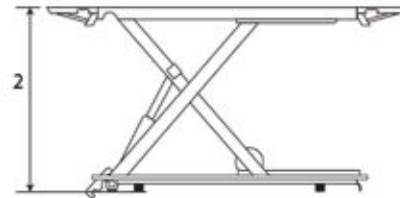
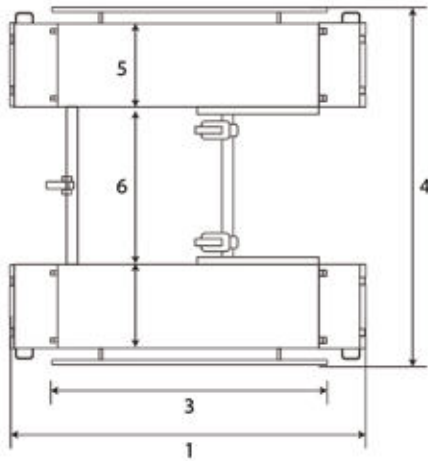

SPECIFICATION

Lifting Capacity	: 3,000kg
Min. Height	: 110mm
Max. Height	: 1,000mm
Table Size	: 1,420x460mm
Motor Power	: 2.2kw

When you need to save space but desire a full standing room under a raised vehicle, **TEKIRO** scissor lift is an ideal choice. **TEKIRO** Scissors Lift designs are open-centre, so mechanics can perform all undercarriage services, unobstructed by cross members. A suite of optional accessories provides full wheel service capability on low-stance cars.

- Ready to use directly out of the box.
- Low profile extendable platform design, for a wide range of services.
- Pneumatic locking system.
- Space-saving design helps turn wasted floor space into a valuable service area.
- Lift raises in just under one minute.
- Automatic safety locks secure lift at multiple service heights. The control panel features simple push-button up and down controls and pneumatic safety release.



2-POST CAR LIFT 4 TON

TWO-POST LIFT 4 TON

ITEM CODE	SIZE	1 (mm)	2 (mm)	3 (mm)	4 (mm)	5 (mm)	WEIGHT (kg)	QTY / BOX INNER/MASTER
AU-CL1923	4 Ton	3,433	770-1,105	104	1,913	3,762	695	1 unit

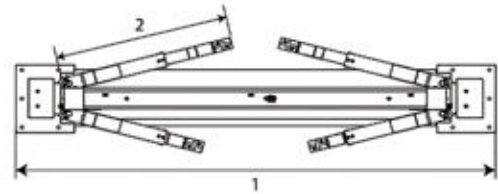
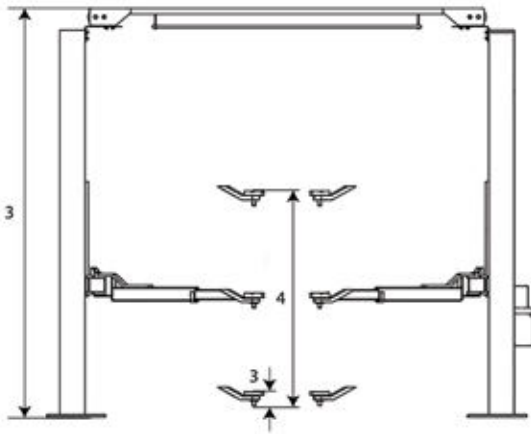

SPECIFICATION

Lifting Capacity	: 4,000kg
Max. Height	: 1,913mm
Motor Power	: 2.2kw

The **TEKIRO 2-POST CAR LIFT 4 TON** offers the convenience of wide or narrow installation wrapped up into one configurable package. The durable, safe and reliable car lift features an expandable top beam and Tru-Metric arms to suit virtually every vehicle lifting requirement. It's a simple yet highly sophisticated lift designed to minimize service and maintenance costs while delivering low operating expenses and high productivity.

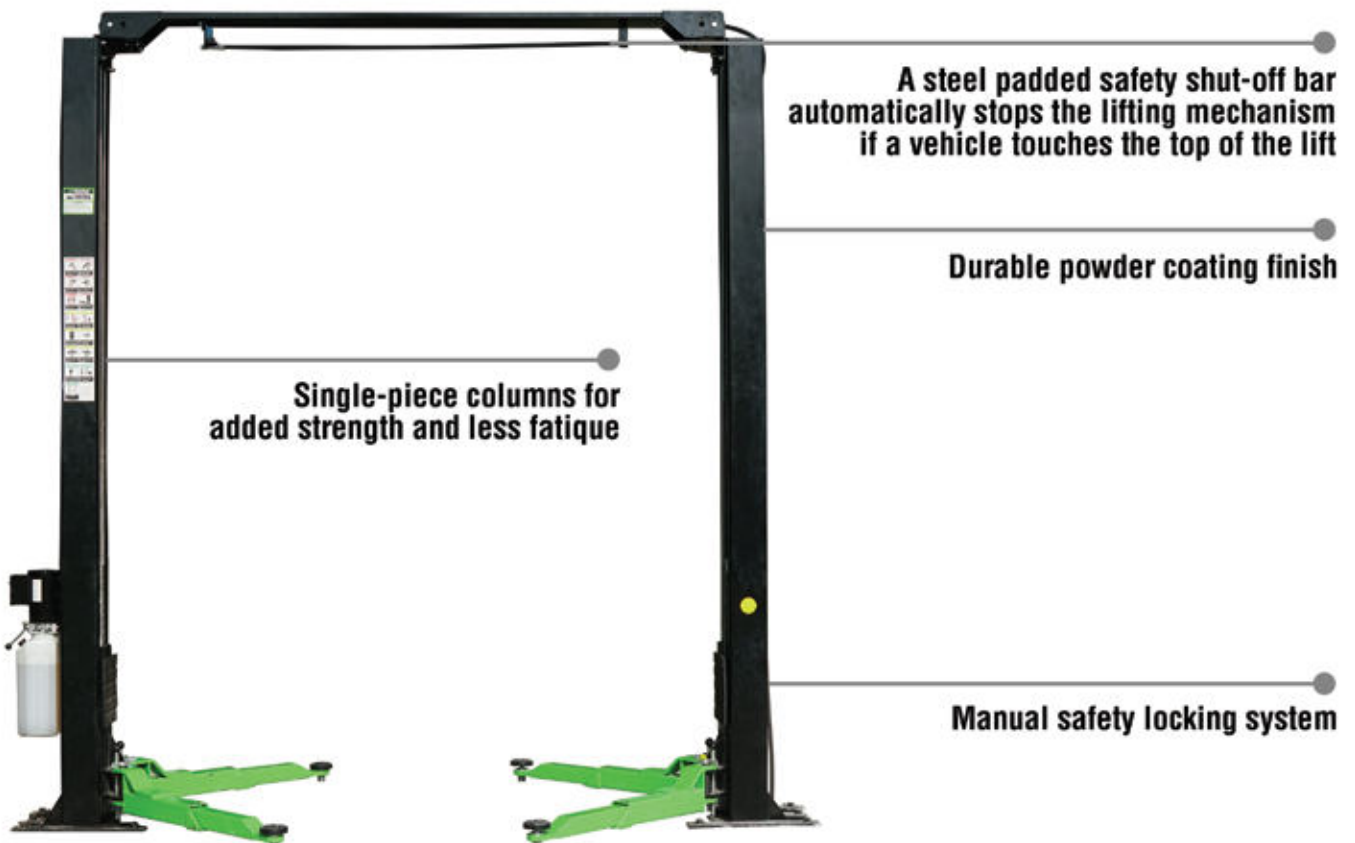



CABINET 6 DRAWER

TEKIRO Drawer Cabinets can be described in simple words. Tough, durable and rugged construction.

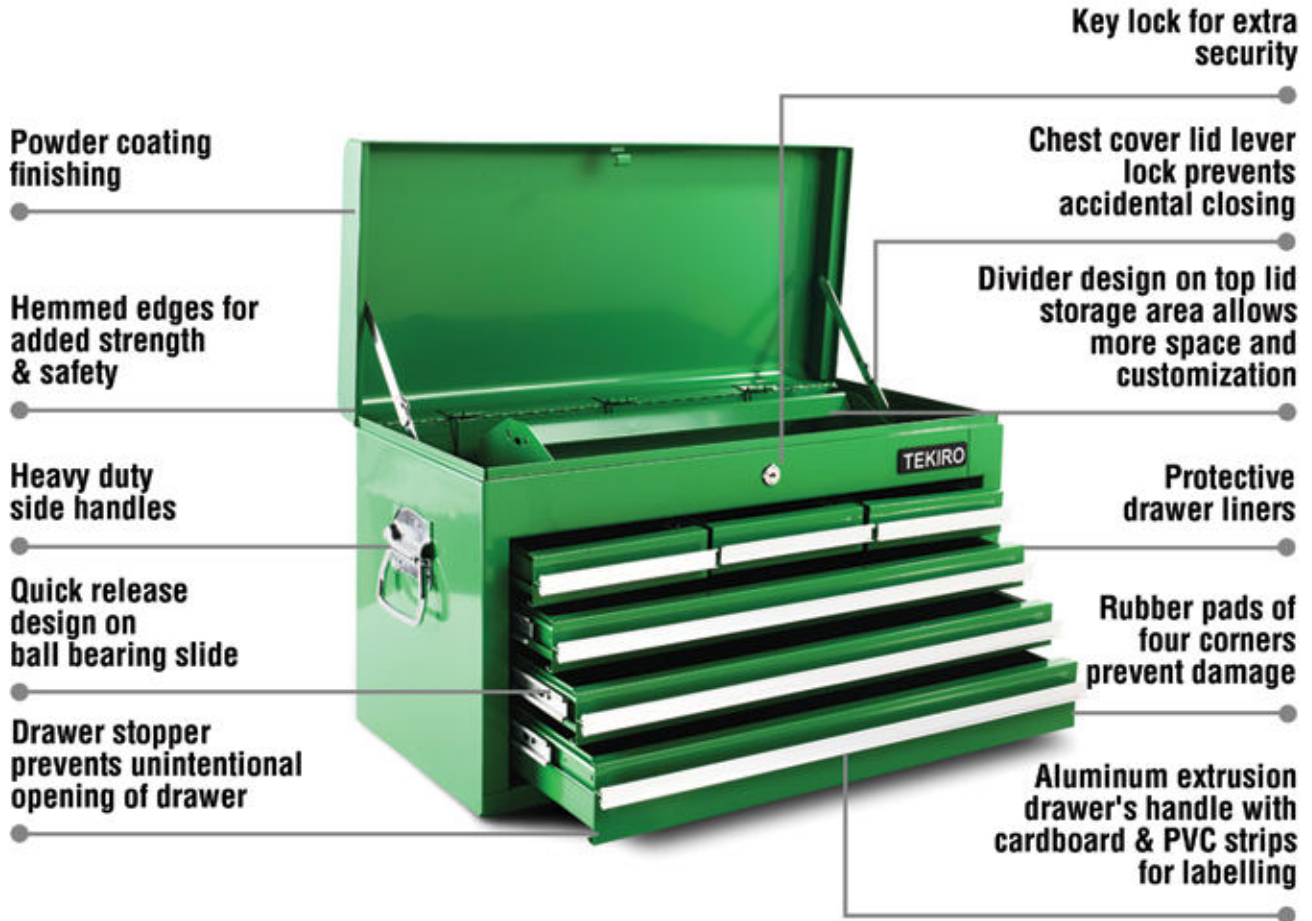

STEEL THICKNESS:

Body : 0.8 mm | Drawer : 0.7 mm | Drop-front : 1.0 mm



Three top drawers



Interchangeable Drawer

CABINET 3 DRAWER

KABINET MEKANIK 3 LACI TB14003-X

- All steel for strength and durability
- Full bearing drawer slides for smooth operation
- High load capacity

ITEM CODE	SIZE	1 (mm)	2 (mm)	3 (mm)	4 (mm)	5 (mm)	6 (mm)	7 (mm)	WEIGHT (gr)	QTY / BOX INNER/MASTER
ST-CA1062	TBI 4003X	669	503	315	266	46	75	100	14,700	1 pcs

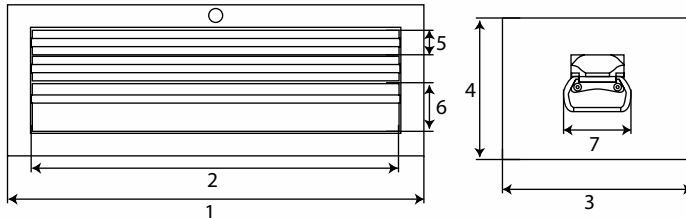

CABINET 4-1 DRAWER

KABINET MEKANIK 4 LACI -1

- All steel for strength and durability
- Full bearing drawer slides for smooth operation
- High load capacity

ITEM CODE	SIZE	1 (mm)	2 (mm)	3 (mm)	4 (mm)	5 (mm)	6 (mm)	7 (mm)	WEIGHT (gr)	QTY / BOX INNER/MASTER
SR-CA1834	61 X 31 X 38 CM	660	593	307	377	74.5	48	193.5	21,500	1 pcs

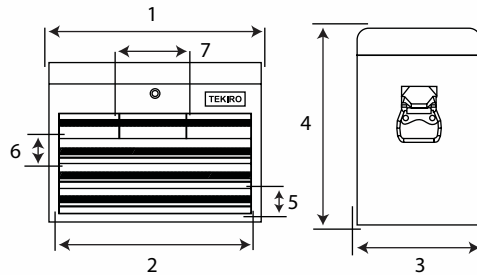

CABINET 6 DRAWER

KABINET MEKANIK 6 LACI TBT4006E

- All steel for strength and durability
- Full bearing drawer slides for smooth operation
- High load capacity

ITEM CODE	SIZE	1 (mm)	2 (mm)	3 (mm)	4 (mm)	5 (mm)	6 (mm)	7 (mm)	WEIGHT (gr)	QTY / BOX INNER/MASTER
ST-CA1063	TBT 4006E	660	593	307	377	75	48	195	21,500	1 pcs

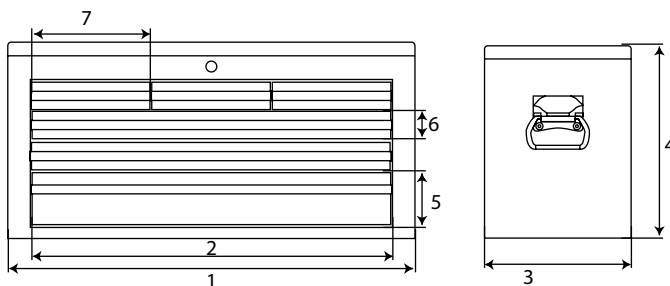

AUTOMOTIVE

STORAGE

TRAY

AIR TOOLS

HEX KEY

GENERAL TOOLS

- High durability steel construction
- Full bearing drawer slides for smooth operation
- High load capacity
- Roller Castors included as spare parts

CABINET 4 DRAWER

TROLI KABINET MEKANIK 4 LACI (TBR 3003)

ITEM CODE	SIZE	1 (mm)	2 (mm)	3 (mm)	4 (mm)	5 (mm)	6 (mm)	7 (mm)	WEIGHT (gr)	QTY / BOX INNER/MASTER
ST-RC1064	TBI 3003	849	688	457	264	153	100	612	38,000	1 pcs

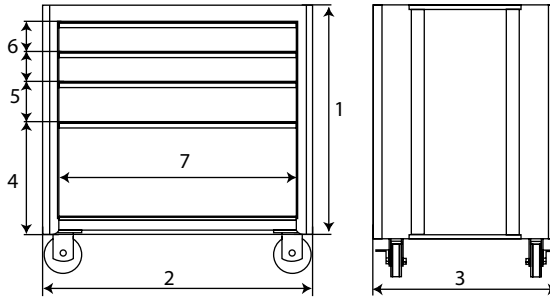

- High durability steel construction
- Full bearing drawer slides for smooth operation
- High load capacity
- Roller Castors included as spare parts

CABINET 7 DRAWER

TROLI KABINET MEKANIK 7 LACI (TBR 3007)

ITEM CODE	SIZE	1 (mm)	2 (mm)	3 (mm)	4 (mm)	5 (mm)	6 (mm)	7 (mm)	WEIGHT (gr)	QTY / BOX INNER/MASTER
ST-RC1065	TBI 3007	850	672	450	210	110	50	610	47,000	1 pcs

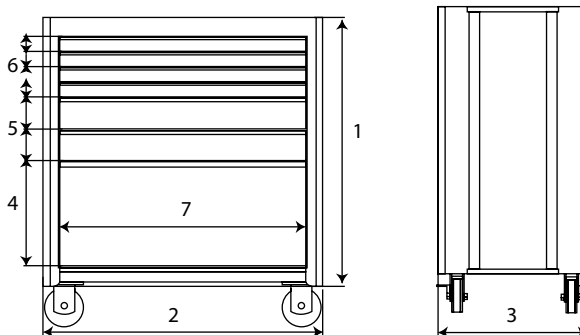

TOOL BOX TB1072

Made of thick-walled Polypropylene material for excellent shock resistance. This toolbox is built to withstand the toughest condition. The removable top lid organizers allow for small part storage while the larger area below the tray provides room for heavier and larger tools.

ABS handle
& buckle



Shock
resistance

Polypropylene
material



Portable tools storage
with plenty of capacity & Keep
your tools organized



Tray separator to
organize heavy and
light tools

AUTOMOTIVE

STORAGE

TRAY

AIR TOOLS

HEX KEY

GENERAL TOOLS

- Material : Polypropylene with ABS handle & buckle
- Shock resistance
- Loading capacity 30 kg



TOOL BOX TB1069

KOTAK PERKAKAS TB 901 (0201)

ITEM CODE	SIZE	1 (mm)	2 (mm)	3 (mm)	WEIGHT (gr)	QTY / BOX INNER/MASTER
ST-TB1069	TB901	380	139	169	890	1 / 10 pcs

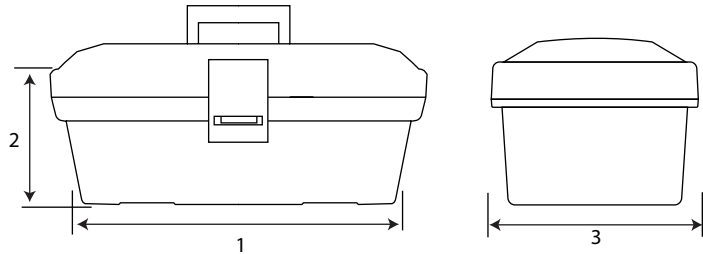

- Material : Polypropylene with ABS handle & buckle
- Shock resistance
- Loading capacity 30 kg



TOOL BOX TB1070

KOTAK PERKAKAS TB 902 (0210)

ITEM CODE	SIZE	1 (mm)	2 (mm)	3 (mm)	WEIGHT (gr)	QTY / BOX INNER/MASTER
ST-TB1070	TB902	440	200	226	1,680	1 / 6 pcs

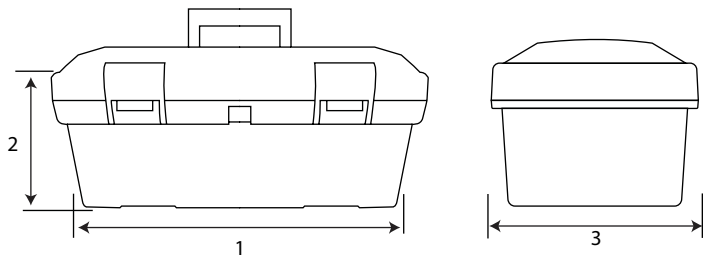

- Material : Polypropylene with ABS handle & buckle
- Shock resistance
- Loading capacity 30 kg



TOOL BOX TB1071

KOTAK PERKAKAS TB 905 (0205)

ITEM CODE	SIZE	1 (mm)	2 (mm)	3 (mm)	WEIGHT (gr)	QTY / BOX INNER/MASTER
ST-TB1071	TB905	410	204	226	1,980	1 / 6 pcs

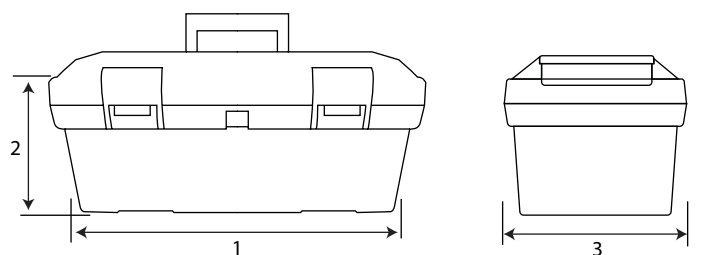

TOOL BOX TB1072

KOTAK PERKAKAS TB 800 (02800)

ITEM CODE	SIZE	1 (mm)	2 (mm)	3 (mm)	WEIGHT (gr)	QTY / BOX INNER/MASTER
ST-TB1072	TB800	481	268	238	2,360	1 / 4 pcs

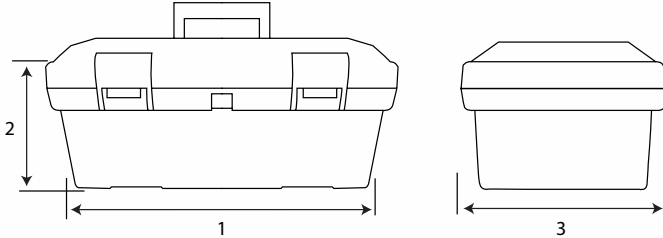

- Polypropylene with ABS handle & buckle
- Shock resistance
- Loading capacity 30 kg



TOOL BOX (METAL CASE)

KOTAK PERKAKAS

ITEM CODE	SIZE	1 (mm)	2 (mm)	3 (mm)	WEIGHT (gr)	QTY / BOX INNER/MASTER
ST-TB1067	T-325	355	115	145	1,060	1 / 12 pcs
ST-TB1066	T-528	410	125	150	1,310	1 / 12 pcs

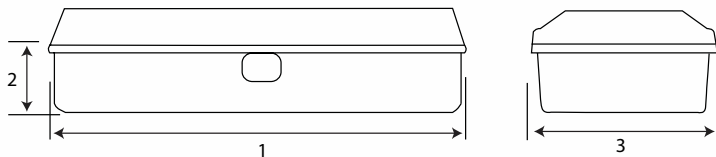

- Lock hook for safety
- Strong hinge



TOOL BOX

KOTAK PERKAKAS 3 SUSUN

ITEM CODE	SIZE	1 (mm)	2 (mm)	3 (mm)	4 (mm)	5 (mm)	6 (mm)	7 (mm)	WEIGHT (gr)	QTY / BOX INNER/MASTER
ST-TB1068	550 x 200 290 mm	555	119	50	200	231	300	500	4,760	1 pcs

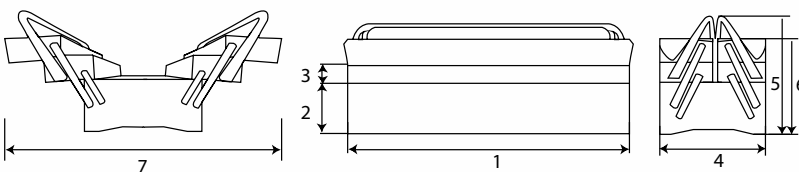

- Lock hook for safety
- Strong hinge



TOOL BAG

TAS PERKAKAS

ITEM CODE	SIZE	1 (mm)	2 (mm)	3 (mm)	WEIGHT (gr)	QTY / BOX INNER/MASTER
ST-BA1073	39 X 8 X 11 cm	390	150	70	111	1 / 250 pcs

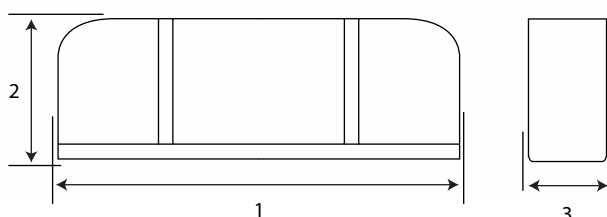

- Easy tool access
- Durable tool bag
- Comfortable to carry



CABINET 7 DRAWER

This is the most comprehensive and favourite among the mechanics. It has ample drawers and space to store a complete set of tools while providing a high impact working surface that could absorb heavy hammer blows and vibration.



High Impact working surface absorbs vibration (20mm thickness)

Side handle for easy handling

One piece steel body structure for extreme strength

Powder coating finishing

2 swivel castors with lock

Key lock for extra security

Hemmed edge for all drawers and body to add strength and safety

Quick release design on ball bearing slide

Pushing unlocked drawer to be locked while all others are locked

Protective drawer liners

2 Fixed castors



Quick release design on ball bearing slide



Drawer interchangeable



Tool tray on the side can be holder for frequently used supplies



Castors made of TPR material reduces noise during movement. Swivel castors with locking mechanism

**CAPACITY
EACH DRAWER :
50 kgs**

STEEL THICKNESS:

Top & Bottom covers : 1.2 mm
Body : 1.0 mm
Drawer : 1.0 mm

CABINET 3 DRAWER

TROLI KABINET MEKANIK 3 LACI

ITEM CODE	SIZE	1 (mm)	2 (mm)	3 (mm)	4 (mm)	5 (mm)	WEIGHT (gr)	QTY / BOX INNER/MASTER
ST-RC1590		650	710	490	470	230	52,000	1 set

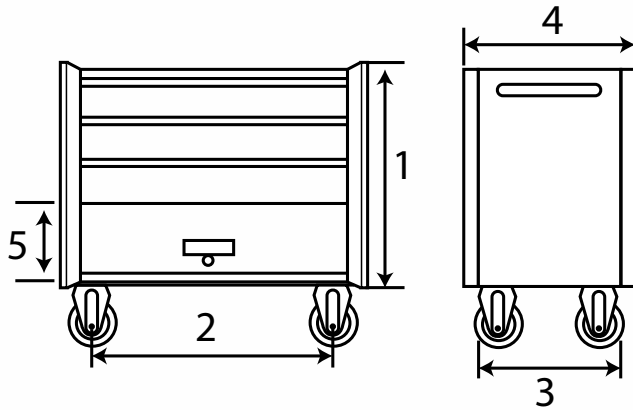

AUTOMOTIVE

STORAGE

TRAY

CABINET 5 DRAWER

TROLI KABINET MEKANIK 5 LACI

ITEM CODE	SIZE	1 (mm)	2 (mm)	3 (mm)	4 (mm)	5 (mm)	WEIGHT (gr)	QTY / BOX INNER/MASTER
ST-RC1589		800	710	500	460	150	70,000	1 set

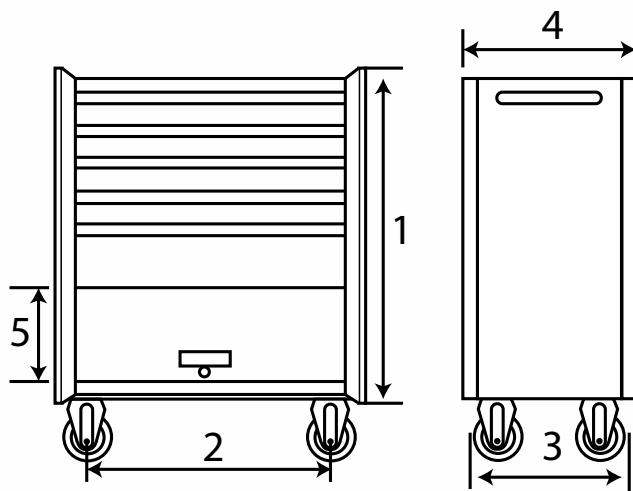

AIR TOOLS

HEX KEY

GENERAL TOOLS

CABINET 7 DRAWER

TROLI KABINET MEKANIK 7 LACI

ITEM CODE	SIZE	1 (mm)	2 (mm)	3 (mm)	4 (mm)	5 (mm)	WEIGHT (gr)	QTY / BOX INNER/MASTER
ST-RC1501	-	800	710	500	460	150	70,000	1 set

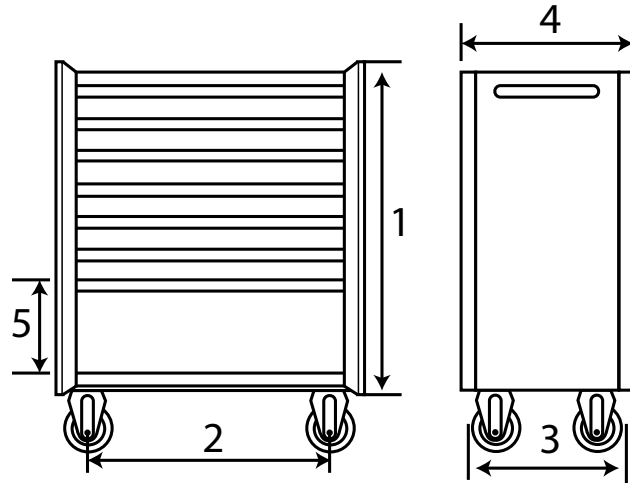

CONTENT

EVA ITEM CODE	EVA NAME
TY-PS1572	PLIERS SET
TY-CW1574	COMBINATION WRENCH SET
TY-SS1578	1/2" DR. SOCKET SET
TY-FN1580	FLARE NUT WRENCH SET
TY-SB1579	1/4" DR. SOCKET SET AND BALLPOINT HEX KEY WRENCH

CABINET 3 DRAWER SET 97 PCS

TROLI KABINET MEKANIK 3 LACI 97 PCS

ITEM CODE	SIZE	1 (mm)	2 (mm)	3 (mm)	4 (mm)	5 (mm)	WEIGHT (gr)	QTY / BOX INNER/MASTER
ST-RC1637	-	650	710	490	470	230	-	1 set

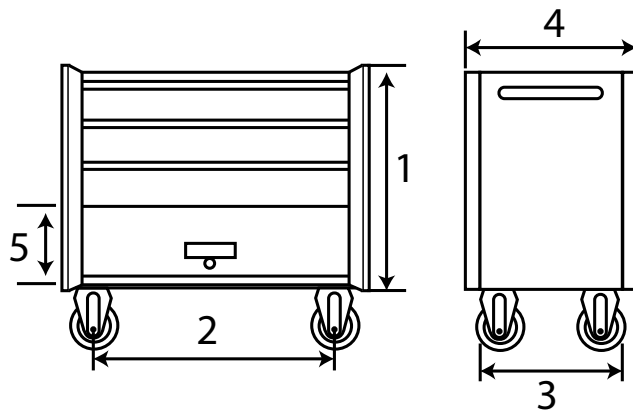

CABINET 5 DRAWER SET 97 PCS

TROLI KABINET MEKANIK 5 LACI 97 PCS

ITEM CODE	SIZE	1 (mm)	2 (mm)	3 (mm)	4 (mm)	5 (mm)	WEIGHT (gr)	QTY / BOX INNER/MASTER
ST-RC1638	-	800	710	500	460	150	-	1 set

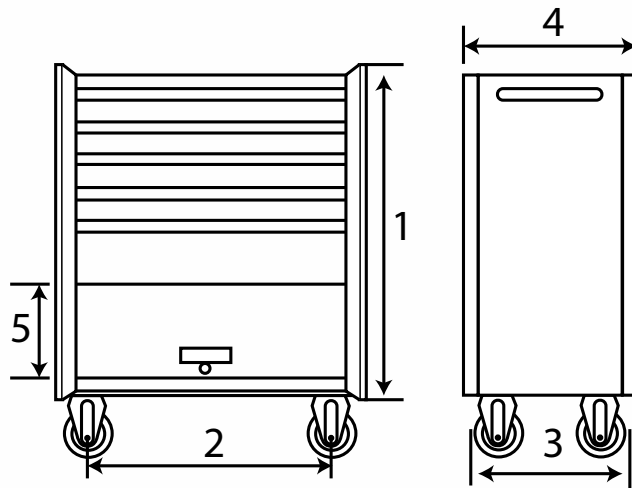

CONTENT

EVA ITEM CODE	EVA NAME
TY-PS1572	PLIERS SET
TY-CW1574	COMBINATION WRENCH SET
TY-BS1577	1/2" DR. BIT SOCKET SET
TY-FN1580	FLARE NUT WRENCH SET
TY-SB1579	1/4" DR. SOCKET SET AND BALLPOINT HEX KEY WRENCH
TY-CW1574	TPR GO THRU SCREWDRIVER SET
TY-SP1573	SNAP RING PLIERS



CABINET 7 DRAWER SET 136 PCS

TROLI KABINET MEKANIK 7 LACI 136 PCS

ITEM CODE	SIZE	1 (mm)	2 (mm)	3 (mm)	4 (mm)	5 (mm)	WEIGHT (gr)	QTY / BOX INNER/MASTER
ST-RC1639	-	800	710	500	460	150	-	1 set

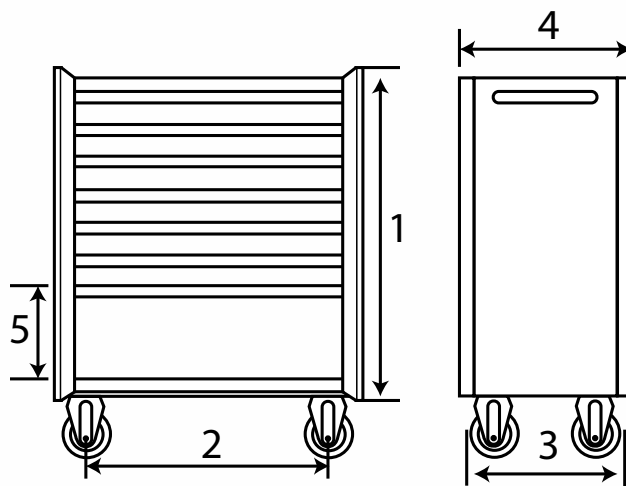

CONTENT

EVA ITEM CODE	EVA NAME
TY-PS1572	PLIERS SET
TY-SS1578	1/2" DR. SOCKET SET
TY-SB1579	1/4" DR. SOCKET SET AND BALLPOINT HEX KEY WRENCH
TY-FN1580	FLARE NUT WRENCH SET
TY-CW1574	COMBINATION WRENCH SET
TY-SS1564	TPR GO THRU SCREWDRIVER SET
TY-SW1567	STAR WRENCH SET
TY-MS1565	MEASUREMENT SET
TY-ID1568	IMPACT DRIVE
TY-OH1562	DOUBLE OPEN END AND HEX KEY WRENCH SET



CONTENT

EVA ITEM CODE	EVA NAME
TY-PS1572	PLIERS SET
TY-CW1574	COMBINATION WRENCH SET
TY-SS1578	1/2" DR. SOCKET SET
TY-FN1580	FLARE NUT WRENCH SET
TY-SP1573	SNAP RING PLIERS

CABINET 3 DRAWER SET 67 PCS
TROLI KABINET MEKANIK 3 LACI 67 PCS

ITEM CODE	SIZE	1 (mm)	2 (mm)	3 (mm)	4 (mm)	5 (mm)	WEIGHT (gr)	QTY / BOX INNER/MASTER
ST-RC1817	-	650	710	490	470	230	-	1 set

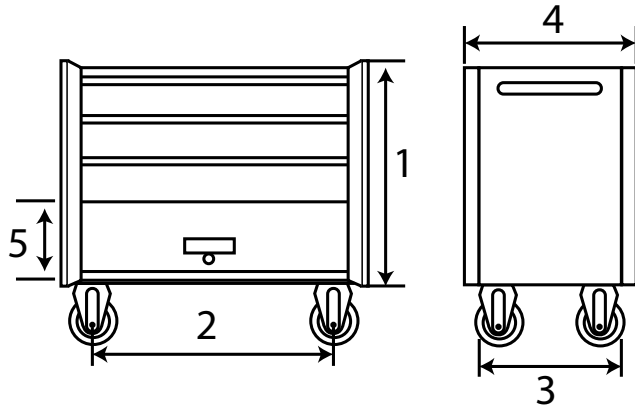
CONTENT

EVA ITEM CODE	EVA NAME
TY-PS1572	PLIERS SET
TY-CW1574	COMBINATION WRENCH SET
TY-SS1578	1/2" DR. SOCKET SET
TY-FN1580	FLARE NUT WRENCH SET
TY-SP1573	SNAP RING PLIERS

CABINET 5 DRAWER SET 67 PCS
TROLI KABINET MEKANIK 5 LACI 67 PCS

ITEM CODE	SIZE	1 (mm)	2 (mm)	3 (mm)	4 (mm)	5 (mm)	WEIGHT (gr)	QTY / BOX INNER/MASTER
ST-RC1809	-	800	710	500	460	150	-	1 set

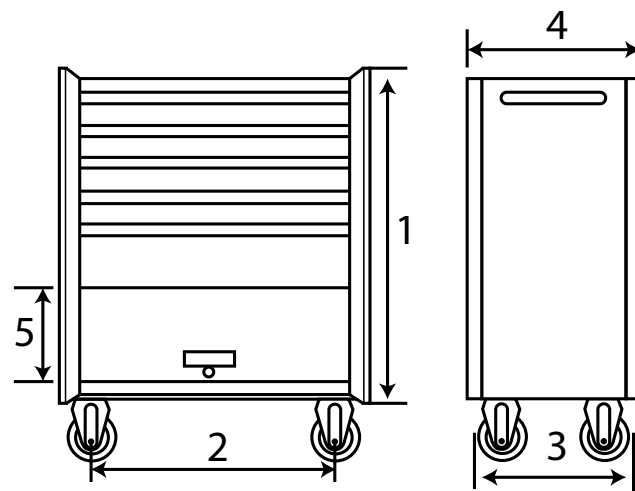

CABINET 5 DRAWER SET 80 PCS

TROLI KABINET MEKANIK 5 LACI 80 PCS

ITEM CODE	SIZE	1 (mm)	2 (mm)	3 (mm)	4 (mm)	5 (mm)	WEIGHT (gr)	QTY / BOX INNER/MASTER
ST-RC1830	-	800	710	500	460	150	-	1 set

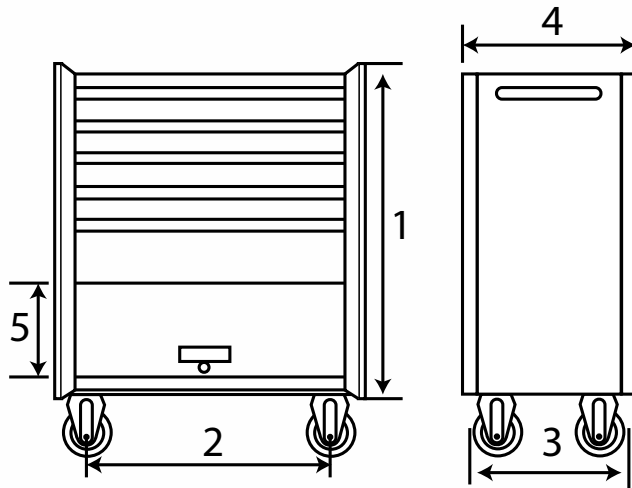

CONTENT

EVA ITEM CODE	EVA NAME
TY-PS1572	PLIERS SET
TY-SS1578	1/2" DR. SOCKET SET
TY-SB1579	1/4" DR. SOCKET SET AND BALLPOINT HEX KEY WRENCH
TY-FN1580	FLARE NUT WRENCH SET
TY-SS1564	TPR GO THRU SCREWDRIVER SET
TY-SP1573	SNAP RING PLIERS



CABINET 7 DRAWER SET 99 PCS

TROLI KABINET MEKANIK 7 LACI 99 PCS

ITEM CODE	SIZE	1 (mm)	2 (mm)	3 (mm)	4 (mm)	5 (mm)	WEIGHT (gr)	QTY / BOX INNER/MASTER
ST-RC1808	-	650	710	490	470	230	-	1 set

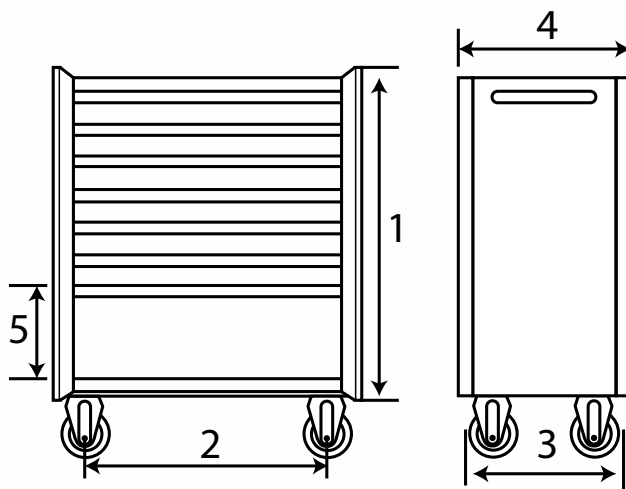

CONTENT

EVA ITEM CODE	EVA NAME
TY-OH1562	DOUBLE OPEN END AND HEX KEY WRENCH SET
TY-SS1564	TPR GO THRU SCREWDRIVER SET
TY-MS1565	MEASUREMENT SET
TY-SW1567	STAR WRENCH SET
TY-ID1568	IMPACT DRIVE
TY-PS1572	PLIERS SET
TY-CW1574	COMBINATION WRENCH SET
TY-SS1578	1/2" DR. SOCKET SET
TY-FN1580	FLARE NUT WRENCH SET
TY-SP1573	SNAP RING PLIERS





- Ball-bearing drawer slides for smooth movement
- Full extension removable drawers
- High quality material
- Specially developed for car/motorcycle mechanics
- Chest can be placed on top

TOOL CART BLACK

TROLI KERANJANG MEKANIK HITAM

ITEM CODE	SIZE	1 (mm)	2 (mm)	3 (mm)	4 (mm)	5 (mm)	6 (mm)	7 (mm)	8 (mm)	9 (mm)	WEIGHT (gr)	QTY / BOX INNER/MASTER
ST-TC1898	69 X 47 X 89	890	750	580	80	200	280	580	680	460	22,000	1 pcs

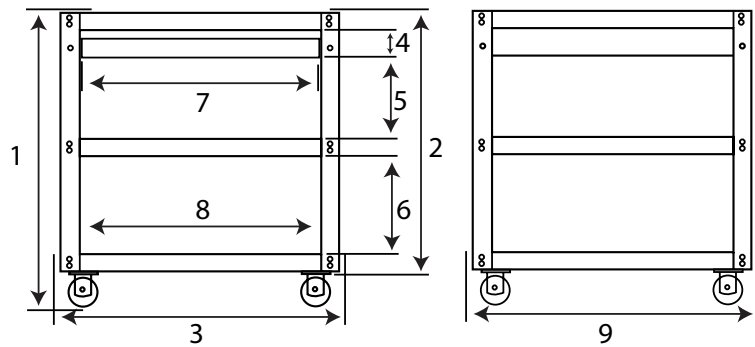



TOOL CART

TROLI KERANJANG MEKANIK

ITEM CODE	SIZE
ST - TC1832	69 X 47 X 89

1 (mm)	2 (mm)	3 (mm)	4 (mm)	5 (mm)	6 (mm)	7 (mm)	8 (mm)	9 (mm)	WEIGHT (gr)	QTY / BOX INNER/MASTER
890	750	680	80	200	280	580	680	460	22,000	1 pcs

- Ball-bearing drawer slides for smooth movement
- Full extension removable drawers
- High quality material
- Specially developed for car/motorcycle mechanics
- Chest can be placed on top

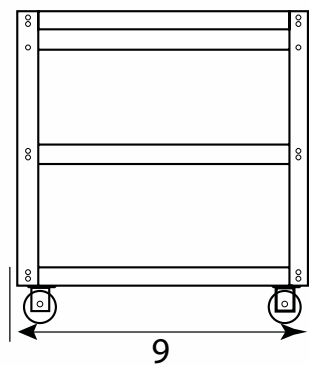
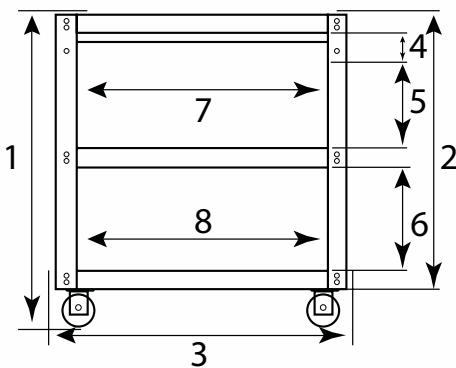

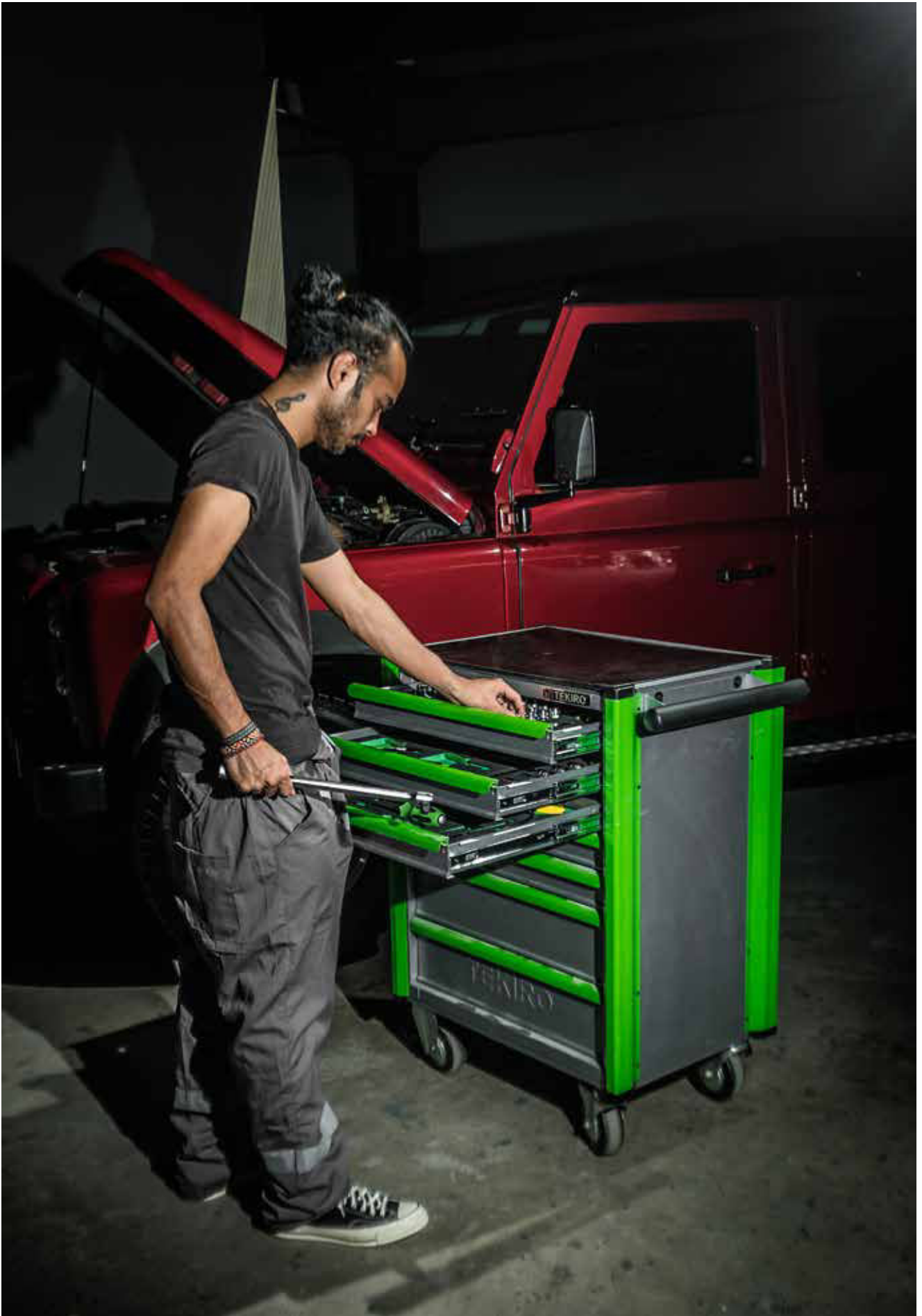



TRAY

Tekiro Tray sets are designed to fit into Tekiro Drawer Cabinets. We have 2 types of trays. Eva material and moulded hard plastic. Eva material is more expensive but gives a better protection to the tool while moulded hard plastic offers a more economical alternative to keep the tools organized.

EVA TRAY



PLASTIC TRAY



EVA ADJUSTABLE WRENCH, WATERPUMP AND PLIERS 10" SET

EVA KUNCI INGGRIS, TANG BURUNG, DAN TANG BUAYA 10" SET 3 PCS

ITEM CODE	CONTENT		WEIGHT (gr)	QTY / BOX INNER/MASTER
TY-AW1571	3 pcs	10" Adjustable Wrench	1,453	1 / 38 set
		10" Locking Pliers Curve		
		Water Pump Pliers Type A6 10"		



EVA 1/2" DR. BIT SOCKET SET

EVA 1/2" DR. BIT SOCKET SET 8 PCS

ITEM CODE	CONTENT		WEIGHT (gr)	QTY / BOX INNER/MASTER
TY-BS1577	8 pcs	1/2" DR. Hex Bit Socket Long Type 05 mm (SM)	859	1 / 35 set
		1/2" DR. Hex Bit Socket Long Type 06 mm (SM)		
		1/2" DR. Hex Bit Socket Long Type 08 mm (SM)		
		1/2" DR. Hex Bit Socket Long Type 10 mm (SM)		
		1/2" DR. Spline Socket Bit M9.5 X 100 mm		
		Torx key Set T40 long		
		Torx Key Set T45 Long		
		Torx Key Set T50 Long		



EVA CHISEL, ADJUSTABLE WRENCH, AND HACKSAW SET

EVA PAHAT, KUNCI INGGRIS, DAN GERGAJI BESI SET 9 PCS

ITEM CODE	CONTENT		WEIGHT (gr)	QTY / BOX INNER/MASTER
TY-CA1592	1 pcs	Adjustable Wrench 8"	1.500	1 / 25 set
	6 pcs	All Go Punch Chisel Set		
	1 pcs	Saw Blade 18 TPI		
	1 pcs	Hacksaw Frame With Aluminum Handle		



EVA CHISEL AND HAMMER SET

EVA PAHAT DAN PALU SET 9 PCS

ITEM CODE	CONTENT		WEIGHT (gr)	QTY / BOX INNER/MASTER
TY-CH1591	7 pcs	Punch and Chisel Set	1,850	1 / 20 set
	1 pcs	Ball Pein Hammer With Fibre 16 OZ		
	1 pcs	Double Plastic Hammer 30 mm		



EVA COMBINATION WRENCH SET

EVA KUNCI RING PAS SET 16 PCS



ITEM CODE	CONTENT		WEIGHT (gr)	QTY / BOX INNER/MASTER
TY-CW1574	14 pcs	Combination Wrench Set (8-24 mm)	2,217	1 / 20 set
	1 pcs	Combination Wrench 6 mm		
	1 pcs	Combination Wrench 7 mm		

EVA DEEP WALL AND OFFSET HANDLE

EVA MATA SOCK DEEP WALL DAN GAGANG SOCK L



ITEM CODE	CONTENT		WEIGHT (gr)	QTY / BOX INNER/MASTER
TY-DO1576	9 pcs	1/2" DR. Deep Wall Socket 6PT 8 mm	1,510	1 set
		1/2" DR. Deep Wall Socket 6PT 9 mm		
		1/2" DR. Deep Wall Socket 6PT 10 mm		
		1/2" DR. Deep Wall Socket 6PT 12 mm		
		1/2" DR. Deep Wall Socket 6PT 14 mm		
		1/2" DR. Deep Wall Socket 6PT 17 mm		
		1/2" DR. Deep Wall Socket 6PT 19 mm		
		1/2" DR. Deep Wall Socket 6PT 24 mm		
		1/2" DR. Offset Handle 10"		

EVA FLARE NUT WRENCH SET

EVA KUNCI NEPEL SET 4 PCS



ITEM CODE	CONTENT		WEIGHT (gr)	QTY / BOX INNER/MASTER
TY-FN1580	4 pcs	Flare Nut Wrench 8 X 10 mm	470	1 / 20 set
		Flare Nut Wrench 10 X 12 mm		
		Flare Nut Wrench 12 X 14 mm		
		Flare Nut Wrench 14 X 17 mm		

EVA HAMMER AND PIPE WRENCH

EVA PALU DAN KUNCI PIPA SET 2 PCS



ITEM CODE	CONTENT		WEIGHT (gr)	QTY / BOX INNER/MASTER
TY-HP1575	2 pcs	Claw Hammer 16 OZ	2,173	1 / 38
		pipe Wrench Without Rubber Handle 14"		

EVA IMPACT DRIVE

EVA OBENG KETOK SET 11 PCS

ITEM CODE	CONTENT	WEIGHT (gr)	QTY / BOX INNER/MASTER
TY-ID1568	1 pcs Impact Driver	1,136	1 / 38 set
	1 pcs Impact Bit Slotted 36 mm		
	1 pcs (-) 8.0 , 10.0		
	1 pcs Impact Bit Philips 36 mm		
	1 pcs (+) PH2, PH3		
	1 pcs Impact Bit Slotted 80 mm		
	1 pcs (-) 8.0 , 10.0		
	1 pcs Impact Bit Philips 80 mm		
	1 pcs (+) PH2, PH3		
	1 pcs Screw Extractor		
	1 pcs No.3 - 5/16" - 7/16" (M8-M11)		
1 pcs No.4 - 7/16" - 9/16" (M11-M14)			



EVA L T TYPE SET

EVA KUNCI TIPE L DAN T SET 7 PCS

ITEM CODE	CONTENT	WEIGHT (gr)	QTY / BOX INNER/MASTER
TY-LT1569	7 pcs T Shape Hex 2.5	1,100	1 / 15 set
	T Shape Hex 3		
	T Shape Hex 4		
	T Shape Hex 5		
	T Shape Hex 6		
	T Shape Hex 8		
	T Shape Hex 10		



EVA MEASUREMENT SET

EVA ALAT PENGUKUR SET 11 PCS

ITEM CODE	CONTENT	WEIGHT (gr)	QTY / BOX INNER/MASTER
TY-MS1565	11 pcs Measurement Tape 5 m	760	1 / 25 set
	Feller Gauge 0.05 mm - 1 mm		
	Cutter Knife 18 mm		
	Auto Voltage Tester		
	Screw Extractor Set 1/8" - 1"		
	Scraper 7.5"		



EVA OIL FILTER WRENCH BOWL SET

EVA KUNCI OLI FILTER (TIPE MANGKOK) SET 11 PCS

ITEM CODE	CONTENT	WEIGHT (gr)	QTY / BOX INNER/MASTER
TY-OF1593	5 pcs Oil Filter Wrench Bowl Type 64 mm	770	1 / 50
	Oil Filter Wrench Bowl Type 74 mm		
	Oil Filter Wrench Bowl Type 79 mm		
	Oil Filter Wrench Bowl Type 89 mm		
	Oil Filter Wrench Bowl Type 99 mm		



AUTOMOTIVE

STORAGE

TRAY

AIR TOOLS

HEX KEY

GENERAL TOOLS

EVA DOUBLE OPEN END AND HEX KEY WRENCH SET

EVA KUNCI PAS SET DAN KUNCI L SET 17 PCS



ITEM CODE	CONTENT		WEIGHT (gr)	QTY / BOX INNER/MASTER
TY-OH1562	9 pcs	BALL POINT HEX KEY SET (SHORT) 1.5 mm, 2 mm, 2.5 mm, 3 mm, 4 mm, 5 mm, 6 mm, 8 mm, 10 mm	1,380	1 / 25 set
	8 pcs	6 X 7, 8 X 9, 10 X 11, 12 X 13, 14 X 15, 16 X 17, 19 X 21, 22 X 24 mm		

EVA BOX END WRENCH SET

EVA KUNCI RING SET 8 PCS

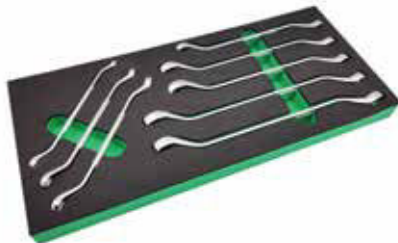

ITEM CODE	CONTENT		WEIGHT (gr)	QTY / BOX INNER/MASTER
TY-OR1570	8 pcs	Boxes end Wrench 06 X 07 mm	1.330	1 / 25 set
		Boxes end Wrench 08 X 09 mm		
		Boxes end Wrench 10 X 11 mm		
		Boxes end Wrench 12 X 13 mm		
		Boxes end Wrench 14 X 15 mm		
		Boxes end Wrench 16 X 17 mm		
		Boxes end Wrench 18 x 19 mm		
		Boxes end Wrench 20 x 22 mm		

EVA OBSTRUCTION WRENCH SET

EVA KUNCI RING BULAN SET 5 PCS



ITEM CODE	CONTENT		WEIGHT (gr)	QTY / BOX INNER/MASTER
TY-OW1566	5 pcs	Obstruction Wrench 10 X 12 mm	990	1 / 28 set
		Obstruction Wrench 11 X 13 mm		
		Obstruction Wrench 14 X 17 mm		
		Obstruction Wrench 16 X 18 mm		
		Obstruction Wrench 19 X 22 mm		

EVA PLIERS SET

EVA TANG SET 4 PCS



ITEM CODE	CONTENT		WEIGHT (gr)	QTY / BOX INNER/MASTER
TY-PS1572	4 pcs	Linesman Pliers 7"	964	1 / 20 set
		Diagonal Pliers 6"		
		Long Nose Pliers 6"		
		Slip Joint Pliers 6"		

EVA 1/4" DR. SOCKET SET AND BALLPOINT HEX KEY WRENCH

EVA 1/4" DR. SOCKET SET DAN KUNCI L BULAT SET 55 PCS

ITEM CODE	CONTENT	WEIGHT (gr)	QTY / BOX INNER/MASTER
TY-SB1579	13 pcs 1/4" DR. Hand Socket 4 mm, 4.5 mm, 5 mm, 5.5 mm, 6 mm, 7 mm, 8 mm, 9 mm, 10 mm, 11 mm 8 mm, 9 mm, 10 mm, 12 mm, 13 mm, 14 mm	1,609	1 / 23 set
	6 pcs 1/4" DR. Hex Bits Socket 37 mm H3, H4, H5, H6, H7, H8		
	6 pcs 1/4" DR. Torque Bits Socket 37 mm T10, T15, T20, T25, T30, T40		
	3 pcs 1/4" DR. Pozi Bits Socket 37 mm PZ1, PZ2, PZ3		
	3 pcs 1/4" DR. Philips Bits Socket 37 mm PH1, PH2, PH3		
	3 pcs 1/4" DR. Slotted Bits Socket 37 mm SL4, SL5, SL6		
	4 pcs Hex Key 1.27 mm, 1.5 mm, 2 mm, 2.5 mm		
	1 pcs 1/4" DR. Ratchet Handle 5.5" Rubber Handle 72 Teeth		
	1 pcs 1/4" DR. Universal Joint		
	1 pcs 1/4" DR. Spinner Handle (SM)		
	1 pcs 1/4" DR. Extension Bar 2"		
	1 pcs 1/4" DR. Extension Bar 4"		
	1 pcs 1/4" DR. Sliding T Handle 4"		
	1 pcs 1/4" DR. Flexible Handle 6" (SM)		
	1 pcs 1/4" x 1/4" Hex Adaptor		
	9 pcs BALL POINT HEX KEY SET (LONG) 1.5 mm, 2 mm, 2.5 mm, 3 mm, 4 mm, 5 mm, 6 mm, 8 mm, 10 mm		



EVA SNAP RING PLIERS 4 PCS

EVA TANG SNAP RING SET 4 PCS

ITEM CODE	CONTENT	WEIGHT (gr)	QTY / BOX INNER/MASTER
TY-SP1573	4 pcs Snap Ring Pliers EB 7" Snap Ring Pliers IB 7" Snap Ring Pliers ES 7" Snap Ring Pliers IS 7"	909	1 / 25 set



AUTOMOTIVE

STORAGE

TRAY

AIR TOOLS

HEX KEY

GENERAL TOOLS





AUTOMOTIVE

STORAGE

TRAY

AIR TOOLS

HEX KEY

GENERAL TOOLS

EVA TPR GO THRU SCREWDRIVER SET

EVA OBENG TPR TEMBUS SET 8 PCS



ITEM CODE	CONTENT		WEIGHT (gr)	QTY / BOX INNER/MASTER
TY-SS1564	8 pcs	TPR Go Thru Screwdriver (-) 5 X 75 mm	1,310	1 / 20 set
		TPR Go Thru Screwdriver (-) 6 X 100 mm		
		TPR Go Thru Screwdriver (-) 6 X 150 mm		
		TPR Go Thru Screwdriver (-) 8 X 200 mm		
		TPR Go Thru Screwdriver (+) PH1 X 75 mm		
		TPR Go Thru Screwdriver (+) PH2 X 100 mm		
		TPR Go Thru Screwdriver (+) PH2 X 150 mm		
		TPR Go Thru Screwdriver (+) PH3 X 200 mm		

EVA 1/2" DR. SOCKET SET

EVA 1/2" DR. SOCKET SET 24 PCS



ITEM CODE	CONTENT		WEIGHT (gr)	QTY / BOX INNER/MASTER	
TY-SS1578	18 pcs	1/2" DR. Hand Socket 6 PT	4,200	1 / 25 set	
		8 mm, 9 mm, 10 mm, 11 mm, 12 mm, 13 mm, 15 mm,			
		14 mm, 15 mm, 16 mm, 17 mm, 19 mm, 21 mm,			
		22 mm, 23 mm, 24 mm, 27 mm, 30 mm, 32 mm			
		1 pcs			1/2" DR. Ratchet Handle 10"
		1 pcs			1/2" DR. Extension Bar 5"
		1 pcs			1/2" DR. Extension Bar 10"
		1 pcs			1/2" DR. Flexible Handle 15"
1 pcs	1/2" DR. Sliding T Bar 10"				
1 pcs	1/2" DR. Universal Joint				

EVA STAR WRENCH SET

EVA KUNCI BINTANG SET 6 PCS



ITEM CODE	SIZE	CONTENT	WEIGHT (gr)	QTY / BOX INNER/MASTER
TY-SW1567	6 pcs	Star Wrench Set E6 - E24	678	1 / 20 set
		E6 X E8, E7 X E11, E10 X E12, E14 X E18, E16 X E22, E20 X E24		
		E16 X E22, E20 X E24		

EVA 1/2" AIR IMPACT TWIN HAMMER SET

EVA 1/2" DR. ALAT PEMBUKA BAUT TENAGA ANGIN TWIN HAMMER SET 12 PCS

ITEM CODE	CONTENT	WEIGHT (gr)	QTY / BOX INNER/MASTER
TY-AI1746	1/2" Air Impact Wrench Twin Hammer	5,000	1 / 4 set
	1/2" DR. Deep Impact Socket 6 PT 10 mm		
	1/2" DR. Deep Impact Socket 6 PT 12 mm		
	1/2" DR. Deep Impact Socket 6 PT 14 mm		
	1/2" DR. Deep Impact Socket 6 PT 17 mm		
	1/2" DR. Deep Impact Socket 6 PT 19 mm		
	1/2" DR. Deep Impact Socket 6 PT 21 mm		
	1/2" DR. Deep Impact Socket 6 PT 23 mm		
	1/2" DR. Deep Impact Socket 6 PT 24 mm		
	Mini Oiler		
	Oil Pot		
	Coupler		



EVA SINGLE GEAR WRENCH SET

EVA KUNCI GEAR SET

ITEM CODE	CONTENT	WEIGHT (gr)	QTY / BOX INNER/MASTER
TY-SG1563	Single gear Wrench 8 mm	1.112	1 / 25 set
	Single gear Wrench 10 mm		
	Single gear Wrench 11 mm		
	Single gear Wrench 12 mm		
	Single gear Wrench 13 mm		
	Single gear Wrench 14 mm		
	Single gear Wrench 17 mm		
	Single gear Wrench 19 mm		

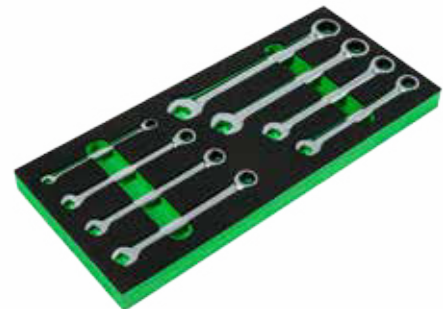

AUTOMOTIVE

STORAGE

TRAY

AIR TOOLS

HEX KEY

GENERAL TOOLS

YAMAHA TOOLS SET 55 PCS

EVA YAMAHA TOOLS SET 55 PCS



ITEM CODE	CONTENT	WEIGHT (gr)	QTY / BOX INNER/MASTER
	1 pcs Feller Gauge 0.05 mm - 1 mm TEKIRO		
	1 pcs 2 IN 1 Stubby Screwdriver TEKIRO		
	1 pcs Ratchet Screwdriver Handle		
	2 pcs Single Head Bits Philips PH1, PH3		
	1 pcs Single Head Bits Slotted SL6		
	5 pcs Single Head Bits Hex H2.5, H3, H4, H5, H6		
	1 pcs 3/8" DR. IMPACT BIT SOCKET 6 MM TEKIRO		
	1 pcs 3/8" Dr. Bit Socket Trox T50 TEKIRO		
	2 pcs 1/2" DR. IMPACT SOCKET 6 PT		
	24 mm, 27 mm		
	3 pcs 3/8" DR. IMPACT SOCKET 6 PT		
	17 mm, 19 mm, 22 mm		
	4 pcs 3/8" DR. DEEP IMPACT SOCKET 6 PT		
	8 mm, 10 mm, 12 mm, 14 mm		
	2 pcs TPR SCREWDRIVER		
	(-) 4 x 200 mm, (-) 3 x 7,5 mm		
	1 pcs 3/8" DR. UNIVERSAL JOINT (SM) TEKIRO		
	(BULK) MAGNETIC BIT DRIVER 1/4" WITH TAMPER PROOF T 27 TEKIRO		
	3 pcs 3/8" DR. EXTENSION BAR (SM)		
	3", 6", 10"		
AU-YT1631	1 pcs 3/8" DR. RATCHET HANDLE 8" RUBBER HANDLE 72 TEETH (SM) TEKIRO	8,500	1 set
	1 pcs 3/8" DR. SLIDING T BAR 8" (SM) TEKIRO		
	1 pcs (BULK) 3/8" DR. FLEXIBLE HANDLE 15" (SM) TEKIRO		
	1 pcs 3/8" DR. SPARK PLUG WITH MAGNET		
	16 mm, 18 mm, 21 mm		
	1 pcs VALVE ADJUSTABLE WRENCH TEKIRO		
	3 pcs TPR GO THRU SCREWDRIVER		
	(+) PH1 X 75 MM (5), (+) PH2 X 100 MM (6), (+) PH2 X 200 MM (6)		
	2 pcs TPR GO THRU SCREWDRIVER		
	(-) 6 X 100 MM, (-) 6 X 200 MM		
	2 pcs OPEN END WRENCH		
	6 X 7 MM, 8 X 10 MM		
	4 pcs COMBINATION WRENCH		
	10 mm, 12 mm, 14 mm, 19 mm		
	5 pcs BOXES END WRENCH 45 DEGREE		
	8 X 10 mm, 12 X 14 mm, 14 X 17 mm, 17 X 19 mm, 22 X 24 mm		
	1 pcs MAGNETIC TRAY 6"		
	1 pcs BALL PEIN HAMMER WITH FIBRE 16 OZ TEKIRO		
	1 pcs DOUBLE PLASTIC HAMMER 30MM TEKIRO		
	1 pcs SLIP JOINT PLIERS 8" TEKIRO		
	1 pcs DIAGONAL PLIERS 6" TEKIRO		
	1 pcs LONG NOSE PLIERS 6" TEKIRO		
	1 pcs TPR EXTRA LONG SCREWDRIVER (+) PH2 X 400 MM (6) TEKIRO		
	9 pcs BALL POINT HEX KEY SET (LONG)		
	1.5 mm, 2 mm, 2.5 mm, 3 mm, 4 mm, 5 mm, 6 mm, 8 mm, 10 mm		



AIR TOOLS

**AIR TOOLS
TEKIRO AIR LINE TOOLS DIAGRAM**

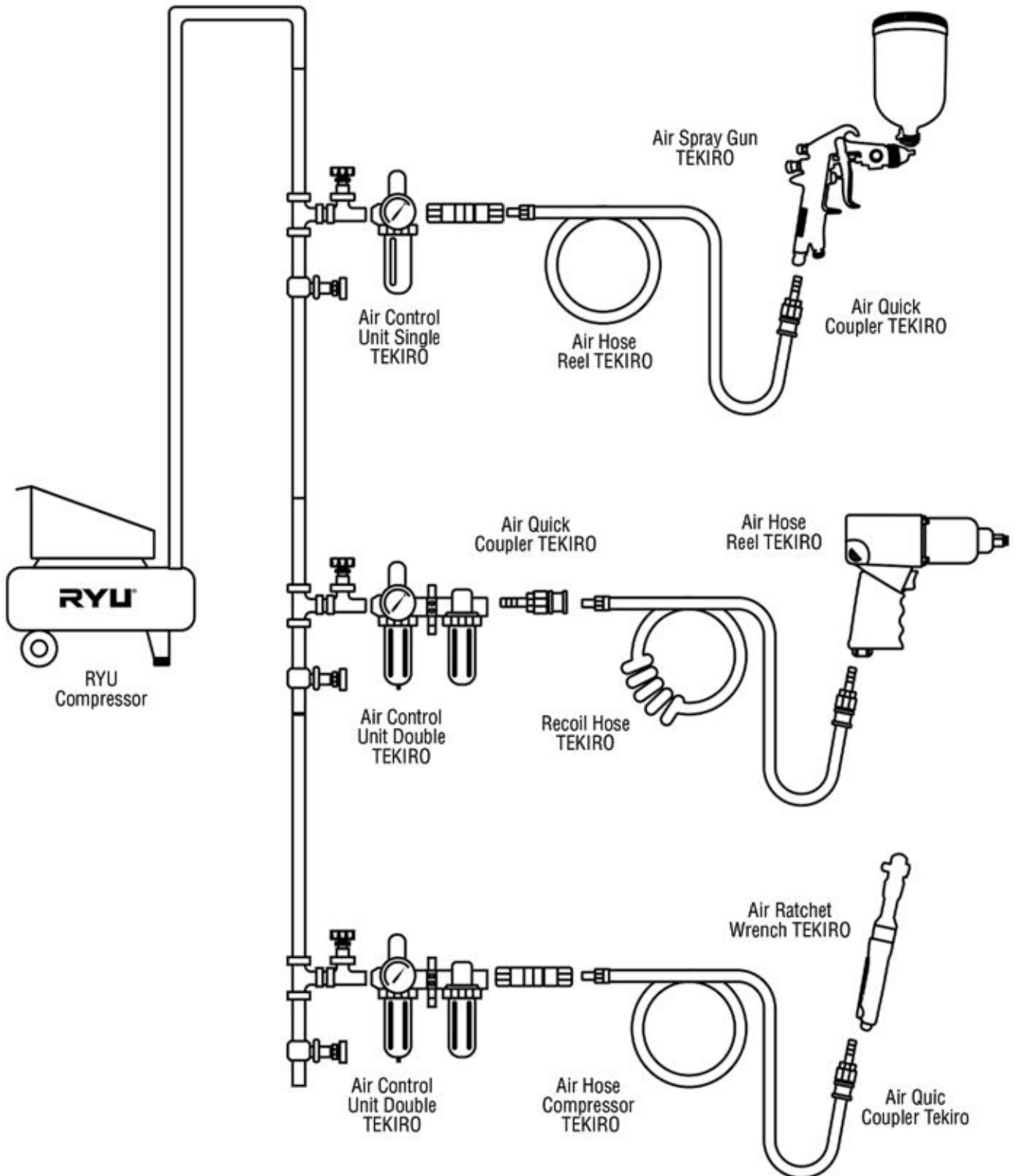

WWW.TEKIRO.COM

AIR TOOLS AIR QUICK COUPLER

TEKIRO air quick coupler is an industrial standard component for connecting air compressor systems used in automotive, agriculture, and industrial sectors. Made of (CrV) chrome vanadium material for durability, it exceeds the strictest requirement of Japanese Industrial Standard (JIS).

QUICK COUPLER ONE TOUCH

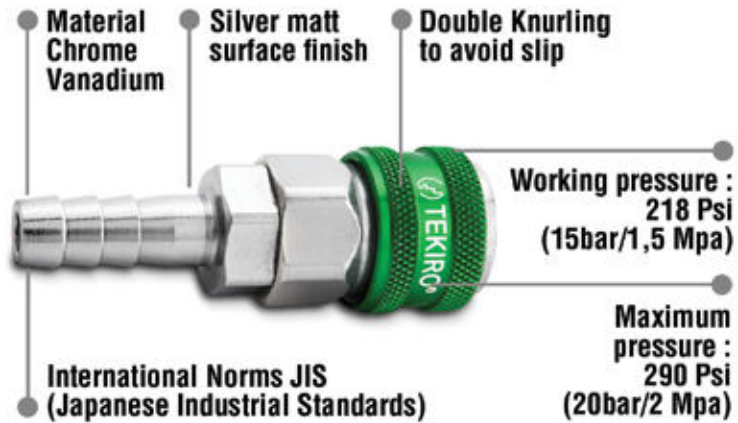

QUICK COUPLER TWO TOUCH

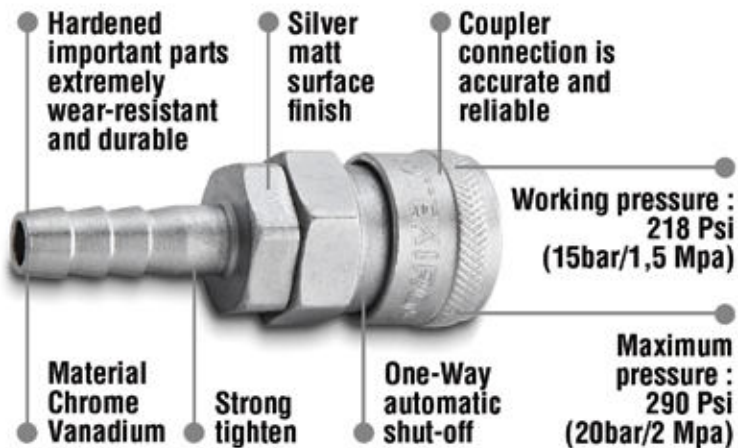

QUICK COUPLER PLUG

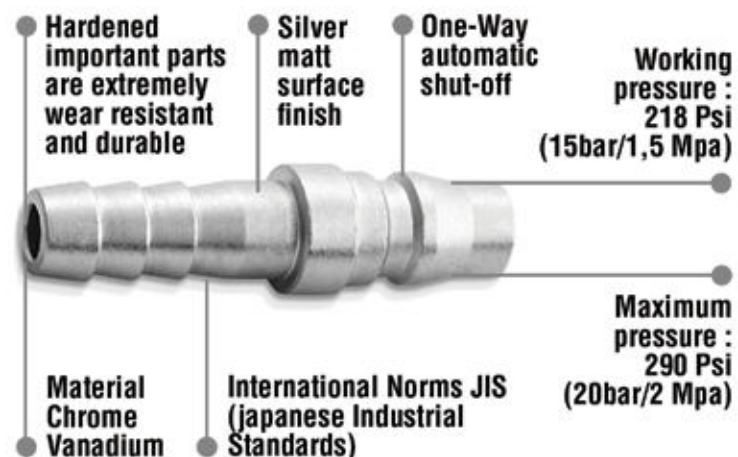

- Improved Operation
- Chrome Plated steel body for anti-corrosion
- One-touch series coupler could be widely applied for male and female thread connection, hose connectors and manifolds
- Meet the International Norms JIS (Japanese International Standard)

AIR QUICK COUPLER ONE TOUCH SF

COUPLER ANGIN SATU LANGKAH SF

ITEM CODE	SIZE	1 (mm)	2 (mm)	3 (mm)	4 (mm)	WEIGHT (gr)	QTY / BOX INNER/MASTER
AT-QC1074	20 SF	53	17	18	25	86	5 / 150 pcs
AT-QC1075	30 SF	34	17	20	21	89	5 / 150 pcs
AT-QC1076	40 SF	55	17	25	21	99	5 / 150 pcs

SPECIFICATION

Working Pressure	: 218psi (15bar/1,5Mpa)
Maximum Pressure	: 290psi (20bar/2Mpa)
Temperatur Range	: -20°C~ 80°C

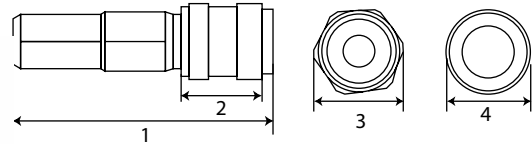

- Improved Operation
- Chrome Plated steel body for anti-corrosion
- One-touch series coupler could be widely applied for male and female thread connection, hose connectors and manifolds
- Meet the International Norms JIS (Japanese International Standard)

AIR QUICK COUPLER ONE TOUCH SH

COUPLER ANGIN SATU LANGKAH SH

ITEM CODE	SIZE	1 (mm)	2 (mm)	3 (mm)	4 (mm)	WEIGHT (gr)	QTY / BOX INNER/MASTER
AT-QC1077	20 SH	69	17	9	21	79	5 / 150 pcs
AT-QC1078	30 SH	72	17	11	26	83	5 / 150 pcs
AT-QC1079	40 SH	76	17	12	21	91	5 / 150 pcs

SPECIFICATION

Working Pressure	: 218psi (15bar/1,5Mpa)
Maximum Pressure	: 290psi (20bar/2Mpa)
Temperatur Range	: -20°C~ 80°C

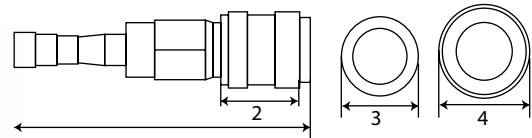

- Improved Operation
- Chrome Plated steel body for anti-corrosion
- One-touch series coupler could be widely applied for male and female thread connection, hose connectors and manifolds
- Meet the International Norms JIS (Japanese International Standard)

AIR QUICK COUPLER ONE TOUCH SM

COUPLER ANGIN SATU LANGKAH SM

ITEM CODE	SIZE	1 (mm)	2 (mm)	3 (mm)	4 (mm)	WEIGHT (gr)	QTY / BOX INNER/MASTER
AT-QC1080	20 SM	56	17	12	21	79	5 / 150 pcs
AT-QC1081	30 SM	56	17	13	22	79	5 / 150 pcs
AT-QC1082	40 SM	57	17	21	25	92	5 / 150 pcs

SPECIFICATION

Working Pressure	: 218psi (15bar/1,5Mpa)
Maximum Pressure	: 290psi (20bar/2Mpa)
Temperatur Range	: -20°C~ 80°C

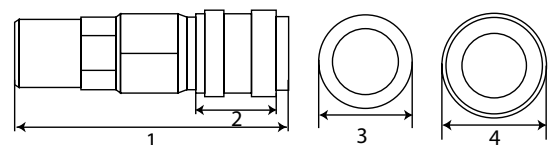

AIR QUICK COUPLER ONE TOUCH SP

COUPLER ANGIN SATU LANGKAH SP

ITEM CODE	SIZE	1 (mm)	2 (mm)	3 (mm)	4 (mm)	WEIGHT (gr)	QTY / BOX INNER/MASTER
AT-QC1083	20 SP	56	17	13	26	82	5 / 150 pcs
AT-QC1084	30 SP	56	17	25	21	102	5 / 150 pcs
AT-QC1085	40 SP	57	17	13	21	81	5 / 150 pcs

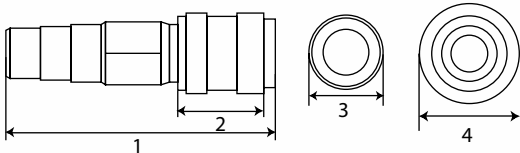

- Improved Operation
- Chrome Plated steel body for anti-corrosion
- One-touch series coupler could be widely applied for male and female thread connection, hose connectors and manifolds
- Meet the International Norms JIS (Japanese International Standard)

SPECIFICATION

Working Pressure	: 218psi (15bar/1,5Mpa)
Maximum Pressure	: 290psi (20bar/2Mpa)
Temperatur Range	: -20°C~ 80°C

AIR QUICK COUPLER TWO TOUCH SF

COUPLER ANGIN DUA LANGKAH SF

ITEM CODE	SIZE	1 (mm)	2 (mm)	3 (mm)	WEIGHT (gr)	QTY / BOX INNER/MASTER
AT-QC1086	20 SF	46	19	23	75	10 / 200 pcs
AT-QC1087	30 SF	47	20	23	79	10 / 200 pcs
AT-QC1088	40 SF	48	25	23	91	10 / 200 pcs

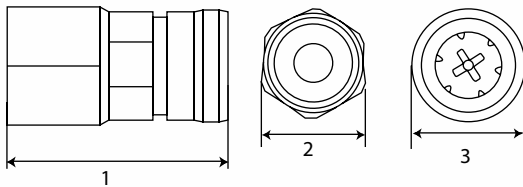

- Improved Operation
- Chrome Plated steel body for anti-corrosion
- Two-touch series coupler could be widely applied for male and female thread connection, hose connectors and manifolds
- Meet the International Norms JIS (Japanese International Standard)

SPECIFICATION

Working Pressure	: 218psi (15bar/1,5Mpa)
Maximum Pressure	: 290psi (20bar/2Mpa)
Temperatur Range	: -20°C~ 80°C

AIR QUICK COUPLER TWO TOUCH SH

COUPLER ANGIN DUA LANGKAH SH

ITEM CODE	SIZE	1 (mm)	2 (mm)	3 (mm)	WEIGHT (gr)	QTY / BOX INNER/MASTER
AT-QC1089	20 SH	62	9	23	67	10 / 200 pcs
AT-QC1090	30 SH	63	11	23	69	10 / 200 pcs
AT-QC1091	40 SH	67	12	23	90	10 / 200 pcs

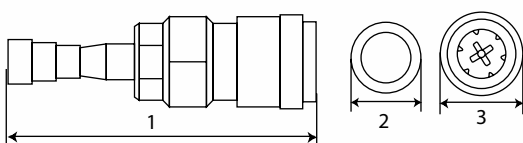

- Improved Operation
- Chrome Plated steel body for anti-corrosion
- Two-touch series coupler could be widely applied for male and female thread connection, hose connectors and manifolds
- Meet the International Norms JIS (Japanese International Standard)

SPECIFICATION

Working Pressure	: 218psi (15bar/1,5Mpa)
Maximum Pressure	: 290psi (20bar/2Mpa)
Temperatur Range	: -20°C~ 80°C

- Improved Operation
- Chrome Plated steel body for anti-corrosion
- Two-touch series coupler could be widely applied for male and female thread connection, hose connectors and manifolds
- Meet the International Norms JIS (Japanese International Standard)

SPECIFICATION

Working Pressure	: 218psi (15bar/1,5Mpa)
Maximum Pressure	: 290psi (20bar/2Mpa)
Temperatur Range	: -20°C~ 80°C

AIR QUICK COUPLER TWO TOUCH SM

COUPLER ANGIN DUA LANGKAH SM

ITEM CODE	SIZE	1 (mm)	2 (mm)	3 (mm)	WEIGHT (gr)	QTY / BOX INNER/MASTER
AT-QC1092	20 SM	48	13	23	67	10 / 200 pcs
AT-QC1093	30 SM	49	16	23	71	10 / 200 pcs
AT-QC1094	40 SM	50	20	23	82	10 / 200 pcs

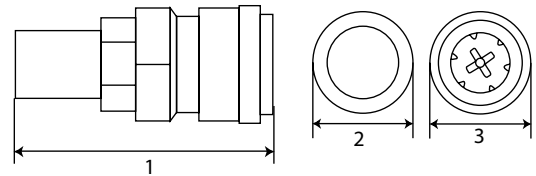

- Improved Operation
- Chrome Plated steel body for anti-corrosion
- Two-touch series coupler could be widely applied for male and female thread connection, hose connectors and manifolds
- Meet the International Norms JIS (Japanese International Standard)

SPECIFICATION

Working Pressure	: 218psi (15bar/1,5Mpa)
Maximum Pressure	: 290psi (20bar/2Mpa)
Temperatur Range	: -20°C~ 80°C

AIR QUICK COUPLER TWO TOUCH SP

COUPLER ANGIN DUA LANGKAH SP

ITEM CODE	SIZE	1 (mm)	2 (mm)	3 (mm)	WEIGHT (gr)	QTY / BOX INNER/MASTER
AT-QC1095	20 SP	48	12	23	68	10 / 200 pcs
AT-QC1096	30 SP	50	14	23	74	10 / 200 pcs
AT-QC1097	40 SP	54	17	23	82	10 / 200 pcs

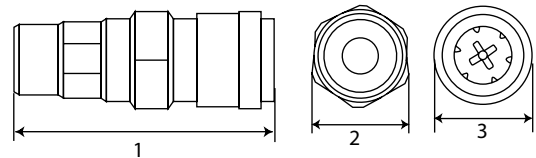

- One-Way automatic shut-off in the socket
- Wide Variety provides choice accordingly to application
- Hardened important parts are extremely wear resistant and durable
- Tested 100.000 Times, coupler connection is accurate and reliable
- Meet the International Norms JIS (Japanese International Standard)

SPECIFICATION

Working Pressure	: 218psi (15bar/1,5Mpa)
Maximum Pressure	: 290psi (20bar/2Mpa)
Temperatur Range	: -20°C~ 80°C

AIR QUICK COUPLER PLUG PF

COUPLER ANGIN PLUG PF

ITEM CODE	SIZE	1 (mm)	2 (mm)	3 (mm)	WEIGHT (gr)	QTY / BOX INNER/MASTER
AT-QC1098	20 PF	37	10	17	29	20 / 400 pcs
AT-QC1099	30 PF	39	10	20	38	20 / 400 pcs
AT-QC1100	40 PF	40	10	24	51	20 / 400 pcs

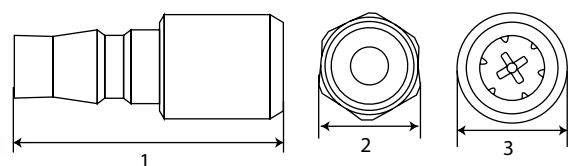

AIR QUICK COUPLER PLUG PH

COUPLER ANGIN PLUG PH

ITEM CODE	SIZE	1 (mm)	2 (mm)	3 (mm)	WEIGHT (gr)	QTY / BOX INNER/MASTER
AT-QC1101	20 PH	53	10	10	24	20 / 400 pcs
AT-QC1102	30 PH	55	10	10	30	20 / 400 pcs
AT-QC1103	40 PH	55	10	10	30	20 / 400 pcs

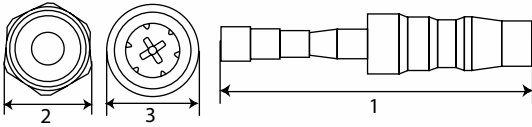

- One-Way automatic shut-off in the socket
- Wide Variety provides choice accordingly to application
- Hardened important parts are extremely wear resistant and durable
- Tested 100.000 Times, coupler connection is accurate and reliable
- Meet the International Norms JIS (Japanese International Standard)

SPECIFICATION

Working Pressure	: 218psi (15bar/1,5Mpa)
Maximum Pressure	: 290psi (20bar/2Mpa)
Temperatur Range	: -20°C~ 80°C

AIR QUICK COUPLER PLUG PM

COUPLER ANGIN PLUG PM

ITEM CODE	SIZE	1 (mm)	2 (mm)	3 (mm)	WEIGHT (gr)	QTY / BOX INNER/MASTER
AT-QC1104	20 PM	41	13	11	25	20 / 400 pcs
AT-QC1105	30 PM	42	10	16	37	20 / 400 pcs
AT-QC1106	40 PM	42	10	19	42	20 / 400 pcs

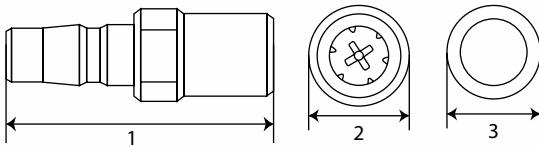

- One-Way automatic shut-off in the socket
- Wide Variety provides choice accordingly to application
- Hardened important parts are extremely wear resistant and durable
- Tested 100.000 Times, coupler connection is accurate and reliable
- Meet the International Norms JIS (Japanese International Standard)

SPECIFICATION

Working Pressure	: 218psi (15bar/1,5Mpa)
Maximum Pressure	: 290psi (20bar/2Mpa)
Temperatur Range	: -20°C~ 80°C

AIR QUICK COUPLER PLUG PP

COUPLER ANGIN PLUG PP

ITEM CODE	SIZE	1 (mm)	2 (mm)	3 (mm)	WEIGHT (gr)	QTY / BOX INNER/MASTER
AT-QC1107	20 PP	40	10	13	25	20 / 400 pcs
AT-QC1108	30 PP	42	10	14	32	20 / 400 pcs
AT-QC1109	40 PP	45	10	17	50	20 / 400 pcs

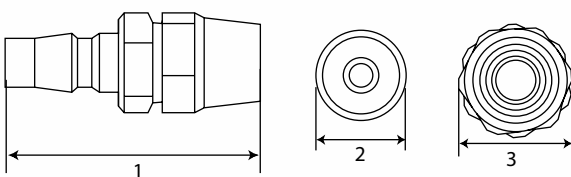

- One-Way automatic shut-off in the socket
- Wide Variety provides choice accordingly to application
- Hardened important parts are extremely wear resistant and durable
- Tested 100.000 Times, coupler connection is accurate and reliable
- Meet the International Norms JIS (Japanese International Standard)

SPECIFICATION

Working Pressure	: 218psi (15bar/1,5Mpa)
Maximum Pressure	: 290psi (20bar/2Mpa)
Temperatur Range	: -20°C~ 80°C

- Wide Variety provides choice accordingly to application
- Hardened important parts are extremely wear resistant and durable
- Tested 100.000 Times, coupler connection is accurate and reliable
- Meet the International Norms JIS (Japanese International Standard)

AIR QUICK COUPLER 2 WAY

COUPLER ANGIN CABANG 2

ITEM CODE	SIZE	1 (mm)	2 (mm)	3 (mm)	4 (mm)	5 (mm)	WEIGHT (gr)	QTY / BOX INNER/MASTER
AT-QC1674	2 Way	35	35	35	13	14	226	1 / 27 pcs

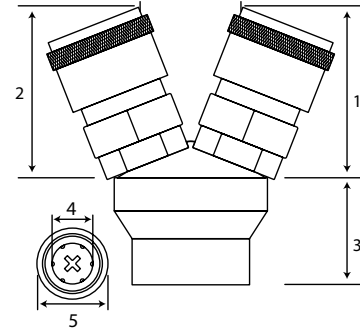

SPECIFICATION

Working Pressure	: 218psi (15bar/1,5Mpa)
Maximum Pressure	: 290psi (20bar/2Mpa)
Temperatur Range	: -20°C~ 80°C

- Wide Variety provides choice accordingly to application
- Hardened important parts are extremely wear resistant and durable
- Tested 100.000 Times, coupler connection is accurate and reliable
- Meet the International Norms JIS (Japanese International Standard)

AIR QUICK COUPLER 3 WAY

COUPLER ANGIN CABANG 3

ITEM CODE	SIZE	1 (mm)	2 (mm)	3 (mm)	4 (mm)	5 (mm)	WEIGHT (gr)	QTY / BOX INNER/MASTER
AT-QC1675	3 Way	35	35	35	13	23	256	1 / 27 pcs

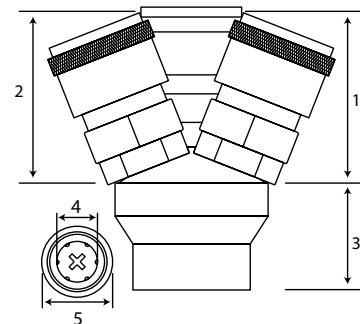

SPECIFICATION

Working Pressure	: 218psi (15bar/1,5Mpa)
Maximum Pressure	: 290psi (20bar/2Mpa)
Temperatur Range	: -20°C~ 80°C

AIR QUICK COUPLER 4 WAY

COUPLER ANGIN CABANG 4

ITEM CODE	SIZE	1 (mm)	2 (mm)	3 (mm)	4 (mm)	5 (mm)	WEIGHT (gr)	QTY / BOX INNER/MASTER
AT-QC1676	4 Way	30	30	122	13	23	369	1 / 35 pcs

- Wide Variety provides choice accordingly to application
- Hardened important parts are extremely wear resistant and durable
- Tested 100.000 Times, coupler connection is accurate and reliable
- Meet the International Norms JIS (Japanese International Standard)

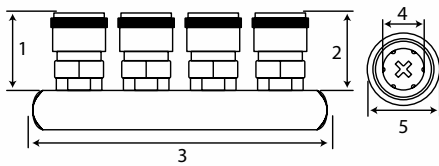

SPECIFICATION

Working Pressure	: 218psi (15bar/1,5Mpa)
Maximum Pressure	: 290psi (20bar/2Mpa)
Temperatur Range	: -20°C~ 80°C

ENGINE CLEANING GUN

ALAT SEMPROTAN ANGIN PEBERSIH MESIN

ITEM CODE	SIZE	1 (mm)	2 (mm)	3 (mm)	4 (mm)	5 (mm)	6 (mm)	WEIGHT (gr)	QTY / BOX INNER/MASTER
AT-CG1110	15'	245	12	35	144	6	1,200	296	1 / 50 pcs

- Material Chrome Vanadium
- All purpose spray cleaning ability
- Extended wand gets into hard to reach places
- Adjustable solvent flow
- Working Pressure 90~120 psi

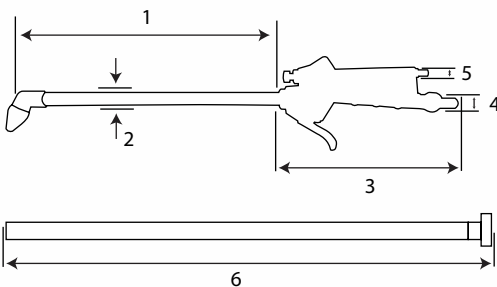



AIR TOOLS AIR DUSTER GUN

TEKIRO Air Duster gun is made of high quality alloy material, sturdy, safe, corrosion resistant and durable to use. Corrosion resistant materials make the compressed air perfect for cleaning automotive components, eliminating water, dust and dirt.

- Powerful airflow, low consumption and every saving
- Thin and long nozzle able to generate fast and narrow air flow that could reach into deep holes and narrow slits that is difficult to clean



Wide range of applications
widely use for blowing dust, water, powder, debris and various industrial or household cleanup and blow-off operations.



Working Site Blow Off
ideal for carpentry workplace and industrial workshop dust or powders blow off.



Working Site Blow Off
Thin and Long nozzle, ideal for carpentry workplace and industrial workshop dust or powders blow off.

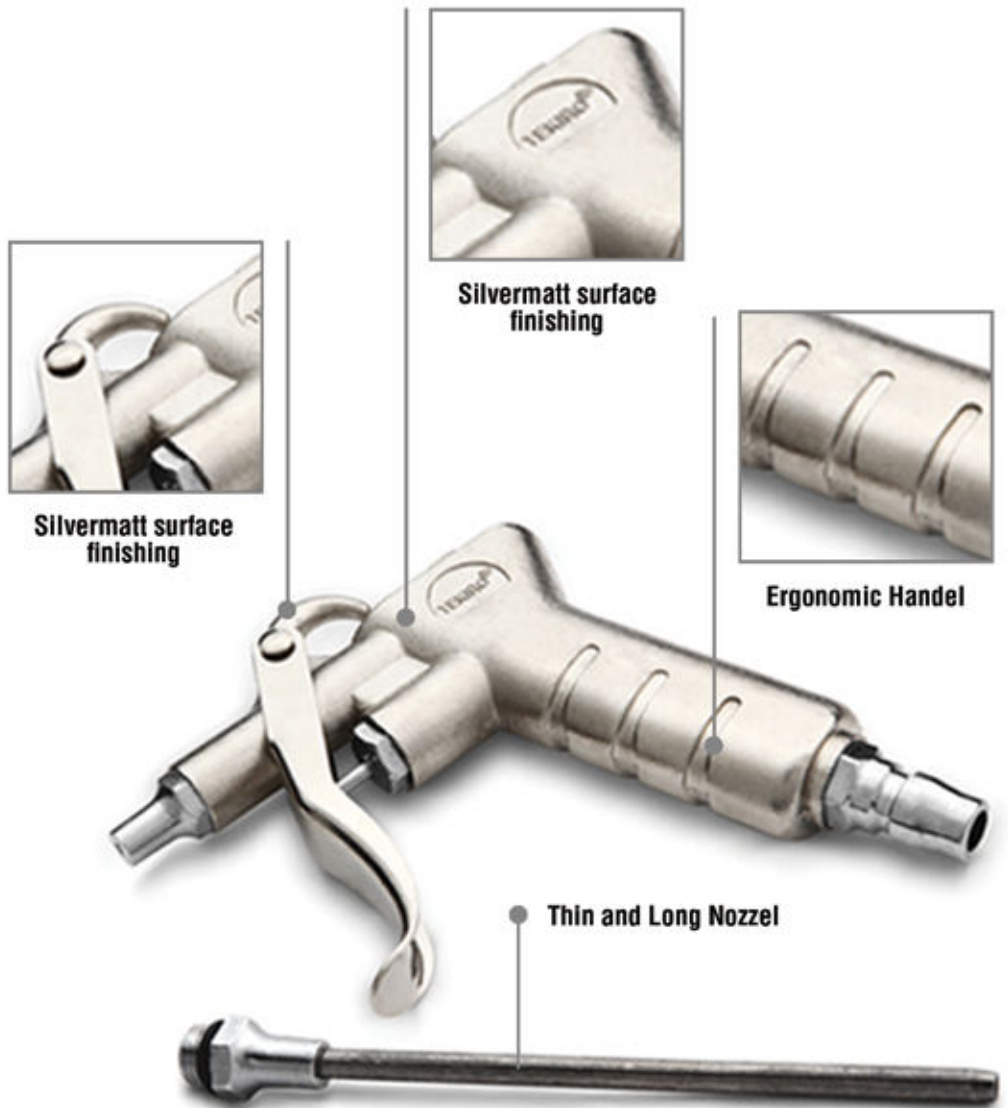

AIR DUSTER GUN

SEMPROTAN ANGIN 2 FUNGSI

ITEM CODE	SIZE	1 (mm)	2 (mm)	3 (mm)	4 (mm)	5 (mm)	AIR INLET (inch)	WEIGHT (gr)	QTY / BOX INNER/MASTER
AT-AD1111	DG1-3	120	5	26	123	8	1/4	190	10 / 100 pcs

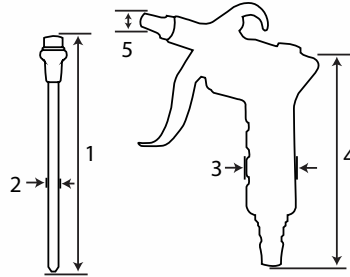

- The air blow gun uses high quality alloy material, sturdy, safe, antirust and durable to use
- Powerful air flow, low consumption and energy-saving
- Thin and long nozzle able to generate fast and narrow air flow that could reach into deep holes and narrow slits that is difficult to clean



AIR WASHING GUN

ALAT SEMPROTAN ANGIN PEBERSIH MESIN TABUNG

ITEM CODE	SIZE	1 (mm)	2 (mm)	3 (mm)	4 (mm)	AIR INLET (inch)	WEIGHT (gr)	QTY / BOX INNER/MASTER
AT-WG1112	500 cc	211	106	360	12	1/4	438	1 / 10 pcs

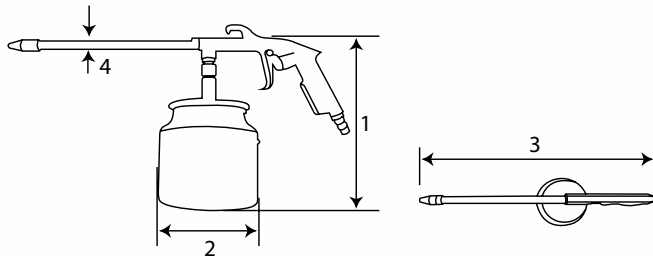

- Alloy structure body. Fits for 1/4" diameter
- Powerful blowing, low consumption and energy-saving
- Thin and long nozzle able to generate fast and narrow air flow that could reach into deep holes and narrow slits that is difficult to clean
- Rated pressure: 90psi
- Max. pressure: 150psi



AIR BLOW GUN

SEMPROTAN ANGIN

ITEM CODE	SIZE	1 (mm)	2 (mm)	3 (mm)	4 (mm)	5 (mm)	6 (mm)	WEIGHT (gr)	QTY / BOX INNER/MASTER
AT-BG1627	5"	231	137	98	40	13	10	194	20 / 100 pcs
AT-BG1628	12"	391	266	132	40	12	11	267	15 / 75 pcs

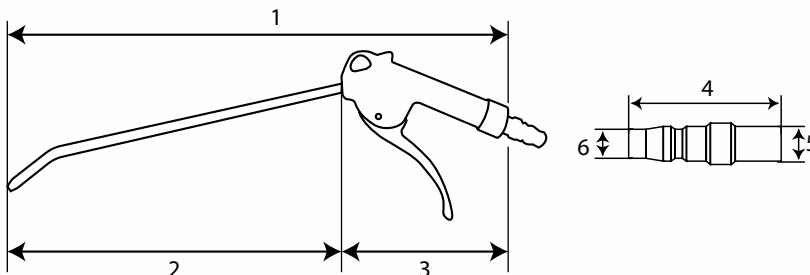

- Full pressure nozzle
- Super-gripping handle
- Ideal for quick cleaning
- Working Pressure 170psi



AIR TOOLS COMPRESSED AIR HOSE

TEKIRO compressed air hoses are specifically manufactured to transfer high pressure gases. It comes in a range of sizes and length with different temperatures and pressures. Understanding the maximum values within an intended application of an air hose is critical in ensuring safety for the user and longevity in the hose. The flexibility of Tekiro compressed air hoses allow the user to work freely in or around most circumstances or can fix the hoses in place around a workstation without the need for angle or corner connectors.



Rubber and copper material



Outer material with abrasion resistant



RECOIL HOSE GREEN

The **TEKIRO** recoil hose with spring is perfect for installations requiring flexibility in confined spaces and all-weather flexibility. Good resistance to shock and abrasion, together with a design integrating straight ends, allow for the easy and safe operation of pneumatic equipment.



Installed Quick Coupler, Plug and Bend Restrictors

Installed 1/4" quick coupler and plug for directly to connect air compressor and air tools. The bend restrictors to reduce kinking and to increase the life of the hose.



Self-Coiling

Self-recoils after extension during use for save your spacing



Flexible all weather

Excellent polyurethane material offers flexibility in all weather even at -40 to +150 degree F

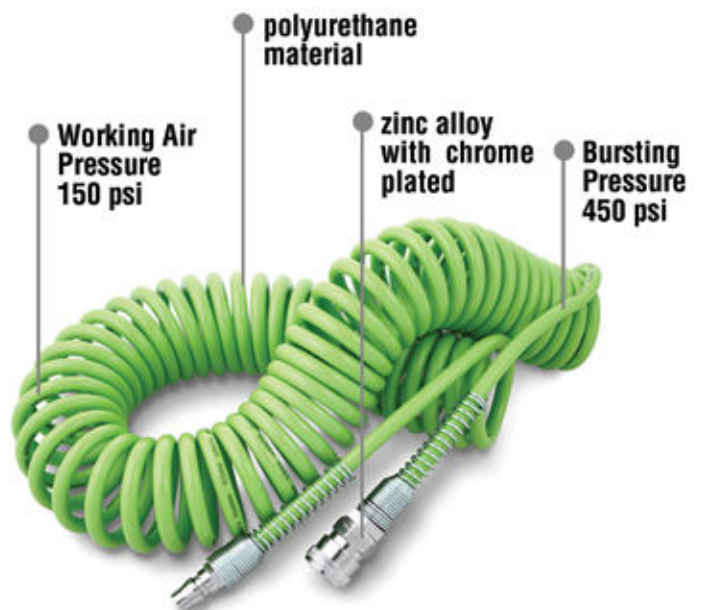

RECOIL HOSE WITH SPRING (GREEN COLOUR)

SELANG ANGIN SPIRAL HIJAU

ITEM CODE	SIZE	1 (mm)	2 (mm)	WORKING PRESSURE (Psi)	BURST PRESSURE (Psi)	WEIGHT (gr)	QTY / BOX INNER/MASTER
AT-RH1115	6 m (5 X 8 mm)	300	50	150	450	350	48 pcs
AT-RH1116	9 m (5 X 8 mm)	450	50	150	450	461	36 pcs
AT-RH1117	12 m (5 X 8 mm)	600	50	150	450	590	36 pcs
AT-RH1118	15 m (5 X 8 mm)	750	50	150	450	694	30 pcs
AT-RH1123	6 m (8 X 12 mm)	300	80	135	400	656	40 pcs
AT-RH1124	9 m (8 X 12 mm)	500	80	135	400	887	25 pcs
AT-RH1125	12 m (8 X 12 mm)	660	80	135	400	1,130	20 pcs

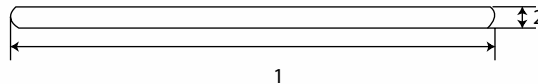

- Hose I.D : 5 mm, O.D : 8 mm
- Hose material : polyurethane
- Coupler : zinc alloy with chrome plated
- Working temperature : -20°C ~ 60°C



RECOIL HOSE WITH SPRING (YELLOW COLOUR)

SELANG ANGIN SPIRAL KUNING

ITEM CODE	SIZE	1 (mm)	2 (mm)	WORKING PRESSURE (Psi)	BURST PRESSURE (Psi)	WEIGHT (gr)	QTY / BOX INNER/MASTER
AT-RH1119	6 m (5 x 6 mm)	300	50	150	450	348	48 pcs
AT-RH1120	9 m (5 x 6 mm)	450	56	150	450	454	36 pcs
AT-RH1121	12 m	600	51	150	450	592	36 pcs
AT-RH1122	15 m	750	57	150	450	667	30 pcs

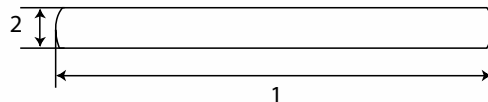

- Hose I.D : 5 mm, O.D : 6 mm
- Hose material : polyurethane
- Coupler : zinc alloy with chrome plated
- Working temperature : -20°C ~ 60°C



AIR HOSE REEL

SELANG ANGIN GULUNGAN

ITEM CODE	SIZE	1 (mm)	2 (mm)	3 (mm)	4 (mm)	WEIGHT (gr)	QTY / BOX INNER/MASTER
AT-AH1625	6 M	280	133	26	12	20,000	1 / 5 pcs

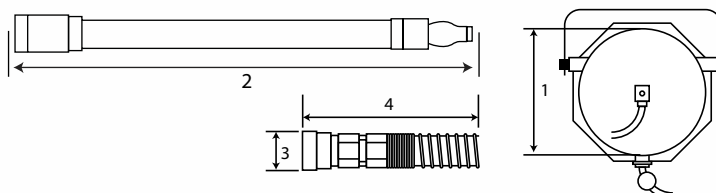

- High quality impact resistant
- PU Hose material
- Strong handle swivel bracket



- Outer material with abrasion resistant
- Flexible and easy to handle
- Can supply liquid fertilizer
- Coupling (flexible, 13.8 thread)

COMPRESSED AIR HOSE

SELANG TEKANAN TINGGI

ITEM CODE	SIZE	1 (mm)	WORKING PRESSURE (bar)	BURST PRESSURE (bar)	WEIGHT (gr)	QTY / BOX INNER/MASTER
AT-AH1622	8.5 X 14 mm (10 M)	13	60	200	1,520	1 / 6 pcs
AT-AH1621	8.5 X 14 mm (100 M)	14	60	200	15,200	1 / 1 pcs
AT-AH1776	8.5 X 15 mm (20 M)	15	60	200	2,883	1 / 6 pcs
AT-AH1777	8.5 X 15 mm (50 M)	15	60	200	8,000	1 / 1 pcs



- 20 L Large Tank Capacity
- Suitable for grease #1 - #3
- Steel material tank
- Easy greasing at high pressure

AIR LUBRICATOR FOR GREASE

POMPA GEMUK TENAGA ANGIN

ITEM CODE	SIZE	1 (mm)	2 (mm)	3 (mm)	4 (mm)	5 (mm)	6 (mm)	WEIGHT (gr)	QTY / BOX INNER/MASTER
AT-AL1128	20 L	117	121	430	350	310	1,200	17 kg	1 set



SPECIFICATION

Max. output capacity	: 30 c.c./sec
Max. output pressure	: 180 - 405 kg/cm ²
Shank length pump	: 430 mm
Max-min air pressure	: 4 - 9 kg/cm ²

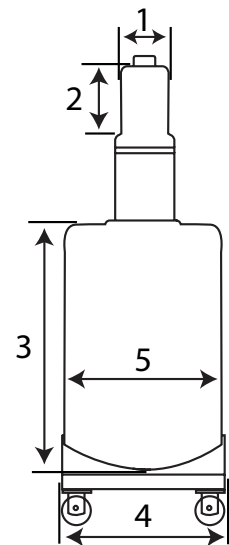
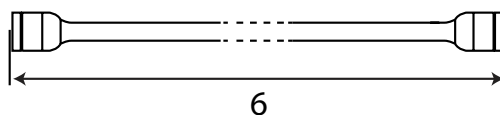



AUTOMOTIVE

STORAGE

TRAY

AIR TOOLS

HEX KEY

GENERAL TOOLS

AIR SCREWDRIVER

TEKIRO Air Screwdriver is ideal for high furniture and car production lines. This provides durability, power and speed for assembly and manufacturing applications with affordable opportunities. This increases productivity and improves product quality through precision torque control and user comfort. Ergonomic design allows users to work for long periods without fatigue.

- Ergonomic design of the industrial air screwdriver highly reduce fatigues while deliver the best performance.
- Equipped with screw head quick connector: 1/4" (6.35mm) ensures that bit won't drop accidentally, easy to operate.
- Forward reverse switch controls the bit to move clockwise or anticlockwise, so people can install or remove the screw conveniently



FORWARD REVERSE SWITCH

Forward reverse switch controls the bit to move clockwise or anticlockwise, so people can install or remove the screw conveniently.



PRESS SWITCH

Press switch allows people to start and stop the screwdriver easily.



SELF LOCKING HEAD

The 1/4" self locking head ensures that bit won't drop accidentally.

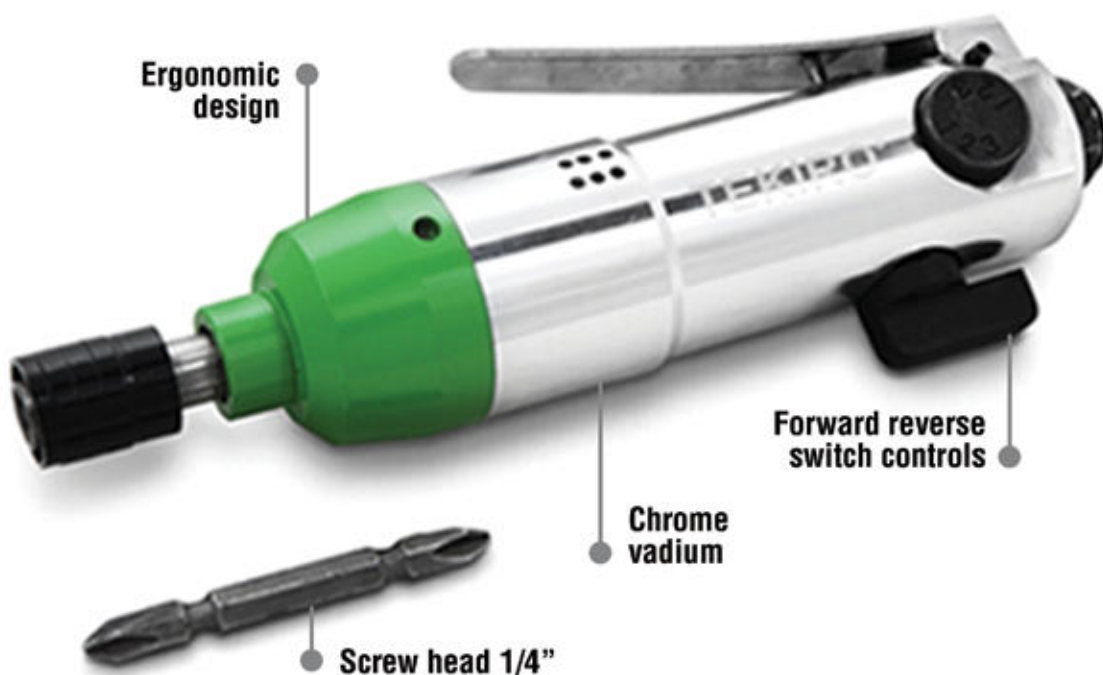

HEAVY DUTY AIR DIE GRINDER

1/4" DR. GERINDA TENAGA ANGIN

ITEM CODE	SIZE	1 (mm)	2 (mm)	3 (mm)	4 (mm)	5 (mm)	6 (mm)	WEIGHT (gr)	QTY / BOX INNER/MASTER
AT-AG1629	1/4"	169	28	37	119	32	24	543.0	1 / 25 pcs

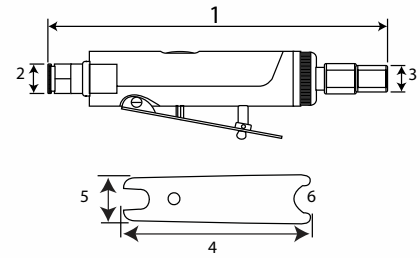

SPECIFICATION

Collet Size	: 1/4"
Length	: 6"
Free Speed	: 25,000rpm
Weight	: 3/4 lbs
Overall Length	: 5-1/4"
Average Air Consumption	: 4CFM
Recommended Hose Size	: 3/8" I.D.
Air Inlet	: 1/4" NPT
Maximum Air Pressure	: 90psi

AIR IMPACT SCREWDRIVER

1/4" DR. ALAT PEMBUKA SKRUP TENAGA ANGIN

ITEM CODE	SIZE	1 (mm)	2 (mm)	3 (mm)	4 (mm)	5 (mm)	6 (mm)	WEIGHT (gr)	QTY / BOX INNER/MASTER
AT-AS1302	1/4"	188	93	17	42	64.5	6	672	1 / 20 pcs



- Ergonomic design of the industrial air screwdriver highly reduce fatigues while deliver the best performance
- Equipped with screw head quick connector: 1/4" (6.35mm) ensures that bit won't drop accidentally, easy to operate
- Forward reverse switch controls the bit to move clockwise or anticlockwise, so people can install or remove the screw conveniently

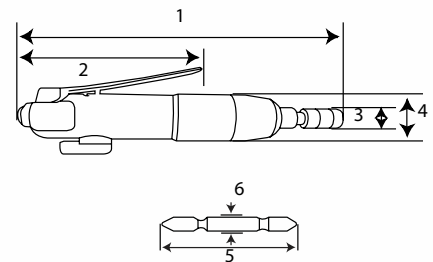

SPECIFICATION

Capacity	: 5/32"-33/16"
Free Speed	: 8000rpm
Max Torque	: 20-60in.lbs / 23-69kgs-cm
Air Inlet	: 1/4"
Air hose(ID)	: 3/8"
Average Air Consumption	: 6CFM
Working Pressure	: 90Psi/6.3bar
Hex Shank Size	: 1/4"

- Rubber grip handle more comfortable
- Simply to add stapler bullets

AIR STAPLER

ALAT TEMBAK STAPLES TENAGA ANGIN

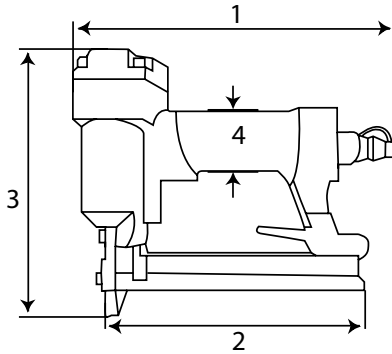

ITEM CODE	SIZE	1 (mm)	2 (mm)	3 (mm)	4 (mm)	WEIGHT (gr)	QTY / BOX INNER/MASTER
AT-AS1130	11.2x10-22mm	234	191	172	42	1,117	1 / 10 pcs



SPECIFICATION

Capacity	: 100 staples
Staple Size	: 20 gauge(1.20*0.60mm)
Staple Crown Size	: 0.44"(11.2mm)
Staple Lengths	: 13/32"to 7/8"(10 to 22mm)
Operating Pressure	: 60-110psi(4-7.5bar)
Max Pressure	: 120psi(8.3bar)
Air Consumption	: 0.9 SCFM@90psi
Air Inlet	: 1/4" NPT or BSP

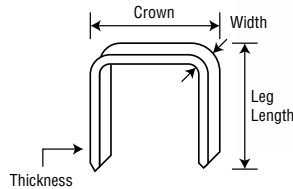

- Rubber grip handle more comfortable
- Simply to add nail bullets

AIR NAILER F30 C

ALAT TEMBAK PAKU TENAGA ANGIN F30C

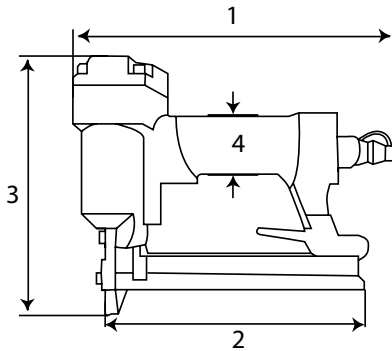

ITEM CODE	SIZE	1 (mm)	2 (mm)	3 (mm)	4 (mm)	WEIGHT (gr)	QTY / BOX INNER/MASTER
AT-AN1129	1.05 X 1.25 mm	233	206	183	42	1,030	1 / 10 pcs



SPECIFICATION

Capacity	: 100 nails
Nails Size	: 18 gauge(1.05*1.25mm)
Nails Lengths	: 3/8"to 1-3/16"(10 to 30mm)
Operating Pressure	: 60-110 Psi(4-7.5bar)
Max Pressure	: 120psi(8.3bar)
Air Consumption	: 0.9 SCFM@90 psi
Air Inlet	: 1/4" NPT or BSP

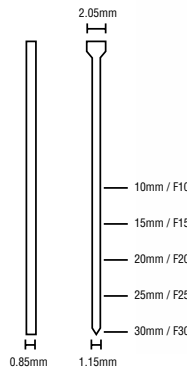

AIR RIVETER-1

ALAT TEMBAK RIVET TENAGA ANGIN

ITEM CODE	SIZE	1 (mm)	2 (mm)	3 (mm)	4 (mm)	WEIGHT (gr)	QTY / BOX INNER/MASTER
AT-AR1806	3/16"	262	165	78	119	1,600	1 / 10 pcs

SPECIFICATION

Traction Power	: 2680lbs (1219Kg)
Tool Stroke	: 0.552" (14mm)
Nose Pieces	: 2.4-3.2-4.0-4.8mm
AVG-AIR Consumption	: 3.5 CFM
Rivet Material	: Aluminum & Stainless
Work Capacity	: up to 5/32" (4mm) In All Material up to 3/16" (4.8mm) In AL. & Steel Blinds
Working Pressure	: 60 ~ 100psi
Air Inlet	: 1/4" PT (NPT)

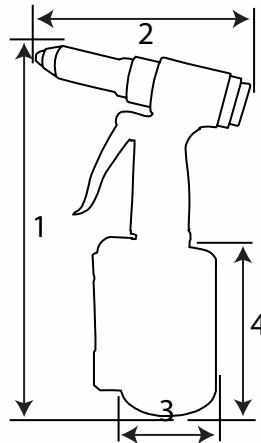

- Compact, lightweight cast aluminum body, ergonomic design for easy operation
- Powerful : 2.680 lbs of traction power to efficiently handle tough jobs

MICRO AIR DIE GRINDER KIT

MICRO GERINDA TENAGA ANGIN SET 16 PCS

ITEM CODE	CONTENT	WEIGHT (gr)	QTY / BOX INNER/MASTER
AT-AG1132	1 pcs Micro Die Grinder	690	1 / 20 set
	1 pcs Mini Oiler		
	1 pcs Oil Pot		
	2 pcs Hand Wrenches		
	1 pcs Female Nipple		
	10 pcs Mounted Stones		

- General industrial application air micro grinder, especially for industrial moulding
- Versatile kit for all types of applications
- 1/4" collets design with 60.000 Rpm



AUTOMOTIVE

STORAGE

TRAY

AIR TOOLS

HEX KEY

GENERAL TOOLS



AIR SPRAY GUN

TEKIRO air gun adopted H.V.L.P technology

The high volume and low-pressure atomization technology is adapted to have a fine atomizing effect, thus achieving an optimal combination of quality and efficiency: 10%-30% paint can be saved as compared with a common spray gun)



Aluminum 400 ml

H.V.L.P Air Cap Set



Optimal Pressure :
4 Bar / 57 Psi



Precision Trigger



Ergonomic Handle

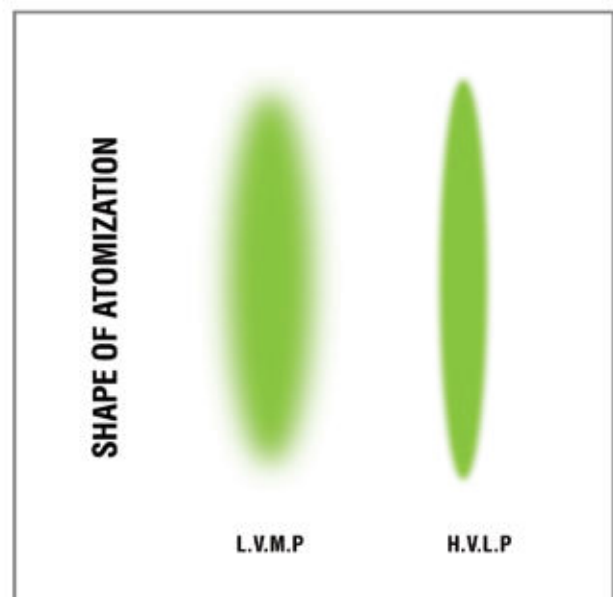
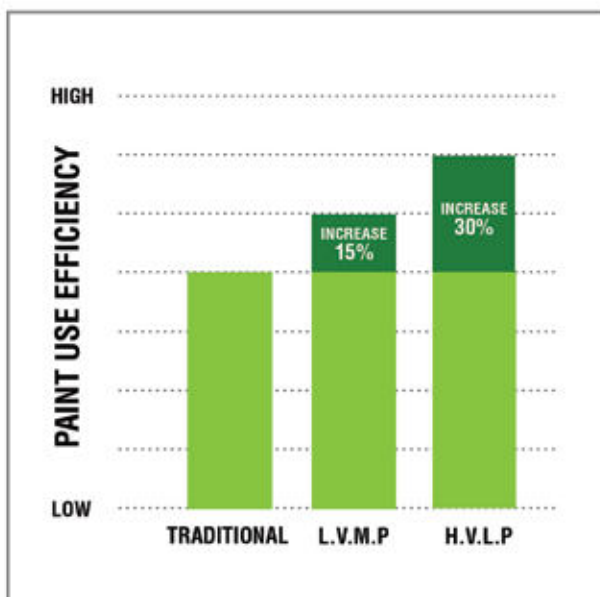

AIR SPRAY GUN

SEMPROTAN CAT TABUNG ATAS

ITEM CODE	SIZE	1 (mm)	2 (mm)	3 (mm)	4 (mm)	WEIGHT (gr)	QTY / BOX INNER/MASTER
AT-AS1616	F75 G	149	29	27	150	750	1 / 20 pcs
AT-AS1618	F100 G	87	90	130	172	847	1 / 20 pcs

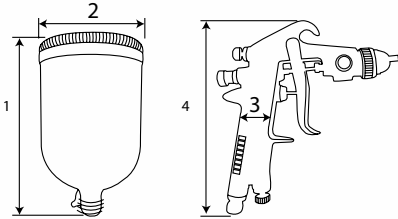

SPECIFICATION

	AT-AS1616	AT-AS1618
Optimal Working Pressure	4.0 bar / 57psi	4.0bar / 57psi
Pattern Width	About 200mm	About 240mm
Air Consumption	2-3cfm	2.5-3.5cfm
Capacity of Cup	Aluminum 400ml	Aluminum 400ml
Air Inlet	1/4" (bsp/npt/nps)	1/4" (bsp/npt/nps)
Nozzle Size	1.5 mm	1.5 mm



- Made by special steel
- Removable nozzle
- Perfect pulverization
- Stable spraying shape

AIR SPRAY GUN

SEMPROTAN CAT TABUNG BAWAH

ITEM CODE	SIZE	1 (mm)	2 (mm)	3 (mm)	4 (mm)	5 (mm)	WEIGHT (gr)	QTY / BOX INNER/MASTER
AT-AS1617	F75 S	120	119	874	15	173	750	1 / 20 pcs
AT-AS1619	F100 S	87	90	84	15	172	847	1 / 20 pcs

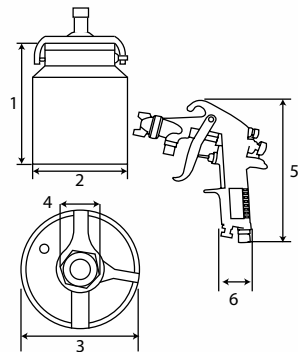

SPECIFICATION

	AT-AS1617	AT-AS1619
Optimal Working Pressure	4.0bar / 57psi	4.0 bar / 5 psi
Pattern Width	About 200mm	About 240mm
Air Consumption	2-3cfm	2.5-3.5cfm
Capacity of Cup	Aluminum 750ml	Aluminum 600ml
Air Inlet	1/4" (bsp/npt/nps)	1/4" (bsp/npt/nps)
Nozzle Size	1.5 mm	1.5 mm



- Made by special steel
- Removable nozzle
- Perfect pulverization
- Stable spraying shape

AIR SPRAY GUN K-3

SEMPROTAN CAT TABUNG ATAS K-3

ITEM CODE	SIZE	1 (mm)	2 (mm)	3 (mm)	4 (mm)	WEIGHT (gr)	QTY / BOX INNER/MASTER
AT-AS1620	K-3	55	105	145	28	378	1 / 30 pcs

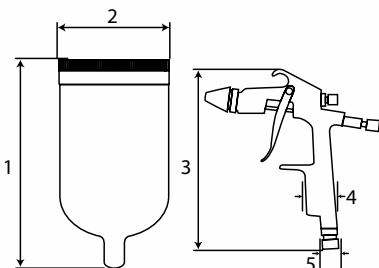

SPECIFICATION

	AT-AS1620
Optimal Working Pressure	2.5bar / 36psi
Pattern Width	About 50mm
Air Consumption	1-2cfm
Capacity of Cup	Aluminum 200ml
Air Inlet	1/4" (bsp/npt/nps)
Nozzle Size	0.5 mm



- Made by special steel
- Removable nozzle
- Perfect pulverization
- Stable spraying shape



- Made by special steel
- Removable nozzle
- Perfect pulverization
- Stable spraying shape

AIR SPRAY GUN 472B

SEMPROTAN CAT TABUNG BAWAH 472B

ITEM CODE	SIZE	1 (mm)	2 (mm)	3 (mm)	4 (mm)	5 (mm)	WEIGHT (gr)	QTY / BOX INNER/MASTER
AT-AS1720	472 B	135	100	65	100	60	700	1 / 10 pcs



SPECIFICATION

	AT-AS1720
Optimal Working Pressure	4.0bar / 57psi
Pattern Width	About 250mm
Air Consumption	3.5-6.0cfm
Capacity of Cup	Aluminum 750ml
Air Inlet	1/4" (bsp/npt/nps)
Nozzle Size	1.5 mm

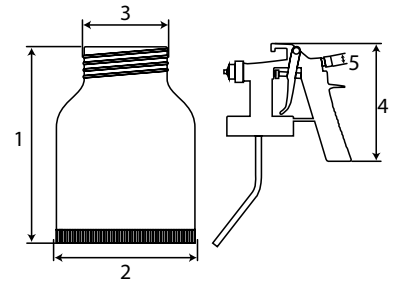

- Made by special steel
- Perfect pulverization
- Stable spraying shape

AIR SPRAY GUN K3A

SEMPROTAN CAT TABUNG ATAS K3A

ITEM CODE	SIZE	1 (mm)	2 (mm)	3 (mm)	4 (mm)	5 (mm)	WEIGHT (gr)	QTY / BOX INNER/MASTER
AT-AS1868	K3A	150	28	13	115	55	300	1 / 30 pcs



SPECIFICATION

	AT-AS1868
Optimal Working Pressure	2.0bar / 29psi
Pattern Width	About 140mm
Air Consumption	2-3cfm
Capacity of Cup	Aluminum 125ml
Air Inlet	1/4" (bsp/npt/nps)
Nozzle Size	0.5 mm

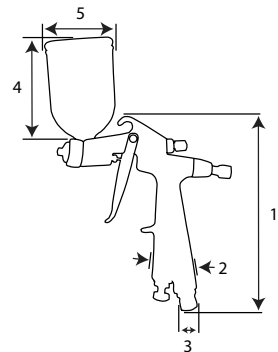

- Made by special steel
- Removable nozzle
- Perfect pulverization
- Stable spraying shape
- Include regulator

AIR SPRAY GUN K350 KIT

SEMPROTAN CAT TABUNG ATAS K350 KIT

ITEM CODE	SIZE	1 (mm)	2 (mm)	3 (mm)	4 (mm)	5 (mm)	6 (mm)	WEIGHT (gr)	QTY / BOX INNER/MASTER
AT-AS1869	K350 KIT	168	29	13	88	53	41	500	1 / 20 pcs



SPECIFICATION

	AT-AS1869
Optimal Working Pressure	2.0bar / 29psi
Pattern Width	About 100mm
Air Consumption	5-5.5cfm
Capacity of Cup	Aluminum 125ml
Air Inlet	1/4" (bsp/npt/nps)
Nozzle Size	0.5 mm

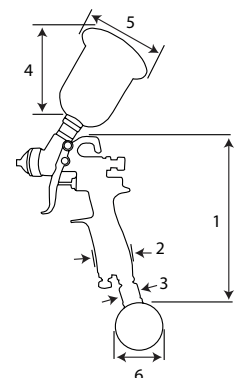

AIR CONTROL UNIT

TEKIRO CONTROL UNIT have Full control over operating air pressure is provided by locking the airflow adjustment knob. **Water Moisture Trap Filter:** Removes solid particles and condensation associated with compressed air. Provides you clean, dry air which prevents damage to air tools and pneumatic equipment. Has an easy release drain valve. **Micro-Fog Lubricator:** Supplies lubricating oil to pneumatic equipment in the proper proportions of oil to air consumption

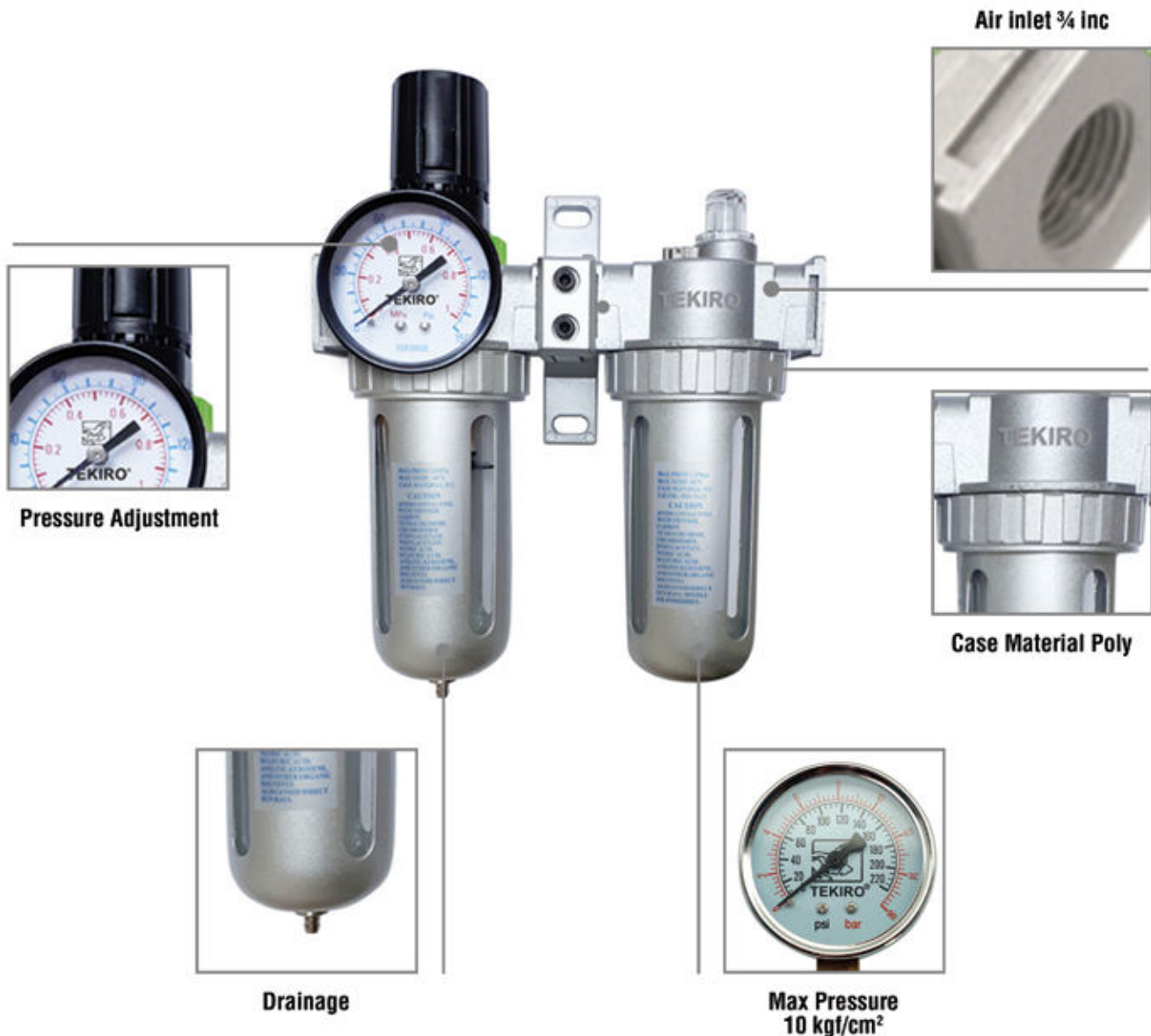

SAFETY INSTRUCTION

- Please clean the port and fitting before installation, it will effectively avoid bring dust to the air path.
- Pay attention to the direction of airflow and an arrow pointing on product body if correct, minding port and thread size if match.
- Pull up the knob of pressure gauge, rotate:
 - Clockwise rotation, the pressure will rise steadily.
 - Counterclockwise, the pressure will down
 - Stop turning after reaching the required index and lock down the knob, forget this step you may face leakage problem
- Rotate the needle valve in the "+" direction to increase the oil absorption speed, and it will slow down or stop when you rotate to "-" direction.

AIR CONTROL UNIT SINGLE

SARINGAN UDARA 1 TABUNG



ITEM CODE	SIZE	1 (mm)	2 (mm)	3 (mm)	4 (mm)	5 (mm)	AIR INLET (inch)	WEIGHT (gr)	QTY / BOX INNER/MASTER
AT-AC1702	3/4"	214	47	30	40	50	3/4	634	1 / 20 pcs

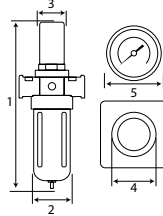

- Case material poly carbonate
- High pressure (Maximum Pressure 10Kgf/cm²)
- High temperature (5-60°C or 40-140°F)
- Easy for installation
- Suitable for Limited Space Application
- Drain Release Automatically When Water Accumulation is less than 1 KG

AIR CONTROL UNIT DOUBLE

SARINGAN UDARA 2 TABUNG



ITEM CODE	SIZE	1 (mm)	2 (mm)	3 (mm)	4 (mm)	5 (mm)	AIR INLET (inch)	WEIGHT (gr)	QTY / BOX INNER/MASTER
AT-AC1703	3/4"	214	49	32	170	50	3/4	1,040	1 / 10 pcs

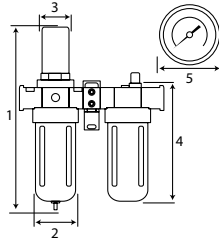

- Case material poly carbonate
- High pressure (Maximum Pressure 10Kgf/cm²)
- High temperature (5-60°C or 40-140°F)
- Easy for installation
- Suitable for Limited Space Application
- Drain Release Automatically When Water Accumulation is less than 1KG

MINI AIR CONTROL UNIT SINGLE

SARINGAN UDARA 1 TABUNG MINI



ITEM CODE	SIZE	1 (mm)	2 (mm)	3 (mm)	4 (mm)	5 (mm)	AIR INLET (inch)	WEIGHT (gr)	QTY / BOX INNER/MASTER
AT-AC1704	1/4"	150	30	26	29	40	1/4	264	1 / 50 pcs

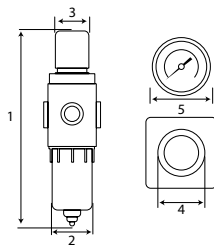

- Case material poly carbonate
- High pressure (Maximum Pressure 10Kgf/cm²)
- High temperature (5-60°C or 40-140°F)
- Easy for installation
- Suitable for Limited Space Application
- Drain Release Automatically When Water Accumulation is less than 1KG

MINI AIR CONTROL UNIT DOUBLE

SARINGAN UDARA 2 TABUNG MINI



ITEM CODE	SIZE	1 (mm)	2 (mm)	3 (mm)	4 (mm)	5 (mm)	AIR INLET (inch)	WEIGHT (gr)	QTY / BOX INNER/MASTER
AT-AC1705	1/4"	148	30	25	128	40	1/4	365	1 / 50 pcs

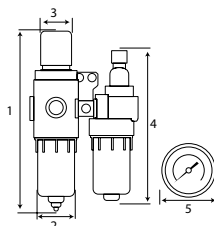

- Case material poly carbonate
- High pressure (Maximum Pressure 10Kgf/cm²)
- High temperature (5-60°C or 40-140°F)
- Easy for installation
- Suitable for Limited Space Application
- Drain Release Automatically When Water Accumulation is less than 1KG

AIR TOOLS AIR IMPACT WRENCH

Designed and engineered to work hard, our air impact wrenches handle the toughest jobs, offering outstanding value. Industrial professionals will be able to release wheel nuts quickly and easily with our versatile impact wrenches; our impact wrenches are feature-packed, giving you the power and torque you need to easily do your job.



TEKIRO AIR IMPACT WRENCH

Built to deliver outstanding performance in any job. With several product lines and a range of different potential configurations, it's easy to find the right tool for the task. All our products feature an industry-leading combination of performance, ergonomics and durability — everything you need to boost production and keep your team working more efficiently all-day long.

GO TOUGH AND RUGGED

Designed to withstand tough use in rugged environments, this impact wrench offers greater

DIFFERENT SPEED SETTINGS

Available in multiple speeds for each forward and reverse direction, our impact wrench range offers torque outputs to 650 n/m. Alloy steel, heat treated, helical gears for maximum durability.

AIR TOOLS TEKIRO ALL AIR IMPACT TECHNOLOGY

AIR IMPACT

- Comfort over long periods of use
Twin clutch with high
- Performance clutch - longer life under tough condition
- Ergonomic handle exhaust keeps exhaust air away from the operator



PIN CLUTCH HAMMER MECHANISM

- Two Pin Clutch hammers strike the anvil, provides high torque, low vibration and fast run downs.
- The mechanism delivers higher performance and extended durability
- For automotive service work and better for assembly lines



AIR IMPACT WRENCH JUMBO HAMMER

- High torque air impact
- Comfort over long periods of use
- Performance clutch - longer life under tough condition
- Ergonomic handle exhaust keeps exhaust air away from the operator
- High Speed 10.000 Rpm



JUMBO HAMMER MECHANISM

- Same mechanism as Twin Hammer but with one hammer only. It delivers an instantaneous, balanced blow, with excellent impacting power



**AIR TOOLS
TEKIRO ALL AIR IMPACT TECHNOLOGY**

ANVIL AIR IMPACT

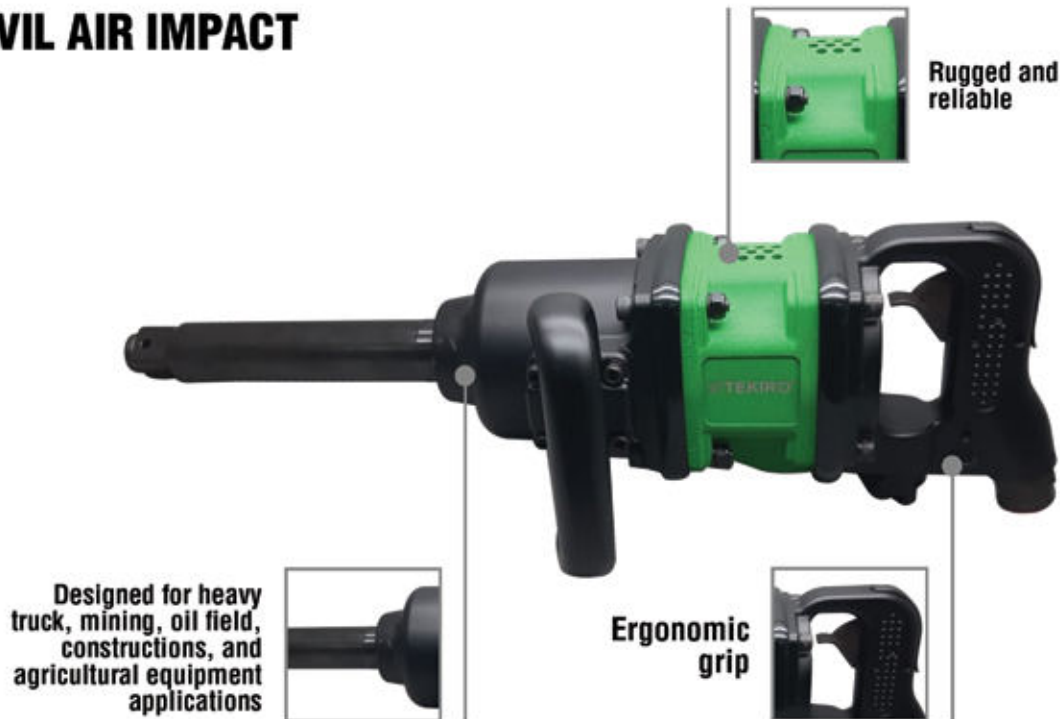

ANVIL TWIN HAMMER

- High torque air impact
- Comfort over long periods of use
- Performance clutch - longer life under tough condition
- Ergonomic handle exhaust keeps exhaust air away from the operator
- High Speed 8.000 Rpm
- Two hammers make one impact per rotation.
- This design is the most durable of hammer designs and lighter, less vibration, producing a powerful impact



TWIN HAMMER MECHANISM

- High torque when starting with good continuity
- Endurable impact with consistent torque for long time work
- Constructed with precision components and impact mechanism
- One cycle, two hammers
- More powerful than any other mechanism on the market



AUTOMOTIVE

STORAGE

TRAY

AIR TOOLS

HEX KEY

GENERAL TOOLS

- 370 - 800 Ft. Lbs. of Torque - power to loosen the toughest fastener
- Comfort over long periods of use
- Twin clutch with high performance clutch - longer life under tough conditions
- Ergonomic handle exhaust keeps exhaust air away from the operator

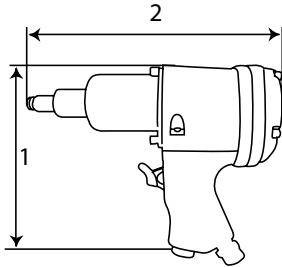

- High Specification Torque
- Handle Exhaust
- Not slippery when used
- Strength and Precision Drive

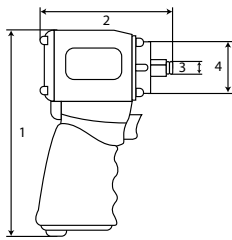

HEAVY DUTY IMPACT WRENCH

ALAT PEMBUKA BAUT TENAGA ANGIN

SPEC	1/2"	3/4"
ITEM CODE	AT-AI1126	AT-AI1127
SPEED (RPM)	7000	4700
BOLT CAPACITY	3/4"	1"
SQUARE DRIVER	1/2"	3/4"
MAX TORQUE (LBS)	370	800
AIR PRESS. (Psi)	90	90
AIR INLET (NPT)	1/4"	1/4"
HOSE SIZE (ID)	3/8"	3/8"
AIR CONS. (CFM)	4	5
OVERALL LENGTH	7 9/16"	9 3/4"
QTY / BOX (INNER / MASTER)	1 / 10 pcs	1 / 4 pcs
1 (mm)	189	231
2 (mm)	197	246
WEIGHT (gr)	2,600	4,910

1/2" AIR IMPACT WRENCH JUMBO HAMMER

1/2" DR. ALAT PEMBUKA BAUT TENAGA ANGIN JUMBO HAMMER

SPEC	1/2"
ITEM CODE	AT-AI1668
SPEED (RPM)	10,000
BOLT CAPACITY	M16 (24mm)
SQUARE DRIVER	1/2"
MAX TORQUE (Nm)	678
AIR CONS. (m ³ /min)	0.22
AIR INLET (NPT)	1/4"
HOSE SIZE (mm)	10mm
SOUND PRESSURE (dBA)	94
VIBRATION (m/s ²)	2.8
QTY / BOX (INNER / MASTER)	1 / 10 pcs
1 (mm)	190
2 (mm)	99
3 (mm)	13
4 (mm)	51
WEIGHT (gr)	1,520

1/2" AIR IMPACT WRENCH TWIN HAMMER

1/2" DR. ALAT PEMBUKA BAUT TENAGA ANGIN TWIN HAMMER

SPEC	1/2"
ITEM CODE	AT-AI1669
SPEED (RPM)	8,000
BOLT CAPACITY	M18 (27mm)
SQUARE DRIVER	1/2"
MAX TORQUE (Nm)	610
AIR CONS. (m ³ /min)	0.22
AIR INLET (NPT)	1/4"
HOSE SIZE (mm)	10 mm
SOUND PRESSURE (dBA)	98
VIBRATION (m/s ²)	4.6
QTY / BOX (INNER / MASTER)	1 / 6 pcs
1 (mm)	185
2 (mm)	189
3 (mm)	12
4 (mm)	62
WEIGHT (gr)	2,910

- High Specification Torque
- Front Exhaust
- Not slippery when used
- Strength and Precision Drive

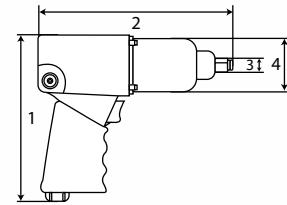

3/4" AIR IMPACT WRENCH TWIN HAMMER

3/4" DR. ALAT PEMBUKA BAUT TENAGA ANGIN TWIN HAMMER

SPEC	3/4"
ITEM CODE	AT-AI1727
SPEED (RPM)	6,000
BOLT CAPACITY	36mm
SQUARE DRIVER	3/4"
MAX TORQUE (Nm)	1,491
AIR CONS. (m ³ /min)	0.32
AIR INLET (NPT)	1/4"
HOSE SIZE (mm)	10 mm
SOUND PRESSURE (dBA)	94
VIBRATION (m/s ²)	5.3
QTY / BOX (INNER / MASTER)	1 / 4 pcs
1 (mm)	205
2 (mm)	205
3 (mm)	18
4 (mm)	69
WEIGHT (gr)	4,200

- High Specification Torque
- Front Exhaust
- Not slippery when used
- Strength and Precision Drive

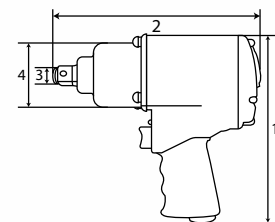

- High Specification Torque
- Front Exhaust
- Not slippery when used
- Strength and Precision Drive

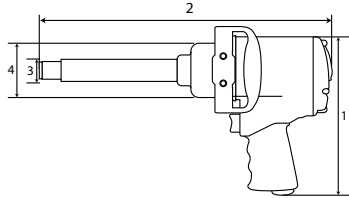

- High Specification Torque
- Front Exhaust
- Not slippery when used
- Strength and Precision Drive

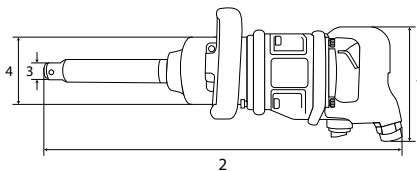

1" AIR IMPACT WRENCH TWIN HAMMER

1" DR. ALAT PEMBUKA BAUT TENAGA ANGIN TWIN HAMMER

SPEC	1"
ITEM CODE	AT-AI1728
SPEED (RPM)	4500
BOLT CAPACITY	38 mm
SQUARE DRIVER	1"
MAX TORQUE (Nm)	2,440
AIR CONS. (m ³ /min)	0.32
AIR INLET (NPT)	3/8"
HOSE SIZE (mm)	10 mm
SOUND PRESSURE (dBA)	97
VIBRATION (m/s ²)	6.1
QTY / BOX (INNER / MASTER)	1 / 2 pcs
1 (mm)	225
2 (mm)	400
3 (mm)	25
4 (mm)	85
WEIGHT (gr)	6,700

1" AIR IMPACT WRENCH ANVIL TWIN HAMMER

1" DR. ALAT PEMBUKA BAUT TENAGA ANGIN ANVIL TWIN HAMMER

SPEC	1"
ITEM CODE	AT-AI1897
SPEED (RPM)	3,600
BOLT CAPACITY	M42 (65mm)
SQUARE DRIVER	1"
MAX TORQUE (Nm)	2,200 ft-lb @15Sec 2,982 Nm @15Sec
AIR CONS. (m ³ /min)	0.31
AIR INLET (NPT)	1/2"
HOSE SIZE (inch)	1/2"
SOUND PRESSURE (dBA)	101.5
VIBRATION (m/s ²)	
QTY / BOX (INNER / MASTER)	1 / 2 pcs
1 (mm)	172
2 (mm)	580
3 (mm)	25
4 (mm)	105
WEIGHT (gr)	15,000

Note: Tekiro's warranty applied for Indonesia market only

AIR IMPACT TWIN HAMMER 1/2" 12 PC

1/2" DR. ALAT PEMBUKA BAUT TENAGA ANGIN SET 12 PCS TWIN HAMMER

- High Specification Torque 450 ft. lbs
- Front Exhaust
- Twin Hammer mechanism

ITEM CODE	CONTENT	WEIGHT (gr)	QTY / BOX INNER/MASTER
AT-AI1733	1/2" Air Impact Wrench Twin Hammer	5,685	1 / 4 set
	1/2" DR. Deep Impact Socket 6PT 10 mm		
	1/2" DR. Deep Impact Socket 6PT 12 mm		
	1/2" DR. Deep Impact Socket 6PT 14 mm		
	1/2" DR. Deep Impact Socket 6PT 17 mm		
	1/2" DR. Deep Impact Socket 6PT 19 mm		
	1/2" DR. Deep Impact Socket 6PT 21 mm		
	1/2" DR. Deep Impact Socket 6PT 23 mm		
	1/2" DR. Deep Impact Socket 6PT 24 mm		
	Mini Oiler		
	Oil Pot		
	Coupler		



AIR IMPACT JUMBO WITH STUBBY IMPACT SOCKET SET 12 PCS

1/2" DR. ALAT PEMBUKA BAUT TENAGA ANGIN SET 12 PCS JUMBO

- High Specification Torque 500 ft. lbs
- Handle Exhaust
- Jumbo Hammer mechanism

ITEM CODE	CONTENT	WEIGHT (gr)	QTY / BOX INNER/MASTER
AT-AI1750	Impact Socket 1/2" 6 PT	1,596	1 / 6 set
	Coupler		
	Air Filter		
	Mini Oiler		



AUTOMOTIVE

STORAGE

TRAY

AIR TOOLS

HEX KEY

GENERAL TOOLS

- High Torque
- Right and left switch
- Side exhaust
- Durable aluminum housing

AIR RATCHET WRENCH

KUNCI RATCHET TENAGA ANGIN



ITEM CODE	SIZE	1 (mm)	2 (mm)	3 (mm)	4 (mm)	5 (mm)	WEIGHT (gr)	QTY / BOX INNER/MASTER
AT-AR1797	3/8"	263	25	8	19	26	1,170	1 / 20 pcs
AT-AR1798	1/2"	263	25	12	19	27	1,170	1 / 20 pcs

SPECIFICATION	SIZE	
	3/8"	1/2"
Square Driver	3/8"	1/2"
Free Speed	150RPM	150RPM
Max. Torque	50ft-lbs	50ft-lbs
Air Inlet	1/4"	1/4"
Air Pressure	90psi	90psi
Air Consumption	4CFM	4CFM

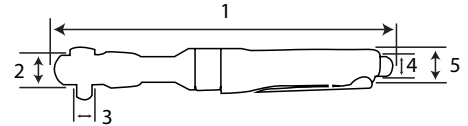

- High quality Plastic
- High purity filter
- Aluminum cover for extra strength

OIL AIR FILTER 1/4"

1/4" SARINGAN UDARA



ITEM CODE	SIZE	1 (mm)	2 (mm)	3 (mm)	4 (mm)	WEIGHT (gr)	QTY / BOX INNER/MASTER
AT-OA1870	1/4"	86.5	13	39	11.5	1,100	10 / 100 pcs

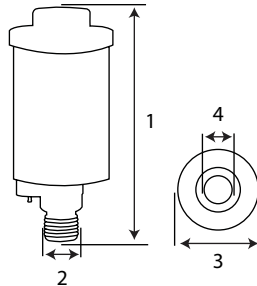

- Low vibration for swirlmark-free finishes
- Durable, Lightweight composite housing design
- Low profile balanced sanding pad

NON-VACUUM ORBITAL SANDER

ALAT AMPLAS TENAGA ANGIN

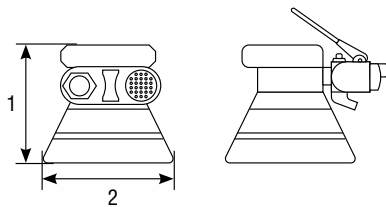

SPEC	AT-OS1873	AT-OS1874
ITEM CODE	AT-OS1873	AT-OS1874
SPEC (Diameter Pad)	5"	6"
SPEED (RPM)	11,000	11,000
Diameter Orbit (mm)	5	5
Noise Level (dBA)	80	80
Vibration (m/s ²)	0.8	0.8
Air Inlet (Inch)	1/4	1/4
Min. Hose Size (Inch / mm)	3/8 (10)	3/8 (10)
Average Air Consumption (CFM)	1.6	1.6
1 (mm)	122	148
2 (mm)	93	94
WEIGHT (gr)	780	810
Qty / Box Inner / Master	1 / 10	1 / 10

HEX KEY





HEX KEYS

TEKIRO engineered Hex Keys comes in individual and sets. Hex, Ball point and Torx heads are perfectly suited for typical repair and maintenance jobs.

Manufactured from high quality material Tekiro hex keys exceeds both ANSI and JIS standards

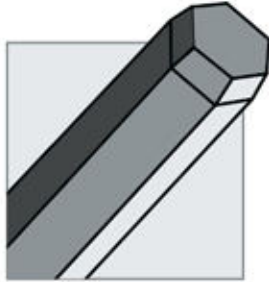

HEX HEAD

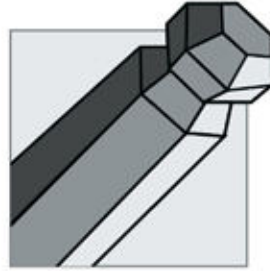

BALL POINT HEAD



TORX HEAD



Ball End
up to 25°
work angles



High Quality
Material with
Head Treatment

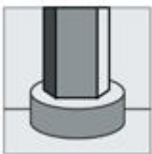

Slot Machined
High precision



Quick Plug



Permanent Marking
Easy identification
on the key body



T SHAPE HEX

Manufactured with high-strength and durable material. The grip is ergonomically designed to ease gripping, handling and improving torque performance. Routed tip finish for better gripping and holding of screws. The hex key are chrome plated to prevent oxidation and rust.

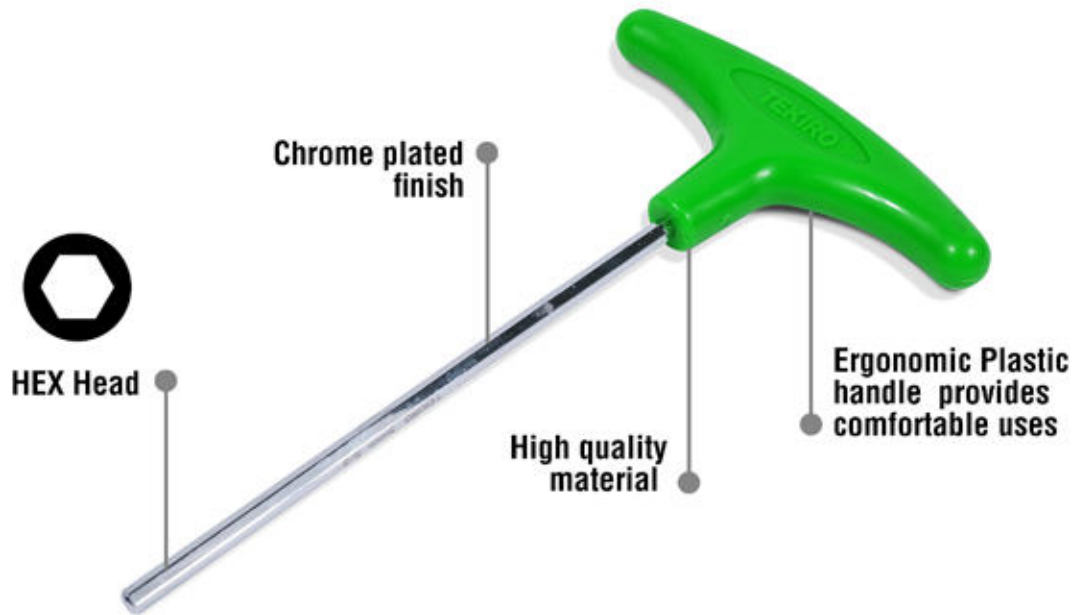

BALLPOINT HEX KEY LONG SET 9 PCS

TEKIRO BALLPOINT HEX KEY LONG SET 9 PCS includes 1.5, 2, 2.5, 3, 4, 5, 6, 8, 10 mm precision hex keys. Ball end design allows up to a 25-degree angle of entry for faster insertion and removal of screws. **TEKIRO BALLPOINT HEX KEY** are constructed of durable, high-quality material. The long design provides more torque and greater reach. Sizes are laser etched onto keys for quick and easy identification. Set also includes a plastic organizer with size markings.



HOLDER HEX KEY
All keys are labeled by size and stored conveniently in the compact rack



PERMANENT MARKING
Easy identification on the key body



BALL TIP
Allows access and removal of bits normally unreachable by a standard hex key.

- S2 material with proper heat treatment for extra durability and strength
- Chrome plated finish for extra rust resistance

HEX KEY SHORT

KUNCI L PENDEK

METRIC

ITEM CODE	SIZE	1 (mm)	2 (mm)	3 (mm)	WEIGHT (gr)	QTY / BOX INNER/MASTER
HK-SH1133	1.5 mm	46	15	2	1	100 / 600 pcs
HK-SH1134	2 mm	50	15	2	2	100 / 600 pcs
HK-SH1135	2.5 mm	56	19	3	3	100 / 1000 pcs
HK-SH1136	3 mm	63	22	3	5	100 / 600 pcs
HK-SH1137	3.5 mm	70	25	4	6	100 / 1000 pcs
HK-SH1138	4 mm	72	26	4	10	100 / 1200 pcs
HK-SH1139	4.5 mm	79	30	5	13	100 / 1200 pcs
HK-SH1140	5 mm	82	32	5	18	100 / 1200 pcs
HK-SH1141	5.5 mm	90	35	6	23	50 / 1200 pcs
HK-SH1142	6 mm	94	37	6	29	100 / 600 pcs
HK-SH1143	6.5 mm	110	41	7	38	100 / 600 pcs
HK-SH1144	8 mm	104	43	8	57	50 / 300 pcs
HK-SH1145	10 mm	118	49	10	100	25 / 150 pcs
HK-SH1146	12 mm	132	54	12	150	25 / 150 pcs
HK-SH1147	14 mm	150	68	14	250	20 / 120 pcs
HK-SH1148	17 mm	183	81	17	440	10 / 60 pcs
HK-SH1149	19 mm	210	87	19	625	4 / 40 pcs

INCH

ITEM CODE	SIZE	1 (mm)	2 (mm)	3 (mm)	WEIGHT (gr)	QTY / BOX INNER/MASTER
HK-SH1150	1/16"	46	15	1	1	100 / 600 pcs
HK-SH1151	5/64"	51	17	2	2	100 / 600 pcs
HK-SH1152	3/32"	58	20	2	3	100 / 600 pcs
HK-SH1153	1/8"	66	23	2	5	100 / 600 pcs
HK-SH1154	9/64"	67	24	3	7	100 / 1000 pcs
HK-SH1155	5/32"	74	27	4	9	100 / 1000 pcs
HK-SH1156	3/16"	82	31	4	16	10 / 1000 pcs
HK-SH1157	7/32"	92	33	5	24	10 / 1000 pcs
HK-SH1158	1/4"	96	37	6	33	100 / 600 pcs
HK-SH1159	5/16"	104	42	8	58	50 / 300 pcs
HK-SH1160	3/8"	108	48	9	91	25 / 150 pcs
HK-SH1396	15/32"	136	57	11	163	25 / 150 pcs
HK-SH1161	1/2"	137	55	11	186	25 / 150 pcs
HK-SH1162	9/16"	156	69	16	271	20 / 120 pcs
HK-SH1397	21/32"	178	79	12	429	10 / 60 pcs
HK-SH1163	3/4"	199	87	19	615	10 / 40 pcs

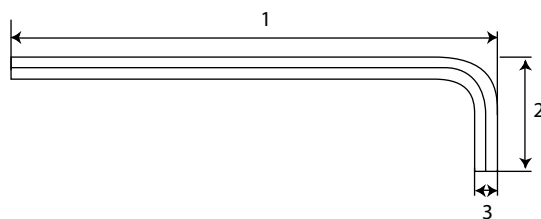

HEX KEY LONG

KUNCI L PANJANG

- S2 material with proper heat treatment for extra durability and strength
- Chrome plated finish for extra rust resistance

METRIC

ITEM CODE	SIZE	1 (mm)	2 (mm)	3 (mm)	WEIGHT (gr)	QTY / BOX INNER/MASTER
HK-LO1164	1.5 mm	90	14	2	2	50 / 1500 pcs
HK-LO1165	2 mm	100	17	2	3	50 / 1500 pcs
HK-LO1166	2.5 mm	113	20	3	6	50 / 1500 pcs
HK-LO1167	3 mm	127	22	3	8	50 / 1500 pcs
HK-LO1168	4 mm	142	29	4	17	50 / 1000 pcs
HK-LO1169	5 mm	162	32	5	31	50 / 600 pcs
HK-LO1170	6 mm	183	37	6	50	50 / 450 pcs
HK-LO1171	8 mm	204	43	8	99	25 / 150 pcs
HK-LO1172	10 mm	232	48	10	176	25 / 150 pcs
HK-LO1173	12 mm	255	53	12	280	10 / 60 pcs
HK-LO1174	14 mm	290	70	14	430	10 / 60 pcs
HK-LO1175	17 mm	330	79	17	740	5 / 30 pcs
HK-LO1176	19 mm	380	89	19	1,050	5 / 30 pcs

INCH

ITEM CODE	SIZE	1 (mm)	2 (mm)	3 (mm)	WEIGHT (gr)	QTY / BOX INNER/MASTER
HK-LO1177	1/16"	90	14	1	2	50 / 1000 pcs
HK-LO1178	5/64"	102	18	2	3	50 / 1000 pcs
HK-LO1179	3/32"	105	20	2	4	50 / 1000 pcs
HK-LO1180	1/8"	121	21	3	10	50 / 500 pcs
HK-LO1181	9/64"	135	25	3	12	50 / 500 pcs
HK-LO1182	5/32"	141	27	4	17	50 / 500 pcs
HK-LO1183	3/16"	162	31	4	28	50 / 500 pcs
HK-LO1184	7/32"	179	34	5	42	50 / 500 pcs
HK-LO1185	1/4"	183	36	6	54	50 / 300 pcs
HK-LO1186	5/16"	205	41	8	100	25 / 150 pcs
HK-LO1187	3/8"	233	48	8	150	25 / 150 pcs
HK-LO1398	15/32"	258	55	13	280	10 / 60 pcs
HK-LO1188	1/2"	256	57	12	310	10 / 60 pcs
HK-LO1189	9/16"	290	69	14	430	10 / 60 pcs
HK-LO1399	21/32"	333	80	12	431	5 / 30 pcs
HK-LO1190	3/4"	380	87	18	1,050	5 / 30 pcs

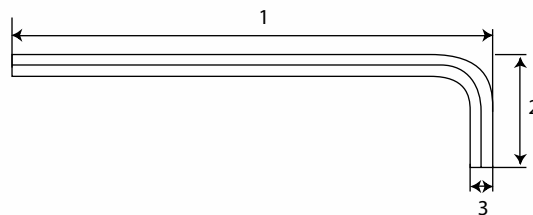

AUTOMOTIVE

STORAGE

TRAY

AIR TOOLS

HEX KEY

GENERAL TOOLS

- S2 material with proper heat treatment for extra durability and strength
- Chrome plated finish for extra rust resistance
- Ergonomic Plastic handle provides comfortable grip

T SHAPE HEX

KUNCI L TIPE T

ITEM CODE	SIZE	1 (mm)	2 (mm)	3 (mm)	4 (mm)	WEIGHT (gr)	QTY / BOX INNER/MASTER
HK-TS1191	T 2.5	161	109	97	3	28	10 / 100 pcs
HK-TS1192	T 3	176	125	97	3	33	10 / 100 pcs
HK-TS1193	T 4	181	130	97	4	41	10 / 100 pcs
HK-TS1194	T 5	208	148	100	5	73	10 / 100 pcs
HK-TS1195	T 6	230	170	122	6	94	10 / 100 pcs
HK-TS1196	T 8	261	200	123	8	151	10 / 80 pcs
HK-TS1197	T 10	278	200	160	10	274	10 / 40 pcs

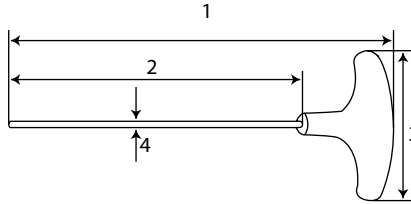

HOLDER case opens flat, making it easier to get wrenches in and out; high visibility sizes marked on the case for fast size selection & instant measurement identification

Each slot on the storage case provides a clear easy-to-read size marking (in either inches or mm), making it possible to quickly identify and locate the size needed.

- S2 material with proper heat treatment for extra durability and strength
- Convenient storage rack for hex keys and handle keeps this set together in your toolbox.
- Color-coded housing for instant identification of size Series

HEX KEY WRENCH SET 7 PCS

KUNCI L ELEKTRONIK MM SET 7 PCS

ITEM CODE	SIZE	CONTENT	WEIGHT (gr)	QTY / BOX INNER/MASTER
HK-EL1198	0.71- 3 mm	0.71mm, 0.89mm, 1.27mm, 1.5mm, 2mm, 2.5mm, 3mm	23	20 / 200 set
HK-EL1199	0.28"-7/64"	0.28, 0.35, 0.05, 1/16", 5/64", 3/32", 7/64"	22	20 / 200 set



HEX KEY SHORT SET 8 PCS

KUNCI L PENDEK MM SET 8 PCS

ITEM CODE	SIZE	CONTENT	WEIGHT (gr)	QTY / BOX INNER/MASTER
HK-SS1202	2 - 10 mm	2 mm, 2.5 mm, 3 mm, 4 mm, 5 mm, 6 mm, 8 mm, 10 mm	297	12 / 72 set

- S2 material with proper heat treatment for extra durability and strength
- Convenient storage rack for hex keys and handle keeps this set together in your toolbox
- Color-coded housing for instant identification of size Series



HEX KEY LONG SET 8 PCS

KUNCI L PANJANG MM SET 8 PCS

ITEM CODE	SIZE	CONTENT	WEIGHT (gr)	QTY / BOX INNER/MASTER
HK-LS1200	2 - 10 mm	2 mm, 2.5 mm, 3 mm, 4 mm, 5 mm, 6 mm, 8 mm, 10 mm	458	12 / 72 set
HK-LS1201	5/64" - 3/8"	5/64", 5/32", 3/16", 1/4", 5/16", 3/8"	444	12 / 72 set

- S2 material with proper heat treatment for extra durability and strength
- Convenient storage rack for hex keys and handle keeps this set together in your toolbox.
- Color-coded housing for instant identification of size Series



BALL POINT HEX KEY SET SHORT 9PCS

KUNCI L PENDEK BULAT SET 9 PCS

ITEM CODE	SIZE	CONTENT	WEIGHT (gr)	QTY / BOX INNER/MASTER
HK-BP1203	1.5 - 10 mm	1.5 mm, 2 mm, 2.5 mm, 3 mm, 4 mm, 5 mm, 6 mm, 8 mm, 10 mm	290	12 / 72 set

- S2 material with proper heat treatment for extra durability and strength
- Convenient storage rack for hex keys and handle keeps this set together in your toolbox
- Color-coded housing for instant identification of size Series
- Ball-end design allows entry angle of up to 25 degrees for easily reaching around obstructions



- S2 material with proper heat treatment for extra durability and strength
- Convenient storage rack for hex keys and handle keeps this set together in your toolbox.
- Color-coded housing for instant identification of size Series
- Ball-end design allows entry angle of up to 25 degrees for easily reaching around



BALL POINT HEX KEY SET LONG 9 PCS

KUNCI L PANJANG BULAT SET 9 PCS

ITEM CODE	SIZE	CONTENT	WEIGHT (gr)	QTY / BOX INNER/MASTER
HK-BP1204	1.5 - 10 mm	1.5 mm, 2 mm, 2.5 mm, 3 mm, 4 mm, 5 mm, 6 mm, 8 mm, 10 mm	447	6 / 48 set

- S2 material with proper heat treatment for extra durability and strength
- Convenient storage rack for hex keys and handle keeps this set together in your toolbox.
- Color-coded housing for instant identification of size Series
- Extra Long type with Precision chamfered ends - for working easy



TORX SET 9 PCS

KUNCI L BINTANG PANJANG SET 9 PCS

ITEM CODE	SIZE	CONTENT	WEIGHT (gr)	QTY / BOX INNER/MASTER
HK-T01205	T10 - T50	T10, T15, T20, T25, T27, T30, T40, T45, T50	450	12 / 48 set

Without center hole



- S2 material with proper heat treatment for extra durability and strength
- Convenient storage rack for hex keys and handle keeps this set together in your toolbox.
- Color-coded housing for instant identification of size Series
- Extra Long type with Precision chamfered ends - for working easy

TAMPER TORX SET 9 PCS

KUNCI L BINTANG PANJANG LUBANG SET 9 PCS

ITEM CODE	SIZE	CONTENT	WEIGHT (gr)	QTY / BOX INNER/MASTER
HK-TA1206	T10 - T50	T10, T15, T20, T25, T27, T30, T40, T45, T50	450	12 / 48 set

With center hole



HEX KEY STUBBY SET 9 PCS

KUNCI L STUBBY SET 9 PCS

ITEM CODE	SIZE	CONTENT	WEIGHT (gr)	QTY / BOX INNER/MASTER
HK-ST1210	1.5 -10	1.5 mm, 2 mm, 2.5 mm, 3 mm, 4 mm, 5 mm, 6 mm, 8 mm, 10 mm	502	6 / 36 set

- S2 material with proper heat treatment for extra durability and strength
- Convenient storage rack for hex keys and handle keeps this set together in your toolbox.
- Color-coded housing for instant identification of size Series
- Ball-end design allows entry angle of up to 25 degrees for easily reaching around obstructions



STAR KEY SET 6 PCS

KUNCI L BINTANG SET 6 PCS

ITEM CODE	SIZE	CONTENT	WEIGHT (gr)	QTY / BOX INNER/MASTER
HK-ST1211	T25 - T55	T25, T30, T40, T45, T50, T55	538	6 / 30 set

- S2 Materials
- Simple, small, and light
- Easy to use
- Highly durable

Using steel box so that it is easily to stored & safe.

High quality material with proper heat treatment for extra durability and strength

PERMANENT MARKING Easy identification on the key body



TORX KEY SET LONG 6PCS

KUNCI L BINTANG PANJANG SET 6 PCS

ITEM CODE	SIZE	WEIGHT (gr)	QTY / BOX INNER/MASTER
HK-TL1221	T10	53	4 / 100 pcs
HK-TL1222	T15	69	4 / 100 pcs
HK-TL1223	T20	86	4 / 100 pcs
HK-TL1224	T25	109	4 / 100 pcs
HK-TL1225	T27	138	4 / 100 pcs
HK-TL1226	T30	205	4 / 100 pcs
HK-TL1227	T40	309	25 / 50 pcs
HK-TL1228	T45	423	25 / 50 pcs
HK-TL1229	T50	586	25 / 50 pcs

- High durable hardness
- Easy to use
- Simple small and light



- High durable hardness
- Supply torx key function
- Design for falve clearance adjustment

VALVE ADJUSTABLE WRENCH

KUNCI L KLEP MOTOR SET 6 PCS

ITEM CODE	SIZE	CONTENT	1 (mm)	2 (mm)	3 (mm)	WEIGHT (gr)	QTY / BOX INNER/MASTER
HK-AW1230	T - 40	6	161	40	5	478	10 / 60 set

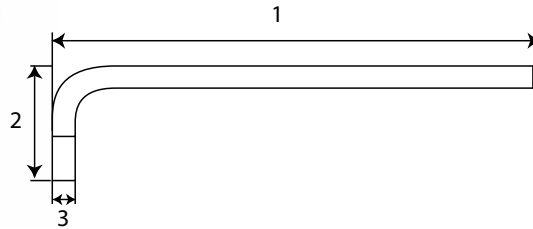

- S2 material with proper heat treatment for extra durability and strength
- Convenient storage rack for hex keys and handle keeps this set together in your toolbox.
- Color-coded housing for instant identification of size Series
- Extra Long type with Precision chamfered ends - for working easy

TAMPER TORX KEY T 20 LONG

KUNCI L BINTANG PANJANG T20 LUBANG

ITEM CODE	SIZE	1 (mm)	2 (mm)	3 (mm)	WEIGHT (gr)	QTY / BOX INNER/MASTER
HK-TL1642	T 20	110	26	4	11	50 / 1000

With center hole 

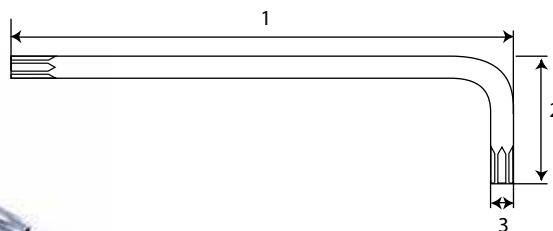





HAMMER

Hammers are used very widely in various fields of work, such as carpentry, buildings, workshops, wood crafts, machinery. Tekiro has many hammer variants needed in this line of work. Here are the available hammer variants :

Handle Type	Head Type	Size
Fiberglass with TPR	Ball Pein	227gr (8OZ), 453gr (16OZ), 680gr (24OZ), 907gr (32OZ)
Fiberglass with TPR	Claw	227gr (8OZ), 340gr (12OZ), 453gr (16OZ),
Fiberglass with TPR	Double Plastic	25mm, 30mm, 35mm, 40mm, 45mm
Fiberglass with TPR	Two Way (Plastic & Rubber)	25mm, 35mm
Fiberglass with TPR	Engineers Cross Pein	20mm, 25mm
Fiberglass with TPR	Mechanist	200gr, 300gr
Fiberglass with TPR	White Rubber	450gr (16 OZ), 680gr (24OZ)
Fiberglass with TPR	Stoning	1000gr (35OZ) , 2000gr (70OZ)
Fiberglass with TPR	Construction	4000gr (141OZ), 6000gr (211OZ)
Hardwood	Cooper	1000gr (35OZ) , 2000G (70OZ)
Hardwood	Nylon	400gr (14OZ)

CLAW HAMMER

Curved claw design for quick nail removal

Finely polished finish with rust-preventative clear coating ensures durability and longevity

Drop forged carbon steel & heat treated process provide maximum striking strength



Handy wall hanging hole

Durable fiberglass handle with non slip rubber for better grip, reduce vibration & fatigue



BALL PEIN HAMMER WITH FIBRE

PALU KONDE

ITEM CODE	SIZE	1 (mm)	2 (mm)	3 (mm)	4 (mm)	5 (mm)	6 (mm)	7 (mm)	WEIGHT (gr)	QTY / BOX INNER/MASTER
GT-BM1233	8 OZ	280	85	24	34	20	20	25	420	6 / 60 pcs
GT-BM1234	16 OZ	325	105	29	40	23	23	27	700	6 / 36 pcs
GT-BM1235	24 OZ	350	118	32	46	25	25	33	1,000	6 / 24 pcs
GT-BM1236	32 OZ	350	127	38	46	26	26	37	1,150	6 / 24 pcs

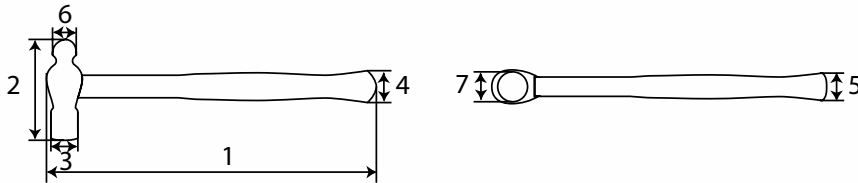

- Clear coated and heat treated carbon steel hammer
- Drop forged for extra strength
- Fiberglass handle with non slip rubber grip



CLAW HAMMER

PALU KAMBING

ITEM CODE	SIZE	1 (mm)	2 (mm)	3 (mm)	4 (mm)	5 (mm)	6 (mm)	7 (mm)	WEIGHT (gr)	QTY / BOX INNER/MASTER
GT-CH1237	8 OZ	270	110	24	37	20	26	22	360	12 / 48 pcs
GT-CH1238	12 OZ	290	125	27	42	24	31	26	513	6 / 36 pcs
GT-CH1239	16 OZ	320	130	30	46	25	33	29	700	6 / 36 pcs

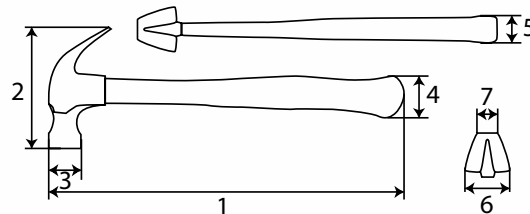

- Clear coated and heat treated carbon steel hammer
- Drop forged for extra strength
- Fiberglass handle with non slip rubber grip



DOUBLE PLASTIC HAMMER

PALU PLASTIK

ITEM CODE	SIZE	1 (mm)	2 (mm)	3 (mm)	4 (mm)	5 (mm)	WEIGHT (gr)	QTY / BOX INNER/MASTER
GT-PH1240	25 mm	280	72	23	27	20	250	6 / 72 pcs
GT-PH1241	30 mm	285	81	27	27	20	300	6 / 60 pcs
GT-PH1242	35 mm	285	85	30	29	20	436	6 / 48 pcs
GT-PH1243	40 mm	300	96	36	32	24	500	6 / 36 pcs
GT-PH1244	50 mm	320	114	44	36	25	920	6 / 24 pcs

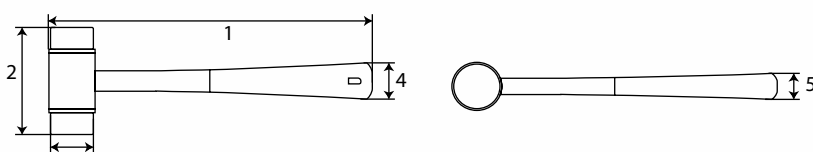

- Rubber handle reduce vibration
- High durable plastic head
- High strength adhesive
- Fibreglass with rubber handle



AUTOMOTIVE

STORAGE

TRAY

AIR TOOLS

HEX KEY

GENERAL TOOLS

- General purpose soft face hammer
- Perfectly balanced
- Plastic on one side & rubber on the other side
- Fibreglass with rubber handle

TWO-WAY HAMMER GREEN & BLACK HEAD

PALU KOMBINASI PLASTIK DAN KARET

ITEM CODE	SIZE	1 (mm)	2 (mm)	3 (mm)	4 (mm)	5 (mm)	WEIGHT (gr)	QTY / BOX INNER/MASTER
GT-TW1515	25 mm	285	62	25	23.0	34.0	210	6 / 36 pcs
GT-TW1516	35 mm	310	86	35	39.0	22.0	430	6 / 36 pcs

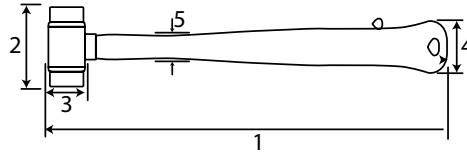

- High durable hardness
- High strength adhesive
- Fibreglass with rubber handle

ENGINEERS CROSS PEIN HAMMER

PALU KETOK LAS TIPE 2

ITEM CODE	SIZE	1 (mm)	2 (mm)	3 (mm)	4 (mm)	5 (mm)	WEIGHT (gr)	QTY / BOX INNER/MASTER
GT-EC1517	20 mm	283	101.0	25	21.0	35.0	310	8 / 48 pcs
GT-EC1518	25 mm	323	118.0	30	27.0	41.0	550	8 / 48 pcs

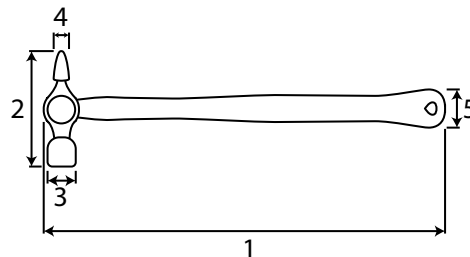

- High durable hardness
- High strength adhesive
- Fibreglass with rubber handle

MACHINIST HAMMER

PALU KETOK LAS TIPE 1

ITEM CODE	SIZE	1 (mm)	2 (mm)	3 (mm)	4 (mm)	5 (mm)	WEIGHT (gr)	QTY / BOX INNER/MASTER
GT-MH1519	200 G	283	96	20	21	35	320	8 / 48 pcs
GT-MH1520	300 G	300	105	25	23	24	470	6 / 36 pcs

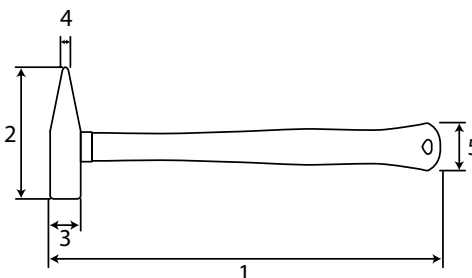

NYLON HAMMER

PALU NILON

- High durable hardness
- High strength adhesive
- Hardwood handle hammer

ITEM CODE	SIZE	1 (mm)	2 (mm)	3 (mm)	4 (mm)	WEIGHT (gr)	QTY / BOX INNER/MASTER
GT-NH1508	40MM = 400 G	312	95	40	40	450	6 / 36 pcs

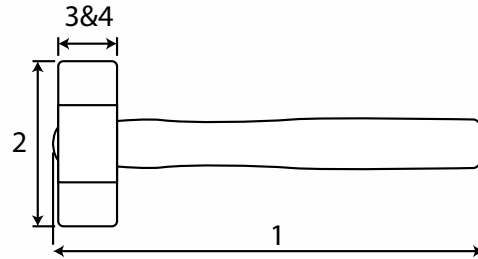

WHITE RUBBER HAMMER

PALU KARET

- High durable hardness
- High strength adhesive
- Fibreglass with rubber handle

ITEM CODE	SIZE	1 (mm)	2 (mm)	3 (mm)	4 (mm)	5 (mm)	WEIGHT (gr)	QTY / BOX INNER/MASTER
GT-WH1509	450 gr	330	92.5	62	38.7	21.9	670	4 / 24 pcs
GT-WH1510	680 gr	350	112.0	71	40.5	24.1	950	4 / 24 pcs

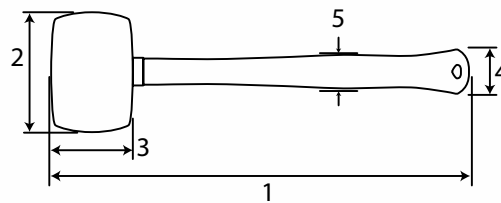

COPPER HAMMER

PALU TEMBAGA

- General purpose soft face hammer
- Hardwood handle hammer
- Perfectly balanced

ITEM CODE	SIZE	1 (mm)	2 (mm)	3 (mm)	4 (mm)	5 (mm)	6 (mm)	WEIGHT (gr)	QTY / BOX INNER/MASTER
GT-CH1511	1 KG	260	95	39	37.5	35	24	1,150.0	2 / 12 pcs
GT-CH1512	2 KG	306	118	47	46	38	27	2,200.0	2 / 12 pcs

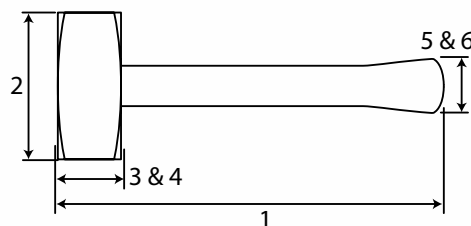

AUTOMOTIVE

STORAGE

TRAY

AIR TOOLS

HEX KEY

GENERAL TOOLS

- High durable hardness
- High strength adhesive
- Comfort & anti slip grip
- Specially for construction
- Fibreglass with rubber handle



STONING HAMMER

PALU BATU

ITEM CODE	SIZE	1 (mm)	2 (mm)	3 (mm)	4 (mm)	5 (mm)	WEIGHT (gr)	QTY / BOX INNER/MASTER
GT-SH1513	1000 g	275	95	40	40.0	28.5	1,250	2 / 12 pcs
GT-SH1514	2000 g	303	120	50	40.0	28.5	2,250	2 / 12 pcs

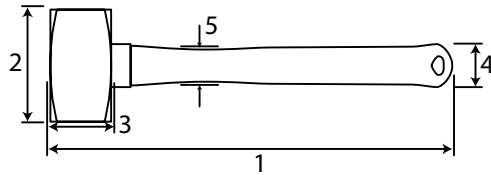

- High durable hardness
- High strength adhesive
- Fibreglass with rubber handle

CONSTRUCTION HAMMER

PALU BATU GAGANG PANJANG

ITEM CODE	SIZE	1 (mm)	2 (mm)	3 (mm)	4 (mm)	5 (mm)	6 (mm)	WEIGHT (gr)	QTY / BOX INNER/MASTER
GT-HC1795	4 kg	885	61	61	65	40	37	4,300	2 / 2 pcs
GT-HC1796	6 kg	895	72	72	90	41	40	6,750	2 / 2 pcs

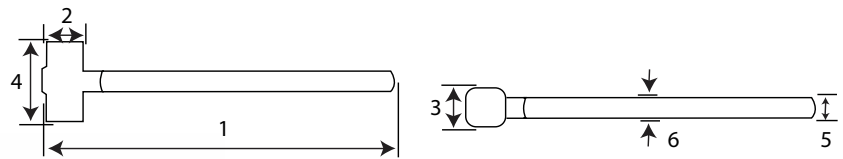

- Ergonomically Handle Design
- Fine Polishing
- Roundhead Design
- Widely Used

WOODEN HAMMER

PALU KONDE GAGANG KAYU

ITEM CODE	SIZE	1 (mm)	2 (mm)	3 (mm)	4 (mm)	5 (mm)	6 (mm)	7 (mm)	WEIGHT (gr)	QTY / BOX INNER/MASTER
GT-WH1943	24 OZ	882	116	36	34	27	32	35	930	6 / 24 pcs

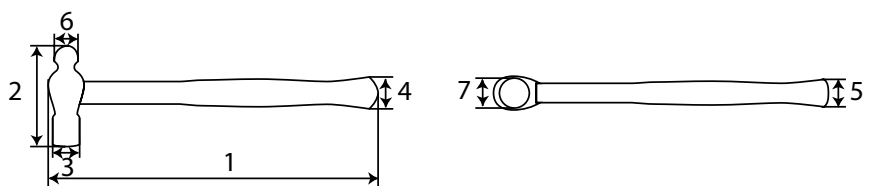



AUTOMOTIVE

STORAGE

TRAY

AIR TOOLS

HEX KEY

GENERAL TOOLS

BENCH VISE STEEL BODY

Rigid and robust, the body and sliding jaw are from SG iron which is machined on all friction surfaces for a smooth, reliable action. The jaws, handle and main screw are steel.

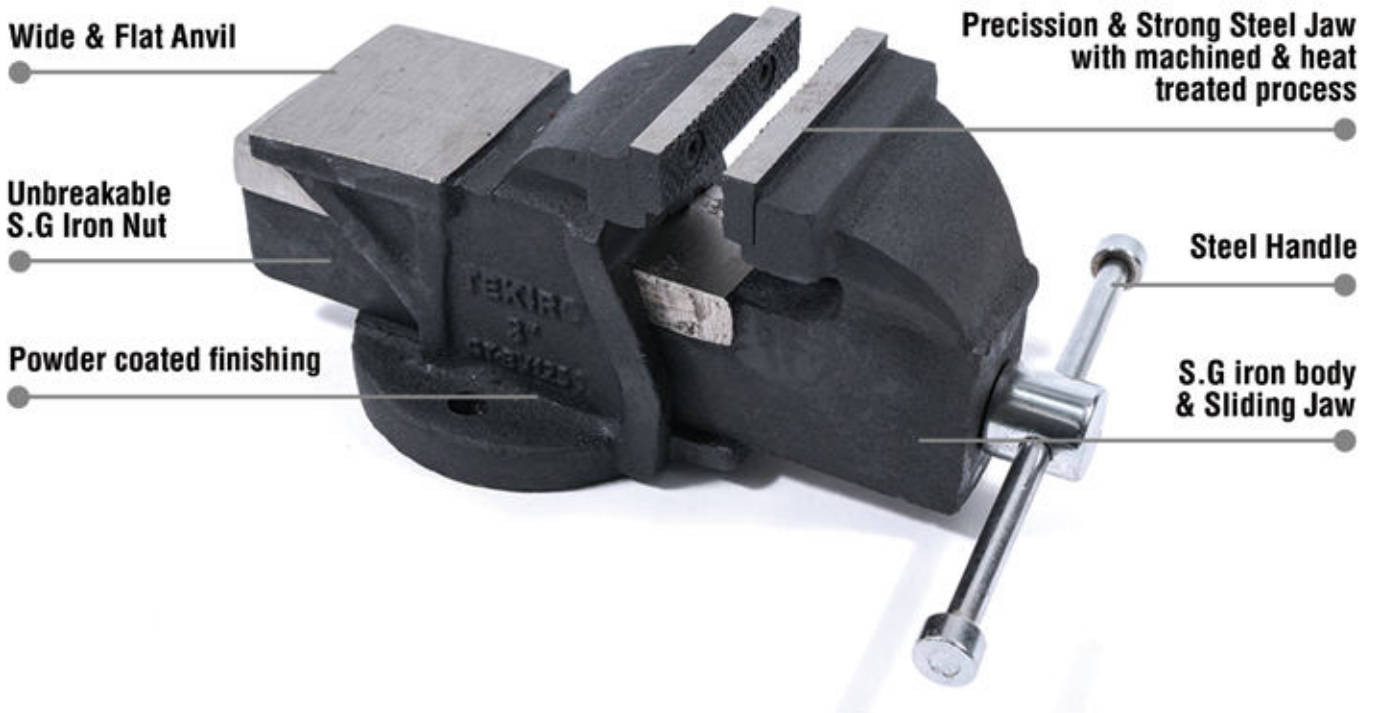

- Precision jaws
- Ergonomic handle
- Wide and flat anvil

BENCH VISE STEEL BODY

CATOK MEJA

ITEM CODE	SIZE	1 (mm)	2 (mm)	3 (mm)	4 (mm)	5 (mm)	6 (mm)	7 (mm)	MAX JAW OPENING (mm)	WEIGHT (gr)	QTY / BOX INNER/MASTER
GT-BV1250	3"	230	25	123	13	70	78	152	80	5,480	1 / 1 pcs
GT-BV1251	4"	280	27	142	16	83	83	203	110	8,580	1 / 1 pcs
GT-BV1252	5"	330	31	166	19	103	132	230	140	13,000	1 / 1 pcs
GT-BV1253	6"	360	40	196	19	116	158	230	180	15,220	1 / 1 pcs
GT-BV1254	8"	430	38	216	17	111	207	230	240	23,000	1 / 1 pcs
GT-BV1255	10"	490	38	217	17	129	235	265	290	25,500	1 / 1 pcs

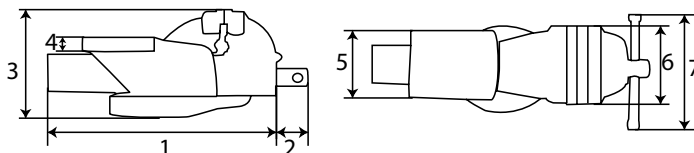

LETTER PUNCH GERMANY STYLE SET

HURUF KETOK

ITEM CODE	SIZE	1 (mm)	2 (mm)	3 (mm)	WEIGHT (gr)	QTY / BOX INNER/MASTER
GT-LP1256	1,5 mm	60	5	5	430	10 / 30 set
GT-LP1257	2 mm	61	5	5	448	10 / 30 set
GT-LP1258	2,5 mm	60	7	7	462	10 / 30 set
GT-LP1259	3 mm	60	7	7	462	10 / 30 set
GT-LP1260	4 mm	60	7	7	635	10 / 30 set
GT-LP1261	5 mm	60	7	7	735	10 / 20 set
GT-LP1262	6 mm	63	8	8	1,040	10 / 20 set
GT-LP1263	8 mm	66	9	9	1,360	5 / 10 set
GT-LP1264	10 mm	69	12	12	2,068	5 / 10 set
GT-LP1265	12 mm	75	14	13	3,070	5 / 10 set

- Great for permanently marking metals, plastics, leather and wooden items
- All stamps and contents are made of high quality chrome vanadium steel for strength and hardness
- Every stamp is precisely machined to ensure all stamps are of the same size



NUMBER PUNCH GERMANY STYLE SET

NOMOR KETOK

ITEM CODE	SIZE	1 (mm)	2 (mm)	3 (mm)	WEIGHT (gr)	QTY / BOX INNER/MASTER
GT-NP1266	1,5 mm	60	5	6	153	25 / 100 set
GT-NP1267	2 mm	61	6	6	156	25 / 100 set
GT-NP1268	2,5 mm	61	6	6	157	25 / 100 set
GT-NP1269	3 mm	61	6	6	156	25 / 100 set
GT-NP1270	4 mm	61	6	6	212	25 / 100 set
GT-NP1271	5 mm	61	6	6	251	25 / 50 set
GT-NP1272	6 mm	63	6	6	348	25 / 50 set
GT-NP1273	8 mm	66	9	9	467	25 / 50 set
GT-NP1274	10 mm	69	12	12	682	10 / 20 set
GT-NP1275	12 mm	74	13	13	1,048	10 / 20 set

- Great for permanently marking metals, plastics, leather and wooden items
- All stamps and contents are made of high quality chrome vanadium steel for strength and hardness
- Every stamp is precisely machined to ensure all stamps are of the same size



PADLOCK SHORT

GEMBOK PENDEK

ITEM CODE	SIZE	1 (mm)	2 (mm)	3 (mm)	4 (mm)	5 (mm)	6 (mm)	7 (mm)	WEIGHT (gr)	QTY / BOX INNER/MASTER
GT-PL1432	40 mm	32	40	19	60	6	23	21	233	6 / 72 pcs
GT-PL1433	50 mm	38	49	19	75	9	30	28	337	6 / 36 pcs
GT-PL1434	60 mm	41	59	19	87	10	38	36	434	6 / 36 pcs
GT-PL1435	70 mm	45	70	19	101	11	45	43	556	6 / 24 pcs

- Material chrome vanadium
- Cylinder and pin 100% cooper
- High secure lock
- Carbon steel body
- Satin finish

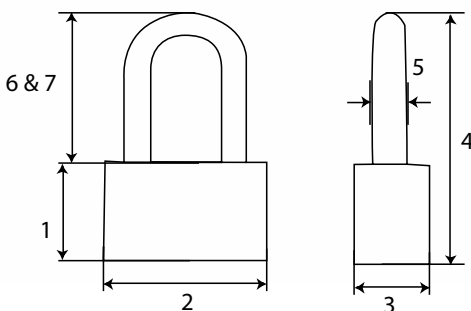

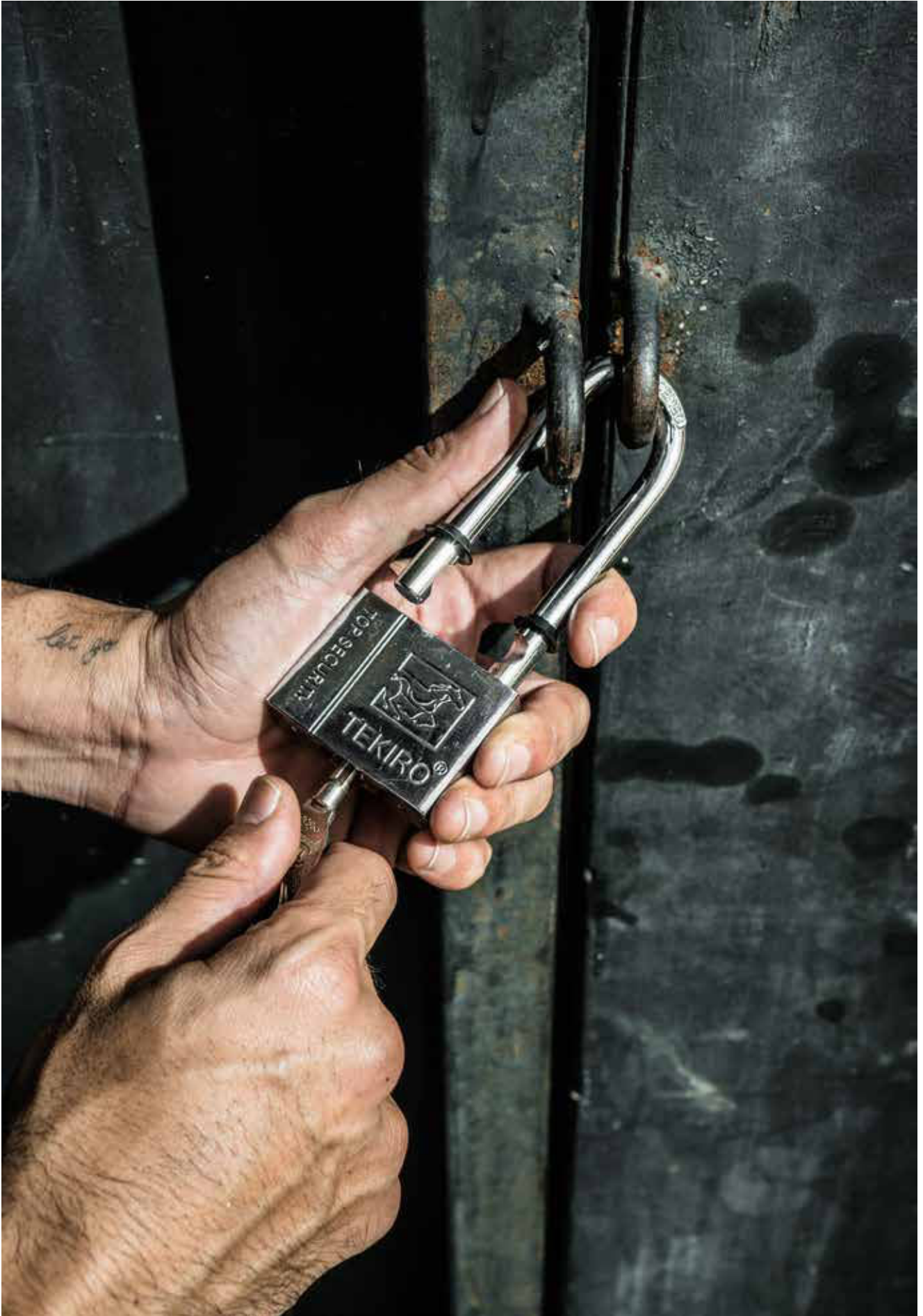

PADLOCK LONG

GEMBOK PANJANG

ITEM CODE	SIZE	1 (mm)	2 (mm)	3 (mm)	4 (mm)	5 (mm)	6 (mm)	7 (mm)	WEIGHT (gr)	QTY / BOX INNER/MASTER
GT-PL1436	40 mm	31	39	19	89	7	52	50	250	6 / 72 pcs
GT-PL1437	50 mm	38	50	19	104	10	59	57	382	6 / 36 pcs
GT-PL1438	60 mm	42	60	20	113	11	62	60	471	6 / 36 pcs

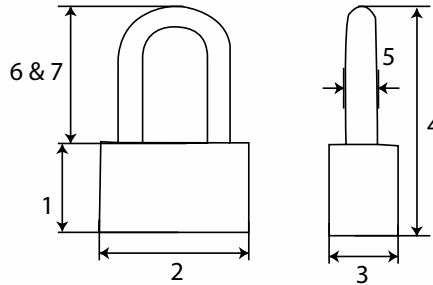

PADLOCK JACKET

GEMBOK TIPE JAKET

ITEM CODE	SIZE	1 (mm)	2 (mm)	3 (mm)	4 (mm)	WEIGHT (gr)	QTY / BOX INNER/MASTER
GT-PJ1841	40 mm	64	6	19	40	200	6 / 72 pcs
GT-PJ1842	50 mm	75	9	20	50	380	6 / 36 pcs
GT-PJ1843	60 mm	80	10	19	60	500	6 / 36 pcs
GT-PJ1844	70 mm	100	12	21	70	725	6 / 24 pcs

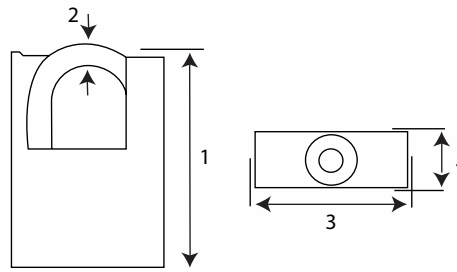

- Satin finish
- Corrosion resistance
- More safety



HOSE CLIP

KLEM SELANG

ITEM CODE	SIZE	1 (mm)	2 (mm)	WEIGHT (gr)	QTY / BOX INNER/MASTER
GT-CH1680	1/2"	15	8	5	200 / 2000 pcs
GT-CH1681	5/8"	12	8	5.5	200 / 2000 pcs
GT-CH1682	3/4"	20	13	5.9	200 / 2000 pcs
GT-CH1683	7/8"	25	8	6	200 / 2000 pcs
GT-CH1684	1"	26	8	6.35	200 / 2000 pcs
GT-CH1685	1-1/4"	33	11	16.5	100 / 1000 pcs
GT-CH1686	1-1/2"	39	12.5	17.5	100 / 1000 pcs
GT-CH1687	2"	52	13	21.6	100 / 1000 pcs
GT-CH1688	2-1/2"	63	13	23.4	100 / 1000 pcs
GT-CH1689	3"	74	13	25.2	50 / 500 pcs
GT-CH1690	4"	100	13	31.3	50 / 500 pcs

- High quality stainless steel material
- Smooth edge
- Well polished surface
- Fit for thin wall hose in small size

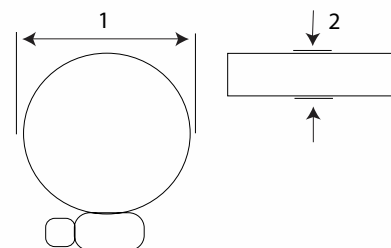

AUTOMOTIVE

STORAGE

TRAY

AIR TOOLS

HEX KEY

GENERAL TOOLS



CUTTER KNIFE

Tekiro Cutter Knife is sharp, lightweight and durable. It is versatile for light duty jobs like opening carton boxes to heavy duty carpet cutting. Everyone should own one!

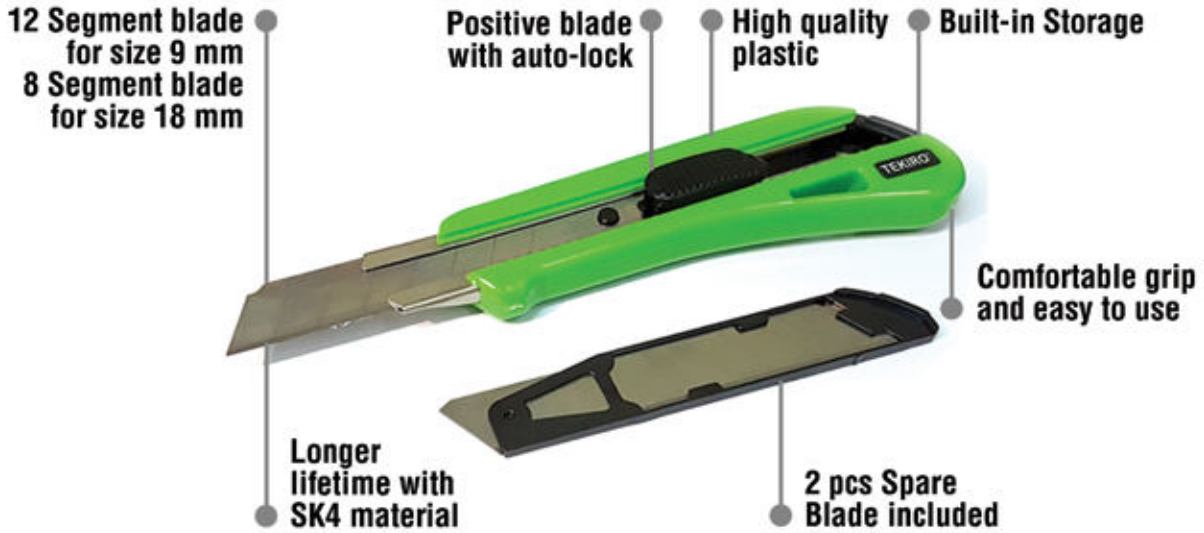

CHISEL

TEKIRO Chisels have several sizes to accommodate the craftmans' needs. The high durable and quality steel ensures the chisel stays sharp longer and able to tackle the most intricate job effortlessly.

TYPE	SIZE
Wood Chisel	1/4" , 3/8" , 1/2" , 5/8" , 3/4" , 1" , 1-1/4" , 1-1/2"
Concrete Point Chisel	8" , 10" , 12"
Concrete Flat Chisel	8" , 10" , 12"

WOOD CHISEL

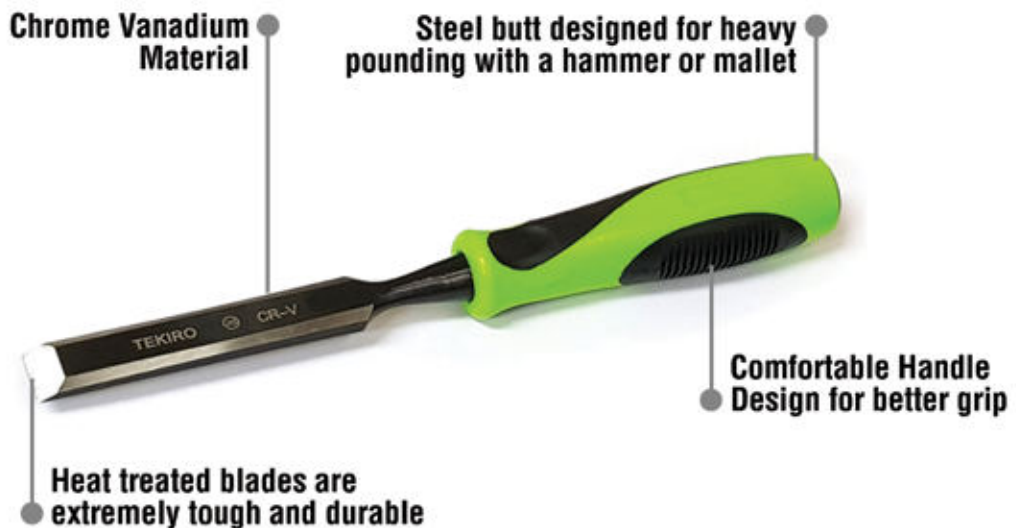

CUTTER KNIFE

PISAU CUTTER

ITEM CODE	SIZE	1 (mm)	2 (mm)	THICKNESS BLADE (mm)	WEIGHT (gr)	QTY / BOX INNER/MASTER
GT-PC1561	9 mm	9	140	0.20	37.0	24 / 192 pcs
GT-CK1821	18 mm	18	154	0.25	90.5	12 / 120 pcs

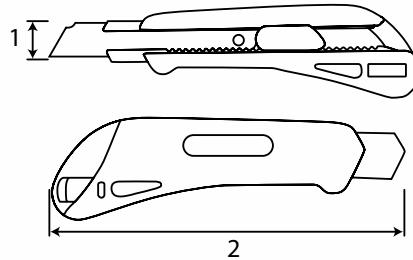

- High quality plastic
- Comfortable grip and easy to use
- Spare blade on behind
- SK4 Blade



PUNCH AND CHISEL SET 7 PCS

PAHAT SET 7 PCS

ITEM CODE	CONTENT	WEIGHT (gr)	QTY / BOX INNER/MASTER
GT-PC1278	7 pcs Punch & Chisel 5/8", 1/2", 3/8", 5/32" 7/32, 1/8", 3/16"	615	10 / 40 set

- Special alloy steel is friction-welded on the edge for more strength and durability
- Chrome plated surface for rust resistance



WOOD CHISEL

PAHAT KAYU

ITEM CODE	SIZE	1 (mm)	2 (mm)	3 (mm)	4 (mm)	Weight (gr)	QTY / BOX INNER/MASTER
GT-WC1660	1/4" - 6,5 mm	252	120	6	30	139.5	6 / 60 pcs
GT-WC1661	3/8" - 10 mm	254	123	10	30	154.5	6 / 60 pcs
GT-WC1662	1/2" - 13 mm	251	121	11	30	178.5	6 / 60 pcs
GT-WC1663	5/8" - 16 mm	270	139	16	28	216.5	6 / 60 pcs
GT-WC1664	3/4" - 19 mm	268	136	19	28	220.0	6 / 60 pcs
GT-WC1665	1" - 25 mm	268	138	25	28	240.0	6 / 60 pcs
GT-WC1666	1-1/4" - 32 mm	277	146	37	27	288.5	6 / 60 pcs
GT-WC1667	1-1/2" - 38 mm	277	146	37	27	298.5	6 / 60 pcs

- Chrome vanadium material
- Rust resistance
- Rubber handle with striking metal cap provides maximum comfort and shocks absorption

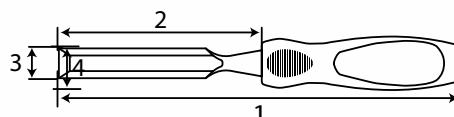

AUTOMOTIVE

STORAGE

TRAY

AIR TOOLS

HEX KEY

GENERAL TOOLS

- Comfort & anti slip grip
- Sharp and precise edge
- Can be use for most type of wood
- Chrome vanadium material
- Rust resistance
- The handle is rubber to prevent slippage



WOOD CHISEL SET 3 PCS

PAHAT KAYU SET 3 PCS

ITEM CODE	SIZE	1 (mm)	2 (mm)	3 (mm)	WEIGHT (gr)	QTY / BOX INNER/MASTER
GT-WC1747	1 Pc 1/2" 13 mm	250	121	13	720	5 / 20 pcs
	1 Pc 3/4" 19 mm	266	136	19		
	1 Pc 1" 25 mm	282	138	25		

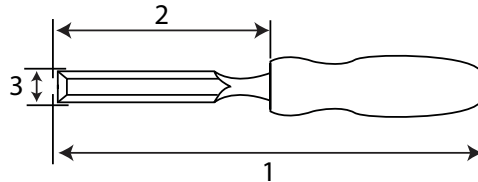

- High quality carbon steel
- Metal Striking cap
- Soft grip handle
- Special alloy steel is friction-welded on the edge for more strength and durability
- Chrome plated surface for rust resistance
- Safety handle design



CONCRETE POINT CHISEL

PAHAT BETON LANCIP

ITEM CODE	SIZE	1 (mm)	2 (mm)	3 (mm)	4 (mm)	WEIGHT (gr)	QTY / BOX INNER/MASTER
GT-PC1838	8"	200	70	136	16	410	6 / 24 pcs
GT-PC1839	10"	255	115	140	16	600	6 / 24 pcs
GT-PC1840	12"	298	167	131	17	580	6 / 24 pcs

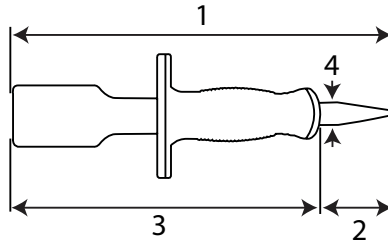

- High quality carbon steel
- Metal Striking cap
- Soft grip handle
- Special alloy steel is friction-welded on the edge for more strength and durability
- Chrome plated surface for rust resistance
- Safety handle design



CONCRETE FLAT CHISEL

PAHAT BETON PIPIH

ITEM CODE	SIZE	1 (mm)	2 (mm)	3 (mm)	4 (mm)	WEIGHT (gr)	QTY / BOX INNER/MASTER
GT-FC1835	8"	200	66	133	16	440	6 / 24 pcs
GT-FC1836	10"	248	118	131	16	520	6 / 24 pcs
GT-FC1837	12"	290	167	133	16	610	6 / 24 pcs

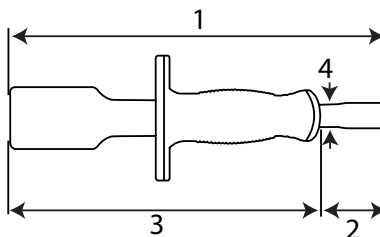

BOX LEVEL

WATERPASS

- Shockproof end caps
- UV resistant
- Magnetic
- High accuracy

ITEM CODE	SIZE	1 (mm)	2 (mm)	3 (mm)	WEIGHT (gr)	QTY / BOX INNER/MASTER
GT-WP1711	12"	296	48	19	204	10 / 60 pcs
GT-WP1712	16"	395	48	19	262	10 / 60 pcs
GT-WP1713	18"	449	48	19	281	10 / 60 pcs
GT-WP1714	20"	499	48	19	294	10 / 60 pcs
GT-WP1715	24"	602	48	19	329	10 / 60 pcs
GT-WP1716	32"	602	48	19	423	10 / 40 pcs
GT-WP1717	40"	998	48	19	500	10 / 40 pcs
GT-WP1718	60"	1,497	48	19	766	1 / 10 pcs
GT-WP1719	80"	1,997	48	19	885	1 / 10 pcs

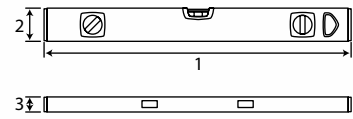

TAP AND DIES SET 40 PCS

TAP AND DIES SET40 PCS

- Heat Treated and Hardened
- High quality steel
- Compartmentalized storage case

ITEM CODE	CONTENT	WEIGHT (gr)	QTY / BOX INNER/MASTER
GT-TD1726	Dies M3 X 0.5	1,100	1 / 10 set
	Dies M4 X 0.7		
	Dies M5 X 0.8		
	Dies M6 X 1.0		
	Dies M7 X 1.0		
	Dies M8 X 1.25		
	Dies M10 X 1.5		
	Dies M12 X 1.75		
	Dies 1/8NPT27		
	Dies 4NC40		
	Dies 6NC32		
	Dies 8NC32		
	Dies 1/4NC20		
	Dies 5/16NC18		
	Dies 3/8NC16		
	Dies 7/16NC14		
	Dies 1/2NC13		
	Tap M3 X 0.5		
	Tap M4 X 0.7		
	Tap M5 X 0.8		
	Tap M6 X 1.0		
	Tap M7 X 1.0		
	Tap M8 X 1.25		
	Tap M10 X 1.5		
	Tap M12 X 1.75		
	Tap 1/8NPT27		
	Tap 4NC40		
	Tap 6NC32		
	Tap 1/4NC20		
	Tap 5/16NC18		
	Tap 3/8NC16		
	Tap 7/16NC14		
	Tap 1/2NC13		
Tap Wrench			
Die Handle 1"OD			
T-Type Wrench 1/4" Capacity			
Screwpitch Gauge			
Screwdriver			



AUTOMOTIVE

STORAGE

TRAY

AIR TOOLS

HEX KEY

GENERAL TOOLS

- High quality 9 CrSi Material
- Strong & Durable
- Easy to use

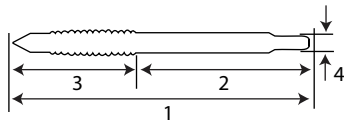

- Polished Finish
- Knurled handle for excellent grip
- Hardened steel jaws



- High Fully Polishing Finish
- Drop Forged for extra strength
- Three position gear box



HAND TAPS SET 3 PCS

HAND TAPS SET 3 PCS

ITEM CODE	SIZE	1 (mm)	2 (mm)	3 (mm)	4 (mm)	WEIGHT (gr)	QTY / BOX INNER/MASTER
GT-HT1852	M3 X 0.5	47.5	24.5	21.55	3	10	100 / 400 pcs
GT-HT1853	M4 X 0.7	53	32	23	4	20	100 / 400 pcs
GT-HT1854	M5 X 0.8	62.5	23	32	4	40	70 / 280 pcs
GT-HT1855	M6 X 1.0	64	34	29	5	40	70 / 280 pcs
GT-HT1856	M8 X 1.25	70	40	30	5	50	32 / 128 pcs
GT-HT1857	M10 X 1.5	75.5	43	31.5	5.5	80	32 / 128 pcs
GT-HT1858	M12 X 1.75	80.5	42.5	37.5	6	100	20 / 80 pcs
GT-HT1859	M14 X 2	84.5	42.5	41	8	170	14 / 56 pcs
GT-HT1860	M16 X 2.0	89.5	44	45	10	200	14 / 56 pcs
GT-HT1861	M18 X 2.5	99	51	46	11	250	5 / 20 pcs
GT-HT1862	M20 X 2.5	104.5	54	50.5	12	440	5 / 20 pcs

HANDLE TAP

GAGANG TAP

ITEM CODE	SIZE	1 (mm)	2 (mm)	3 (mm)	4 (mm)	5 (mm)	WEIGHT (gr)	QTY / BOX INNER/MASTER
GT-HT1863	M1-M10	198	64	70	64	7	100	10 / 100 pcs
GT-HT1864	M3-M12	223	71	70	78	8	130	10 / 100 pcs

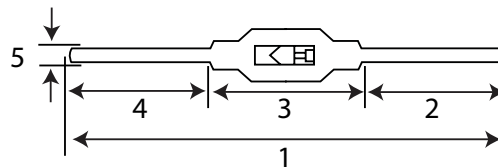

RATCHET HANDLE TAP

GAGANG TAP RATCHET

ITEM CODE	SIZE	1 (mm)	2 (mm)	3 (mm)	4 (mm)	5 (mm)	WEIGHT (gr)	QTY / BOX INNER/MASTER
GT-RH1865	M3-M10	85	100	7	19	20	190	10 / 100 pcs
GT-RH1866	M5-M12	111	120	7.5	21	25	310	8 / 64 pcs

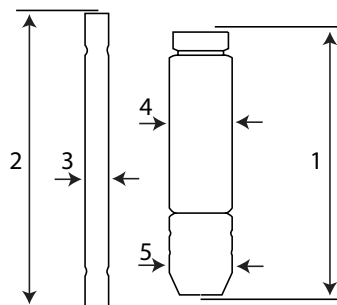

HACKSAW

TEKIRO high-quality hacksaw provides improved cutting performance. Their tooth geometry delivers high resistance against tooth rippage and increases longevity and durability.

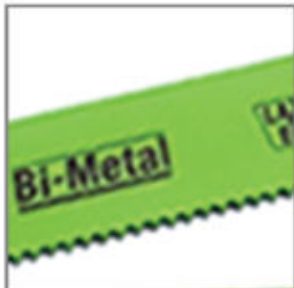

M42 (with cobalt) high speed steel cutting edge

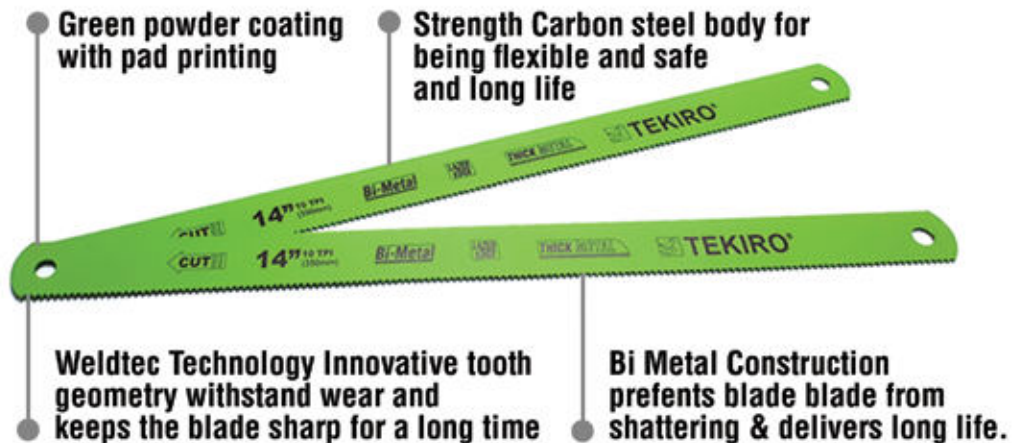

AUTOMOTIVE

STORAGE

TRAY

AIR TOOLS

HEX KEY

GENERAL TOOLS

- Bi Metal
- Flexible
- Shatter resistant
- Suitable for use on a variety of metals
- Improved cutting performance



SAW BLADE

MATA GERGAJI BESI - TANGAN

ITEM CODE	SIZE	1 (mm)	2 (mm)	WEIGHT (gr)	QTY / BOX INNER/MASTER
GT-SB1483	18 TPI	315	12	19	100 / 1000 pcs
GT-SB1484	24 TPI	315	12	19	100 / 1000 pcs

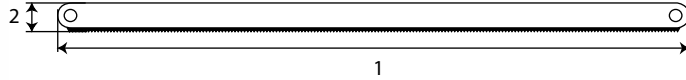

- Bi Metal
- Flexible
- Shatter resistant
- Suitable for use on a variety of metals
- Improved cutting performance



POWER HACKSAW BLADES 10 TPI

MATA GERGAJI BESI 10 TPI - MESIN

ITEM CODE	SIZE	1 (mm)	2 (mm)	WEIGHT (gr)	QTY / BOX INNER/MASTER
GT-PH1729	14"				20 / 200 pcs
GT-PH1730	16"				20 / 200 pcs

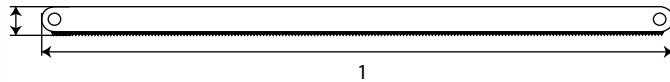

- Solid aluminum frame
- Cutting angle 45 and 90 degree
- Comfort anti slip grip



HACKSAW

GERGAJI BESI

ITEM CODE	SIZE	1 (mm)	2 (mm)	3 (mm)	4 (mm)	5 (mm)	WEIGHT (gr)	QTY / BOX INNER/MASTER
GT-HS1623	12"	370	359	208	132	124.0	599.5	12 / 36 pcs

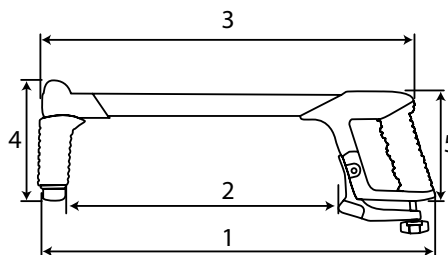

HANDSAW

TEKIRO handsaw has several product variants with different types of handles and tooth types according to user needs. The following variants are available:

Handle Type	Tooth Type	Size
TPR	Two Teeth (Double Ground)	18" , 20"
TPR	Three Teeth (Triple Ground)	18" , 20"
Wooden	Two Teeth (Double Ground)	18" , 20"
Wooden	Three Teeth (Triple Ground)	18" , 20"

HANDSAW 3 TEETH

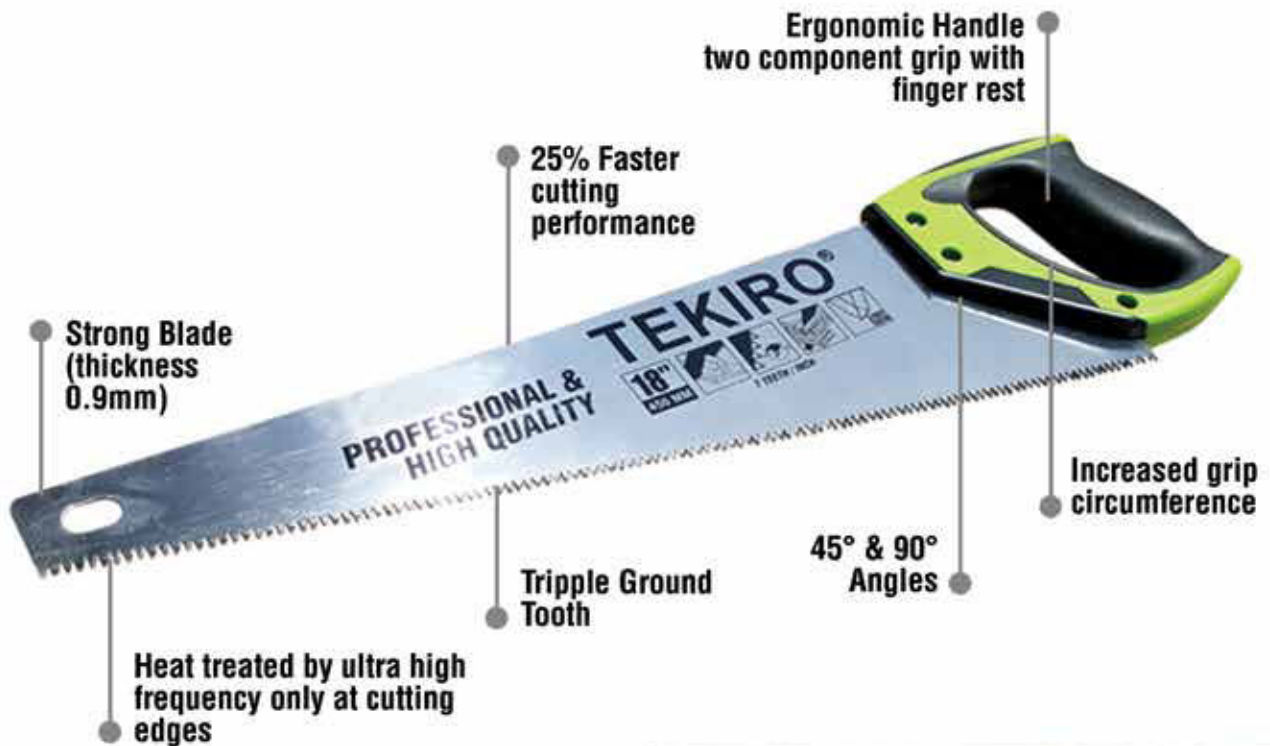

- Double Ground Tooth
- Blade thickness 0.9mm
- Hard Point, stays sharp longer
- Universal tooth
- Medium 7T/8P
- Ergonomically designed 2 component grip handle grip

HANDSAW 2 TEETH

GERGAJI KAYU GAGANG TPR 2 MATA

ITEM CODE	SIZE	1 (mm)	2 (mm)	3 (mm)	4 (mm)	5 (mm)	WEIGHT (gr)	QTY / BOX INNER/MASTER
GT-HS1556	18"	520	457	137	35	116	387	12 / 48 pcs
GT-HS1557	20"	572	508	137	35	116	416	12 / 48 pcs

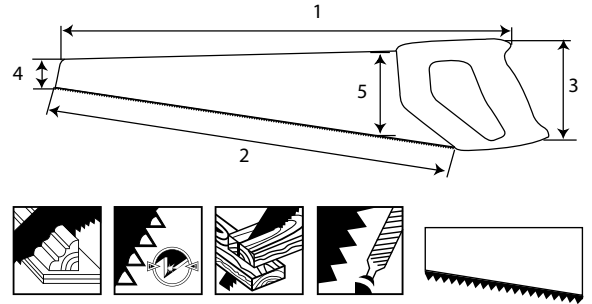

- Triple Ground Tooth
- Tooth tip heat treated by Ultra High Frequency technique
- Blade thickness 0.9mm
- Jet Set, hardened tooth, stays sharp 5x longer
- Universal tooth
- Medium 7T/8P
- Ergonomically designed 2 component handle grip

HANDSAW 3 TEETH

GERGAJI KAYU GAGANG TPR 3 MATA

ITEM CODE	SIZE	1 (mm)	2 (mm)	3 (mm)	4 (mm)	5 (mm)	WEIGHT (gr)	QTY / BOX INNER/MASTER
GT-HS1554	18"	515	457	128	35	116	430	12 / 48 pcs
GT-HT1555	20"	565	508	128	35	116	468	12 / 48 pcs

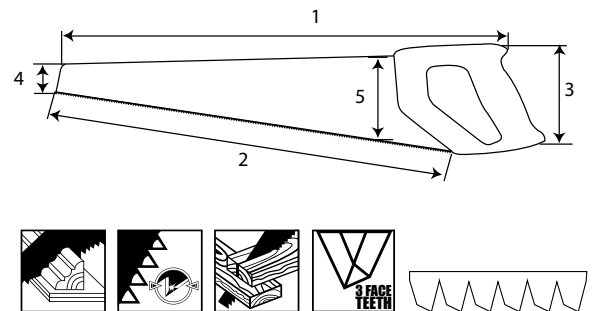

HANDSAW WOODEN HANDLE TWO TEETH

GERGAJI KAYU GAGANG KAYU 2 MATA

ITEM CODE	SIZE	1 (mm)	2 (mm)	3 (mm)	4 (mm)	5 (mm)	WEIGHT (gr)	QTY / BOX INNER/MASTER
GT-HW1713	18"	534	454	123	35	109	419	10 / 40 pcs
GT-HW1714	20"	579	504	121	35	110	430	10 / 40 pcs

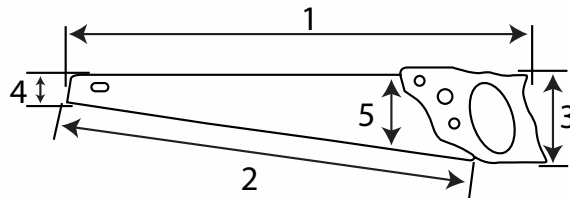

- Double Ground Tooth
- Blade thickness 0.9mm
- Hard Point, stays sharp longer
- Universal tooth
- Medium 7T/8P
- Traditional Wooden Handle grip



HANDSAW WOODEN HANDLE THREE TEETH

GERGAJI KAYU GAGANG KAYU 3 MATA

ITEM CODE	SIZE	1 (mm)	2 (mm)	3 (mm)	4 (mm)	5 (mm)	WEIGHT (gr)	QTY / BOX INNER/MASTER
GT-HW1711	18"	534	454	123	35	109	418	10 / 40 pcs
GT-HW1712	20"	549	504	121	35	110	430	10 / 40 pcs

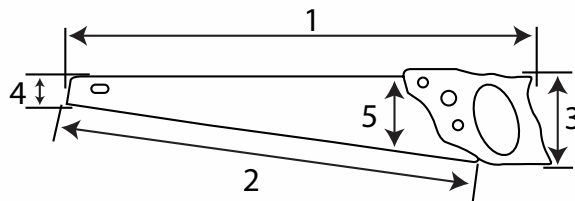

- Triple Ground Tooth
- Blade thickness 0.9mm
- Jet Set, hardened tooth, stays sharp 5x longer
- Universal tooth
- Medium 7T/8P
- Traditional Wooden Handle grip



TENON SAW SET

GERGAJI FIGURA

ITEM CODE	SIZE	1 (mm)	2 (mm)	3 (mm)	4 (mm)	5 (mm)	WEIGHT (gr)	QTY / BOX INNER/MASTER
GT-PS1716	12"	410	300	117	100	22	714	6 / 12 pcs

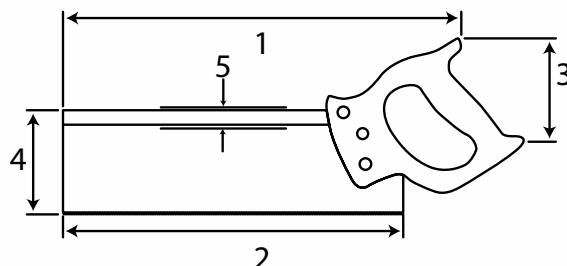

- Fine tooth for precision cutting
- Comes with Mitre block at 45 and 90 degree angles.
- Ridgid blade backing for accurate cut
- Hardened tooth that last longer



AUTOMOTIVE

STORAGE

TRAY

AIR TOOLS

HEX KEY

GENERAL TOOLS

FILE TERMINOLOGY

COARSENESS



Bastard Cut



Second Cut



Smooth Cut

- Work to be accomplished, roughing or finishing will determine type of teeth and coarseness of each application
- Most American pattern files are available with 3 grades of cut : bastard-cut, second-cut and smooth-cut
- The degree of coarseness is greater in longer files, but differences between bastard, second and smooth are proportionate

LENGHT

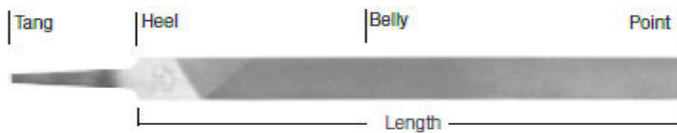

- Length is measured exclusive of tang, from point to heel, unless otherwise specified
- Desired stroke length, type of material and size will determine length required

SHAPE



- Area to be filed will determine specific cross-section (round, half-round, flat, etc.) to be used

Kind of Teeth Single Cut



- Single set of parallel, diagonal rows of teeth
- Single-cut files are often used with light pressure to produce a smooth surface finish or to put a keen edge on knives, shears or saws

Double Cut



- 2 set of diagonal rows of teeth
- Second set of teeth cut in opposite diagonal direction and on top of the first set
- First set of teeth is known as the overcut, second is known as upcut

CHAINSAW FILES

KIKIR MESIN CHAINSAW

ITEM CODE	SIZE	1 (mm)	2 (mm)	3 (mm)	4 (mm)	WEIGHT (gr)	QTY / BOX INNER/MASTER
GT-CF1748	4.8 X 200 MM	243	200	45	4	29.5	24 / 240 pcs
GT-CF1749	5.5 X 200 MM	243	200	45	5	37.5	24 / 240 pcs

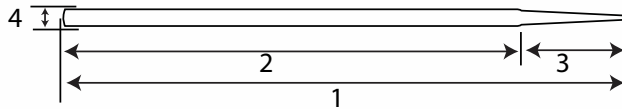

- Double Cut Files
- Fully Heat Treated
- High Durable Hardness



TRIANGULAR FILES

KIKIR SEGITIGA

ITEM CODE		SIZE	1 (mm)	WEIGHT (gr)	QTY / BOX INNER/MASTER
Bastard - Cut	Smooth - Cut				
GT-TB1549	GT-TS1545	6"	150	97	24 / 192 pcs
GT-TB1550	GT-TS1546	8"	200	117	24 / 96 pcs
GT-TB1551	GT-TS1547	10"	250	153	12 / 72 pcs
GT-TB1552	GT-TS1548	12"	300	208	12 / 48 pcs



- For general use by machinists for filling internal angles more acute than right angles, cleaning out square corners and filling taps and gutters
- Triangular shape
- Double-cut
- Sharp corners are slightly set and cut
- Cut to the point



FLAT FILES

KIKIR PLAT

ITEM CODE		SIZE	1 (mm)	2 (mm)	3 (mm)	WEIGHT (gr)	QTY / BOX INNER/MASTER
Bastard Cut	Smooth Cut						
GT-FB1525	GT-FS1521	6"	195	150	12	113	24 / 192 pcs
GT-FB1526	GT-FS1522	8"	247	200	48	167	24 / 96 pcs
GT-FB1527	GT-FS1523	10"	300	250	50	292	12 / 72 pcs
GT-FB1528	GT-FS1524	12"	370	300	70	479	12 / 48 pcs

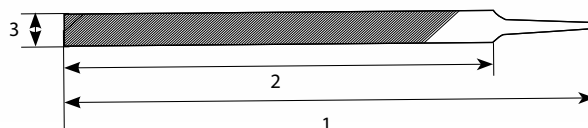

- Used by machinists, machinery builders, ship and engine builders, repairman and others who required rapid removal of metal
- Rectangular in cross section and taper slightly towards point in width
- Double-cut on sides, single-cut on edges
- Available in bastard-cut and smooth-cut



- Fully heat treated
- Edges set and cut for filling gullets between saw teeth
- Tapered slightly towards point



SLIM TAPER SAW FILES

KIKIR SLIM

ITEM CODE	SIZE	1 (mm)	2 (mm)	3 (mm)	WEIGHT (gr)	QTY / BOX INNER/MASTER
GT-ST1635	3"	112	75	2	27	24 / 480 pcs
GT-ST1636	3.5"	124	88	2	29	24 / 480 pcs
GT-ST1553	4"	137	100	3	31	24 / 480 pcs

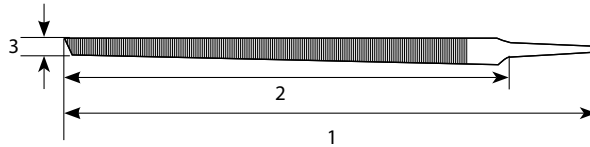

- Used on concave, convex and flat surfaces
- Rounded on 1 side, flat on opposite
- Backs of all half-round bastard files are double-cut
- Backs of all half-round smooth files are single-cut
- Flat sides of all half-round files are double-cut



HALF - ROUND FILES

KIKIR SETENGAH LINGKARAN

ITEM CODE		SIZE	1 (mm)	2 (mm)	3 (mm)	WEIGHT (gr)	QTY / BOX INNER/MASTER
Bastard - Cut	Smooth - Cut						
GT-HB1533	GT-HS1529	6"	195	150	13	92	24 / 192 pcs
GT-HB1534	GT-HS1530	8"	247	200	16	167	24 / 96 pcs
GT-HB1535	GT-HS1531	10"	300	250	19	292	12 / 72 pcs
GT-HB1536	GT-HS1532	12"	370	300	22	479	12 / 48 pcs



- Primarily used to file circular openings or concave surfaces
- All 4, 5, 6, 10, 12" files are single-cut
- 14" bastard file is double-cut
- Tapered slightly towards point
- Safe point on round files



ROUND FILES

KIKIR BULAT

ITEM CODE		SIZE	1 (mm)	2 (mm)	3 (mm)	WEIGHT (gr)	QTY / BOX INNER/MASTER
Bastard - Cut	Smooth - Cut						
GT-RB1541	GT-RS1537	6"	195	150	4	59	24 / 288 pcs
GT-RB1542	GT-RS1538	8"	247	200	5	96	24 / 192 pcs
GT-RB1543	GT-RS1539	10"	300	250	6	160	12 / 120 pcs
GT-RB1544	GT-RS1540	12"	370	300	8	292	12 / 96 pcs

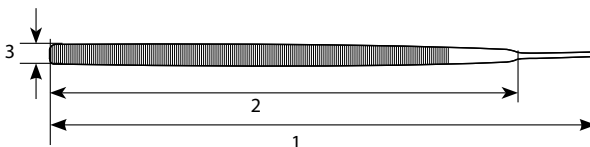

EXTRA SLIM TAPER SAW FILES

EXTRA SLIM TAPER SAW FILES 4"

SIZE	SIZE	1 (mm)	2 (mm)	3 (mm)	WEIGHT (gr)	QTY / BOX INNER/MASTER
GT-ST1928	4"	137	102	4	10	24 / 480 pcs

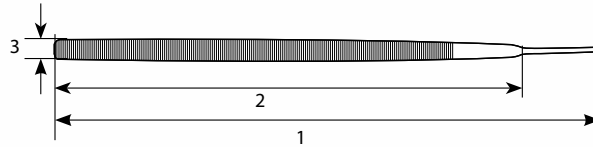

- Fully heat treated
- Edges set and cut for filling gullets between saw teeth
- Tapered slightly towards point



DOUBLE EXTRA SLIM TAPER SAW FILES

DOUBLE EXTRA SLIM TAPER SAW FILES 4"

SIZE	SIZE	1 (mm)	2 (mm)	3 (mm)	WEIGHT (gr)	QTY / BOX INNER/MASTER
GT-ST1929	4"	137	102	3	7.5	24 / 480 pcs

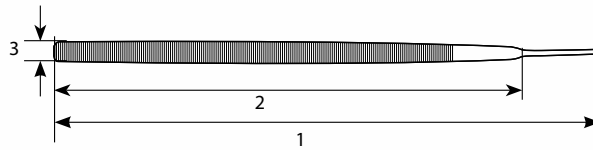

- Fully heat treated
- Edges set and cut for filling gullets between sa teeth
- Tapered slightly towards point



FILES SET 4 PCS

KIKIR SET 4 PCS

ITEM CODE	SIZE	CONTENT	WEIGHT (gr)	QTY / BOX INNER/MASTER
GT-FS1846	6"	Flat (Smooth), Triangle (Smooth), Half Round (Smooth), Round (Smooth)	425	5 / 30 pcs
GT-FS1845	8"	Flat (Bastard), Triangle (Bastard), Half Round (Bastard), Round (Bastard)	1,000	5 / 20 pcs

- Rubber cushion grips
- Set consists of flat, round, triangular, square file
- Essential tools in every service station, garage or building site



AUTOMOTIVE

STORAGE

TRAY

AIR TOOLS

HEX KEY

GENERAL TOOLS

- Rubber cushion grips
- Set consists of flat, round, triangular, square, and half round file
- Essential tools in every service station, garage or building site / Ideal for shaping wood



FILES SET 6 PCS

KIKIR SET 6 PCS

ITEM CODE	SIZE	CONTENT	WEIGHT (gr)	QTY / BOX INNER/MASTER
GT-FS1847	5.5"	Flat, Triangle, Square, Half Round, Round, Warding	2,000	5 / 50 pcs

- Single Blade Pocket knife
- High grade 420 stainless steel
- Perfect for fishing, hiking, camping hunting and most outdoor activities
- Blade's locking and unlocking mechanism for extra safety
- GT-PK1826/27 comes in non reflective black finishing blades

POCKET KNIFE

PISAU LIPAT STAINLESS

ITEM CODE	SIZE	1 (mm)	2 (mm)	WEIGHT (gr)	QTY / BOX INNER/MASTER
GT-PK1783	165 mm	165	20	105	12 / 96 pcs
GT-PK1826	202 mm	202	27	174	12 / 72 pcs
GT-PK1827	260 mm	260	20	292	12 / 72 pcs

GT-PK1783

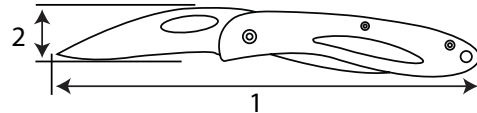

GT-PK1826 / GT-PK1827



- Single Blade Pocket knife
- High grade 420 stainless steel
- Perfect for fishing, hiking, camping hunting and most outdoor activities
- Blade's locking and unlocking mechanism for extra safety
- Build in carabiner

SINGLE KNIFE

PISAU LIPAT

ITEM CODE	SIZE	1 (mm)	2 (mm)	WEIGHT (gr)	QTY / BOX INNER/MASTER
GT-SK1710	189 mm	189	16	63	12 / 144 pcs

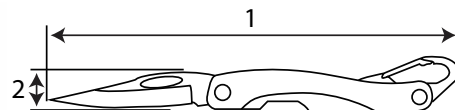

MULTIFUNCTION CLAW HAMMER 15 IN 1

PALU KAMBING LIPAT MULTIFUNGSI 15 IN 1

ITEM CODE	SIZE	1 (mm)	2 (mm)	3 (mm)	4 (mm)	5 (mm)	6 (mm)	WEIGHT (gr)	QTY / BOX INNER/MASTER
GT-MC1785	135 mm	135	88	34	48	65	68	350	6 / 48 pcs

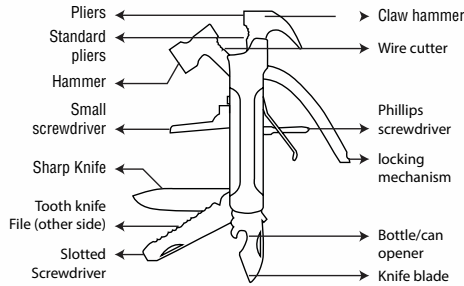
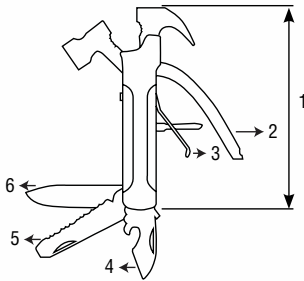

- Also known as the Carpenter tool
- Feature Claw hammer head with nail puller
- High quality stainless steel
- Fits nicely in hands
- Easy access to multiple tools



MULTIFUNCTION POINTED HAMMER 15 IN 1

PALU LANCIP LIPAT MULTIFUNGSI 15 IN 1

ITEM CODE	SIZE	1 (mm)	2 (mm)	3 (mm)	4 (mm)	5 (mm)	6 (mm)	7 (mm)	WEIGHT (gr)	QTY / BOX INNER/MASTER
GT-MP1784	135 mm	135	92	34	66	66	48.5	32	320	6 / 48 pcs

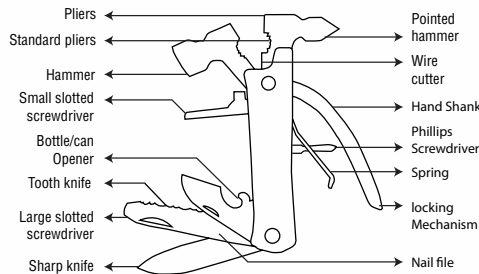
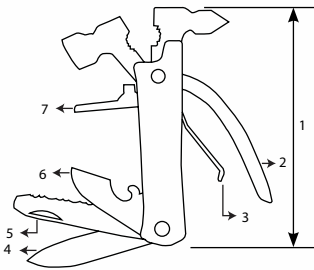

- Also known as the Lifesaver tool
- Pointed hammer is ideal for breaking glass windows in emergency situations
- High quality stainless steel
- Fits nicely in hands
- Easy access to multiple tools



MULTIFUNCTION PLIERS 17 IN 1

TANG LIPAT MULTIFUNGSI 17 IN 1

ITEM CODE	SIZE	1 (mm)	2 (mm)	3 (mm)	4 (mm)	5 (mm)	6 (mm)	7 (mm)	8 (mm)	9 (mm)	WEIGHT (gr)	QTY / BOX INNER/MASTER
GT-MP1786	160 mm	160	65	66	33	31	28	30.6	46	61	250	6 / 48 pcs

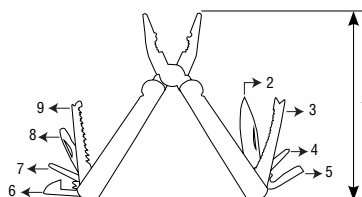
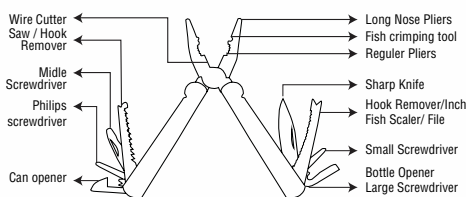

- Ideal for Serious fishermen with additional crimping tool
- Some people call it the Fisherman tool
- Also suitable for other outdoor activities
- High quality stainless steel
- Fits nicely in hands
- Easy access to multiple tools



AUTOMOTIVE

STORAGE

TRAY

AIR TOOLS

HEX KEY

GENERAL TOOLS

- Needle Nose Pliers
- High quality stainless steel
- Fits nicely in hands
- Easy access to multiple tools
- Ideal for fisherman and most outdoor activities
- comes with pouch



MULTIFUNCTION PLIERS 18 IN 1

TANG LIPAT MULTIFUNGSI 18 IN 1

ITEM CODE	SIZE	1 (mm)	2 (mm)	3 (mm)	4 (mm)	5 (mm)	6 (mm)	7 (mm)	8 (mm)	9 (mm)	WEIGHT (gr)	QTY / BOX INNER/MASTER
GT-MP1707	160 mm	160	42	61	33	65	60	43	61	38	292	6 / 48 pcs

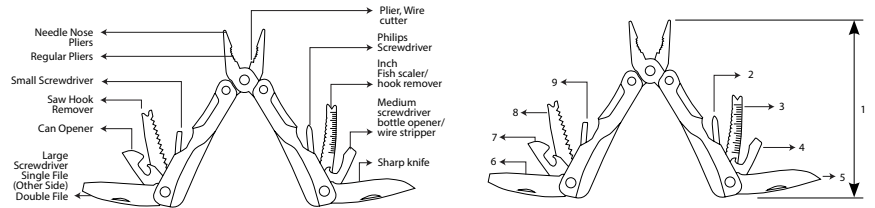

- Most complete Multipurpose pocket tool
- High quality stainless steel
- Comes with pouch
- Ideal for any maintenance work



MULTIFUNCTION PLIERS 25 IN 1

TANG LIPAT MULTIFUNGSI 25 IN 1

ITEM CODE	SIZE	1 (mm)	2 (mm)	3 (mm)	4 (mm)	5 (mm)	6 (mm)	7 (mm)	8 (mm)	9 (mm)	WEIGHT (gr)	QTY / BOX INNER/MASTER
GT-MP1787	165 mm	165	60	34	34	43	31	32	59	62	400	6 / 36 pcs

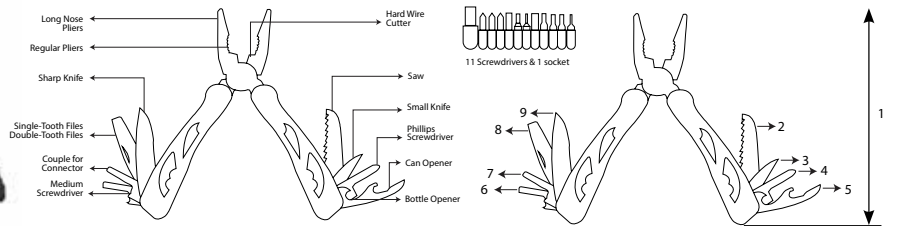

- Feature Big sharp knife
- Some people call it the Handyman tool
- High quality stainless steel
- Fits nicely in hands
- Easy access to multiple tools
- Ideal for fisherman and most outdoor activities
- Comes with pouch



MULTIFUNCTION KNIFE 15 IN 1

PISAU LIPAT MULTIFUNGSI 15 IN 1

ITEM CODE	SIZE	1 (mm)	2 (mm)	3 (mm)	4 (mm)	5 (mm)	6 (mm)	7 (mm)	8 (mm)	9 (mm)	10 (mm)	11 (mm)	12 (mm)	WEIGHT (gr)	QTY / BOX INNER/MASTER
GT-MK1706	85 mm	85	62	62	25	65	62	25	35	35	35	35	35	167	12 / 96 pcs

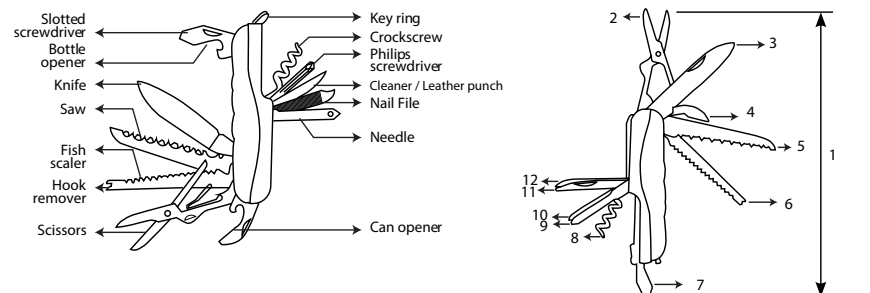

MULTIFUNCTION ADJUSTABLE WRENCH 7 IN 1

KUNCI INGGRIS LIPAT MULTIFUNGSI 7 IN 1

ITEM CODE	SIZE	1 (mm)	2 (mm)	3 (mm)	4 (mm)	5 (mm)	WEIGHT (gr)	QTY / BOX INNER/MASTER
GT-MA1709	6"	150	70	72	70	65	278	12 / 72 pcs

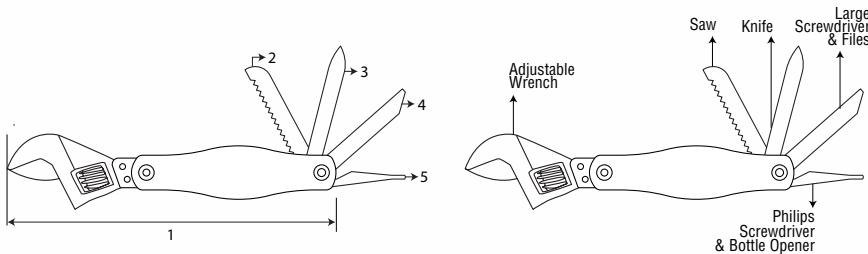

- The "Nut buster" tool
- Ideal for multiple bolt and nuts
- Highly recommended for bikes, cars motorcycle enthusiast
- High quality stainless steel
- Fits nicely in hands
- Easy access to multiple tools
- Comes with pouch



MULTIFUNCTION AXE 7 IN 1

PALU KAPAK LIPAT MULTIFUNGSI 7 IN 1

ITEM CODE	SIZE	1 (mm)	2 (mm)	3 (mm)	WEIGHT (gr)	QTY / BOX INNER/MASTER
GT-MA1828	160 mm	160	44	17	550	6 / 48 pcs

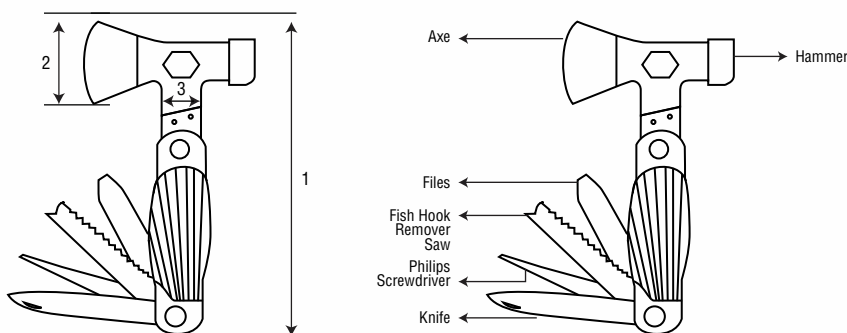

The Bushman tool

- Ideal for survival in the jungle
- Feature a large axe and hammer
- High quality stainless steel
- Fits nicely in hands
- Easy access to multiple tools



MULTIFUNCTION SCISSOR

GUNTING MULTIFUNGSI

ITEM CODE	SIZE	1 (mm)	2 (mm)	3 (mm)	WEIGHT (gr)	QTY / BOX INNER/MASTER
GT-MS1805	7"	180	54	7	133	10 / 100 pcs

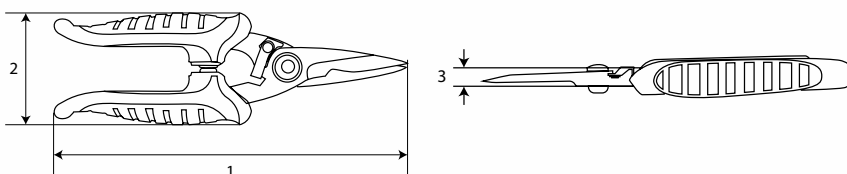

- Made of high-carbon stainless steel, corrosion-resistant
- Dentate cutting blades, extremely sharp, for clean and fast cuts
- The non-slip grip is made of TPE environmentally friendly materials





CLAMP C

TEKIRO are recommended particularly for metalworking and fabrication work where a very high clamping force is needed.



CLAMP C

KLEM C

- Drop Forged steel body
- Twin- Start Acme cold rolled thread
- Swivel head for uneven surfaces
- Ideal for jobs that require high clamping force

ITEM CODE	SIZE	1 (mm)	2 (mm)	3 (mm)	4 (mm)	WEIGHT (gr)	QTY / BOX INNER/MASTER
GT-CC1788	3"	148	10	89	150	560	4 / 24 pcs
GT-CC1789	4"	175	13	88	183	850	4 / 24 pcs
GT-CC1790	5"	150	10	89	150	1,000	2 / 12 pcs
GT-CC1791	6"	253	14	105	250	1,200	2 / 12 pcs
GT-CC1792	8"	400	19	105	403	2,000	2 / 12 pcs

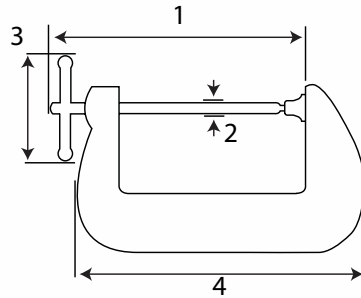

CLAMP C SET 3 PCS

KLEM C SET 3 PCS

- Mini C Clamp set
- Drop Forged steel body
- Twin- Start Acme cold rolled thread
- Swivel head for uneven surfaces
- Ideal for jobs that require high clamping force
- Comes in a set of 3 pieces for small jobs

ITEM CODE	CONTENT	WEIGHT (gr)	QTY / BOX INNER/MASTER
GT-CC1793	1"	580	4 / 24 set
	2"		
	3"		



AUTOMOTIVE

STORAGE

TRAY

AIR TOOLS

HEX KEY

GENERAL TOOLS



HAND RIVETER

A rivet requires a tool that keeps the hat of the rivet firmly pressed against the installation surface, while simultaneously pulling the mandrel away from it. The TEKIRO riveter can solve this job with ease and securely.

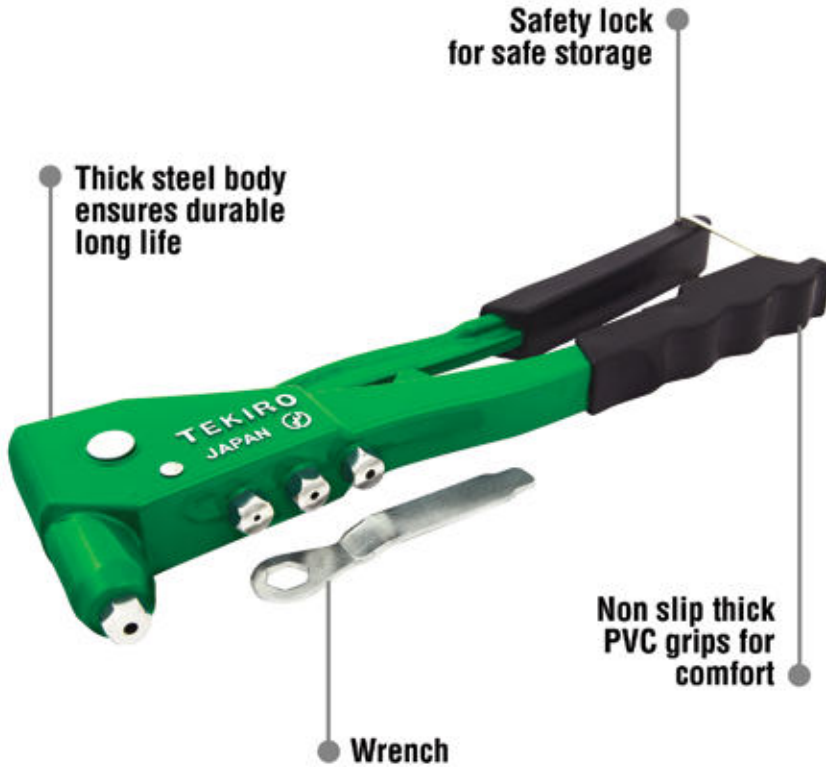

INTERCHANGABLE NOZZLES

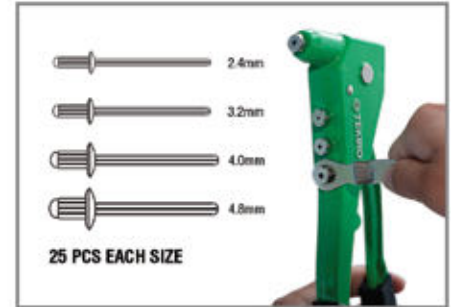

SOLDERING IRON

Whenever you have a soldering job to do, Tekiro Soldering iron is there for you. Heat is transferred evenly to the high quality soldering tip for neat and precise soldering.

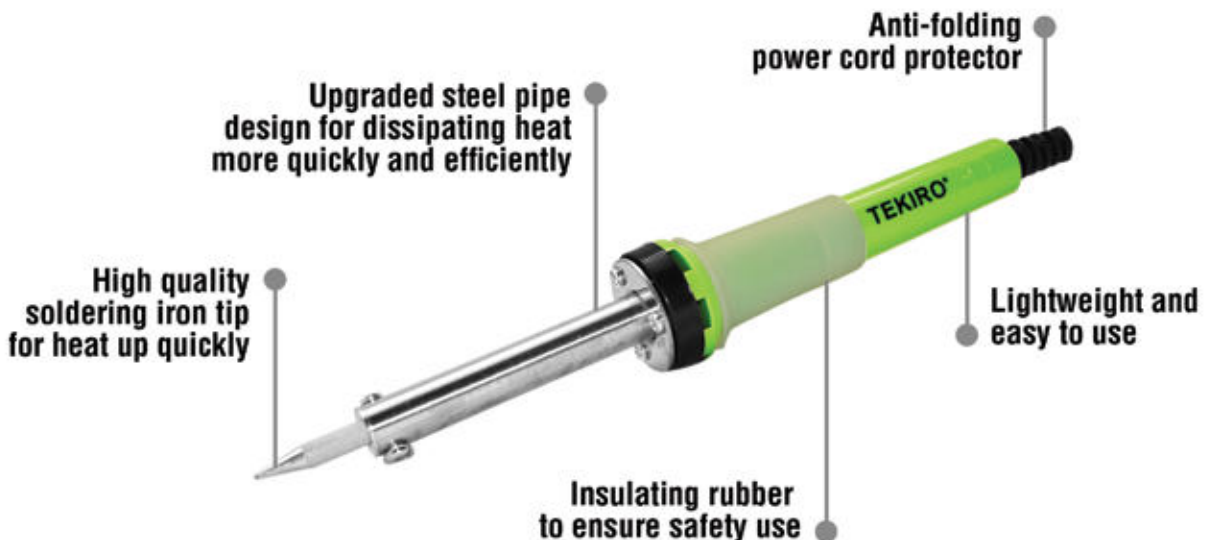

HAND RIVETER

HAND RIVETER

ITEM CODE	SIZE	1 (mm)	2 (mm)	3 (mm)	4 (mm)	WEIGHT (gr)	QTY / BOX INNER/MASTER
GT-HR1231	2.4 - 3.2 - 4.0 - 4.8	265	77	106	16	540	6 / 36 pcs

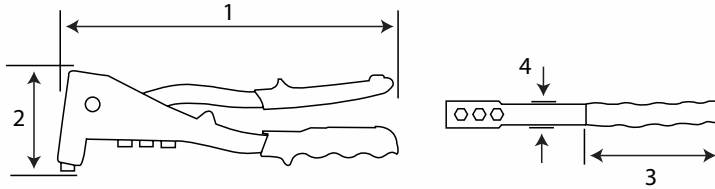

- Used for joining together aluminium and light metals
- For use in auto repair and many other applications
- Heavy duty



HAND RIVETER-1

TANG RIVET-1

ITEM CODE	SIZE	1 (mm)	2 (mm)	3 (mm)	WEIGHT (gr)	QTY / BOX INNER/MASTER
GT-HR1823	2.4 - 3.2 - 4.0 - 4.8	268	79	20	468	6 / 24 pcs

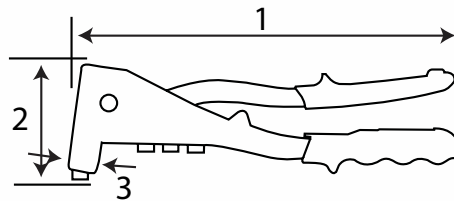

- Used for joining together aluminium and light metals
- For use in auto repair and many other applications



360 DEGREE HAND RIVETER-1

TANG RIVET SWIVEL TIPE 360-1

ITEM CODE	SIZE	1 (mm)	2 (mm)	3 (mm)	WEIGHT (gr)	QTY / BOX INNER/MASTER
GT-HR1824	2.4 - 3.2 - 4.0 - 4.8	280	81	22	660	6 / 24 pcs

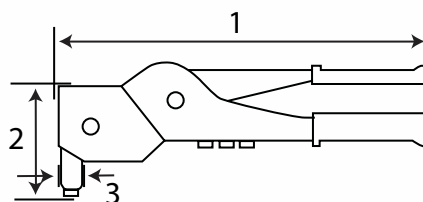

- Used for joining together aluminium and light metals
- For use in auto repair and many other applications
- Swivel head rivet tool with head that swivels 360° to rivet at any angle



- Used to drive heavy metal staples into wood, plastic or masonry
- All steel construction
- Ergonomic handle

STAPLE GUN TRACKER

TEMBAKAN STAPLES STANDAR

ITEM CODE	SIZE	1 (mm)	2 (mm)	3 (mm)	WEIGHT (gr)	QTY / BOX INNER/MASTER
GT-SG1671	4 - 8 mm	75	152	122	483	10 / 40 pcs

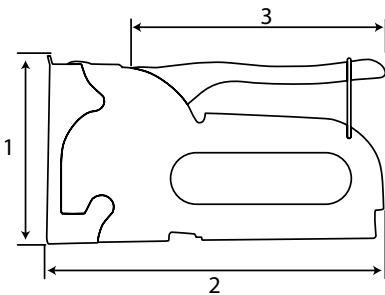

- Used to drive heavy metal staples into wood, plastic or masonry
- All steel construction
- Ergonomic handle
- Suitable for nail, staples and round staples

3 IN 1 STAPLE GUN TACKER

TEMBAKAN STAPLES 3 IN 1

ITEM CODE	SIZE	1 (mm)	2 (mm)	3 (mm)	WEIGHT (gr)	QTY / BOX INNER/MASTER
GT-SG1672	6 - 14 mm	89	154	106	620	10 / 40 pcs

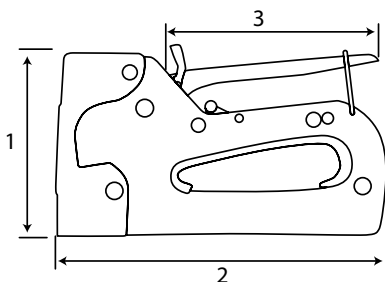

SOLDERING IRON

SOLDER

ITEM CODE	SIZE	1 (mm)	2 (mm)	3 (mm)	4 (mm)	5 (mm)	QTY / BOX INNER/MASTER
EL-SD1771	40 watt	205	95	112	31	1	25 / 50 pcs
EL-SD1772	60 watt	205	95	112	31	1	25 / 50 pcs

- Heat up Quickly
- Cool fast. Upgrade steel-pipe design, dissipating heat more quickly and efficiently
- Ideal for home/DIY/work basic soldering repairing jobs

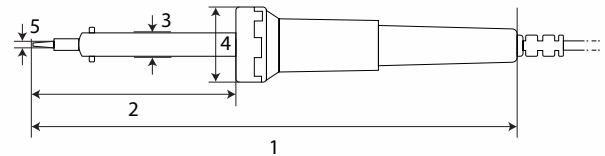

SOLDERING SET

SOLDER SET 3 FUNGSI

ITEM CODE	SIZE	1 (mm)	2 (mm)	3 (mm)	4 (mm)	QTY / BOX INNER/MASTER
EL-SD1773	30 watt	183	67	10	25	10 / 40 pcs

- Heat up Quickly
- Cool fast. Upgrade steel-pipe design, dissipating heat more quickly and efficiently
- Compact size with pointed tip, ideal for home/DIY/work basic soldering repairing jobs
- 3 function for Wood, Plastic and Solder Iron

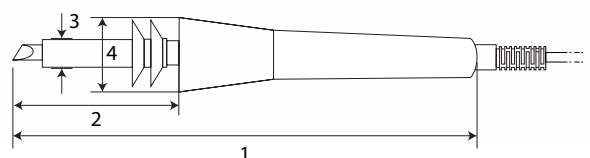

AUTOMOTIVE

STORAGE

TRAY

AIR TOOLS

HEX KEY

GENERAL TOOLS

- Handy all-purpose gluing device
- Effortlessly glues wood, leather, carton, paper, textiles, cork and stone, as well as glass and metal
- Mechanical feed system for sensitive metering and targeted, rapid application
- Safe working thanks to the nozzle with heat shield

GLUE GUN

LEM TEMBAK

ITEM CODE	SIZE	1 (mm)	2 (mm)	WEIGHT (gr)	QTY / BOX INNER/MASTER
GT-GG1723	20 watt	142	137	179	12 / 48 pcs
GT-GG1724	40 watt	172	156	247	6 / 48 pcs

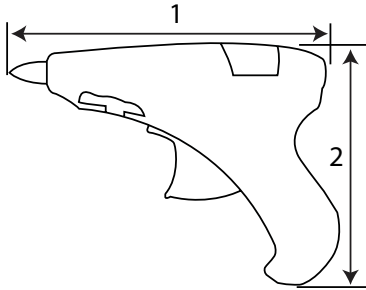

- PORTABLE SIZE:
LED keyring small flashlight is enough to fit in your pocket, so you can take it anywhere
- SPECIAL POWER:
High efficiency and output LED, super bright mini flashlight

FLASLIGHT LED TORCH

SENER LED MINI

ITEM CODE	SIZE	1 (mm)	2 (mm)	WEIGHT (gr)	QTY / BOX INNER/MASTER
GT-FL1825	1.5 V	95	21	73	12 / 144 pcs

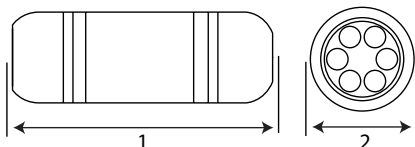





YH CLUTH FIXER B

TEKIRO YH Cluth fixer B uses high-quality material, and suitable for professional use. Holds the flywheel so it's easier to remove or tighten flywheel nut.

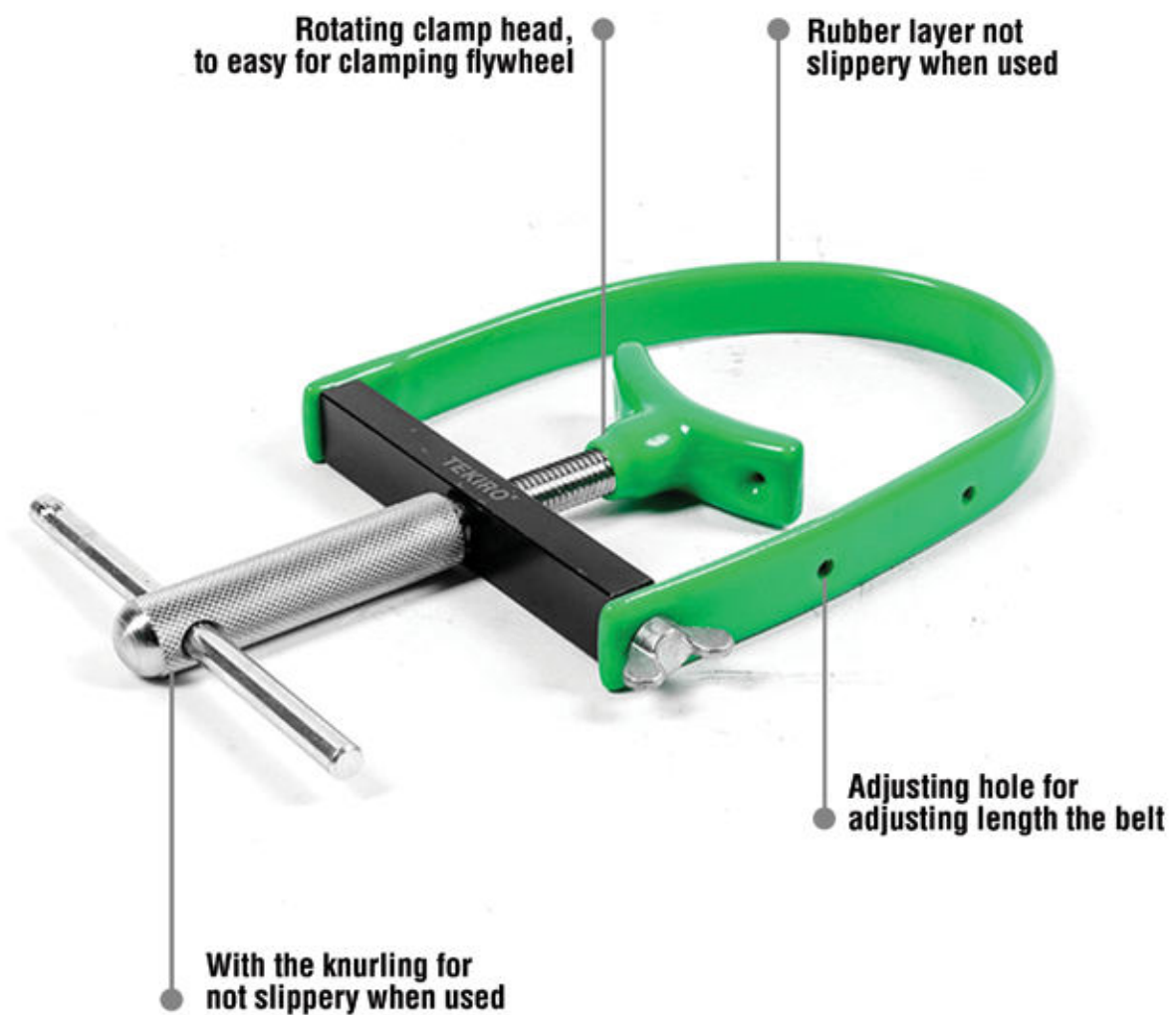

H CLUTCH LOCK NUT SOCKET 1/2" DR.

KUNCI MAHKOTA 1/2" DR.

ITEM CODE	SIZE	1 (mm)	2 (mm)	3 (mm)	WEIGHT (gr)	QTY / BOX INNER/MASTER
SA-TH1308	20 X 24 mm	52	30	26	122	5 / 50 pcs

HOW TO USE

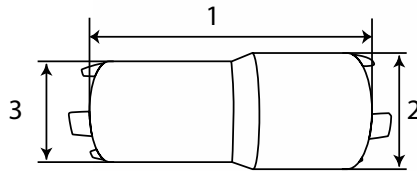
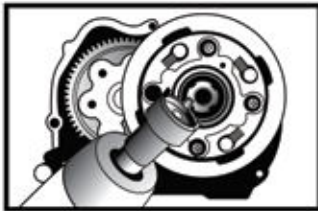

H MAGNETO CLAMP

KUNCI TAHANAN RUMAH KOPLING

ITEM CODE	TYPE	1 (mm)	2 (mm)	3 (mm)	4 (mm)	WEIGHT (gr)	QTY / BOX INNER/MASTER
SA-TH1315	A	83	33	251	14	754	2 / 20 pcs

HOW TO USE

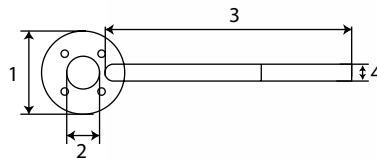
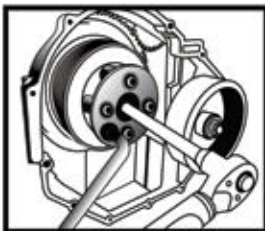

- Design to hold clutch spring bolts securely
- Simple structure and easy to use
- Highly durable and corrosion resistance

H OIL SEAL ASSEMBLER

H OIL SEAL ASSEMBLER

ITEM CODE	TYPE	1 (mm)	2 (mm)	WEIGHT (gr)	QTY / BOX INNER/MASTER
SA-TH1316	A	47	22	174	10 / 100 pcs
SA-TH1317	B	47	30	140	10 / 100 pcs

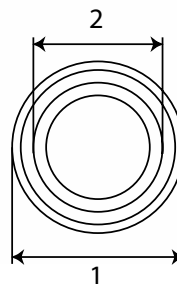

- Design to hold clutch spring bolts securely
- Simple structure and easy to use
- Highly durable and corrosion resistance

H OIL SEAL SLEEVE

H OIL SEAL SLEEVE

ITEM CODE	SIZE	1 (mm)	2 (mm)	3 (mm)	WEIGHT (gr)	QTY / BOX INNER/MASTER
SA-TH1318	60 x 80 mm	60	80	60	827	2 / 20 pcs

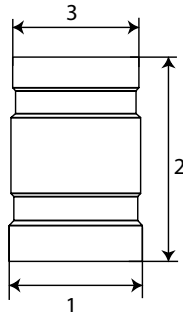

- Design for adjusting streeting stem lock nut
- Simple structure for easy using
- Highly durable and corrossing resistance

H GEAR WHEEL CLAMP

ALAT PENAHAN GEAR

ITEM CODE	TYPE	1 (mm)	2 (mm)	3 (mm)	4 (mm)	WEIGHT (gr)	QTY / BOX INNER/MASTER
SA-TH1319	A	2	9	56	2	13	25 / 250 pcs
SA-TH1320	B	2	9	43	2	8	25 / 250 pcs

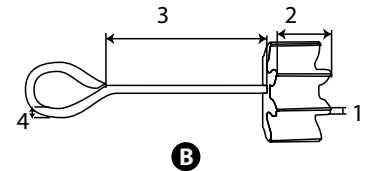
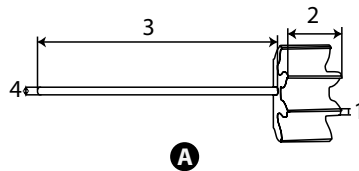
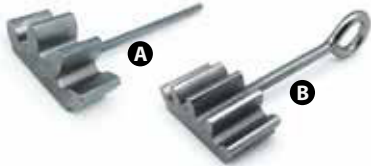

- Removing carbon deposits
- Highly durable
- Easy to use

H VALVE SEAT CUTTER HOLDER

GAGANG ASAHLUBANG KLEP

ITEM CODE	SIZE	1 (mm)	2 (mm)	3 (mm)	WEIGHT (gr)	QTY / BOX INNER/MASTER
SA-TH1330	5 mm	153	152	5	103	10 / 80 pcs
SA-TH1327	5.5 mm	153	152	6	103	10 / 80 pcs

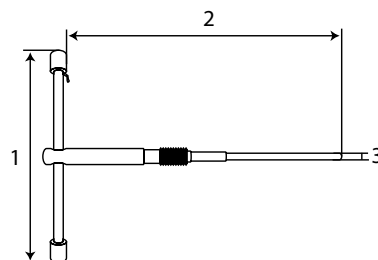

H VALVE SEAT CUTTER (45 DEGREE IN)

MATA ASAH LUBANG KLEP TIPE 45 DERAJAT

- Clean carbon deposits
- Highly durable
- Easy to use

ITEM CODE	SIZE	1 (mm)	2 (mm)	WEIGHT (gr)	QTY / BOX INNER/MASTER
SA-TH1328	24.5 mm	25	8	41	25 / 250 pcs
SA-TH1329	29 mm	29	8	57	25 / 250 pcs

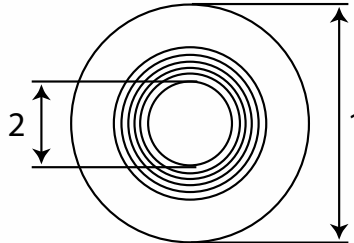

H SOCKET DRIVEN PULLEY NUT

KUNCI SOCKET PULLEY

ITEM CODE	SIZE	1 (mm)	2 (mm)	3 (mm)	WEIGHT (gr)	QTY / BOX INNER/MASTER
SA-TH1335	39 X 41 mm	51	41	42	394	10 / 50 pcs

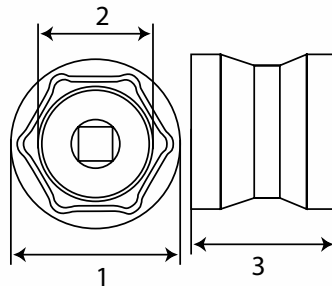

YH CLUTCH FIXER B

TAHANAN KOPLING

ITEM CODE	SIZE	1 (mm)	2 (mm)	3 (mm)	4 (mm)	5 (mm)	6 (mm)	WEIGHT (gr)	QTY / BOX INNER/MASTER
SA-YH1313	161 X 125 mm	135	161	125	11	18	8	656	1 / 36 pcs

HOW TO USE

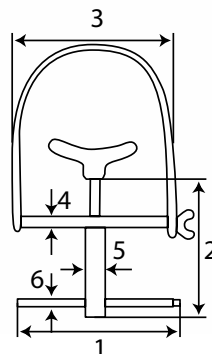

- Design for removing A.C Magnetor rotor
- Simple structure for easy using
- Highly durable and corrosion resistance

MAGNETO REMOVER / DETACHER CP

MAGNETO REMOVER / DETACHER CP

ITEM CODE	SIZE	1 (mm)	2 (mm)	3 (mm)	4 (mm)	5 (mm)	6 (mm)	WEIGHT (gr)	QTY / BOX INNER/MASTER
SA-YH1326	69 mm	69	11	96	14	19	76	491	10 / 20 pcs

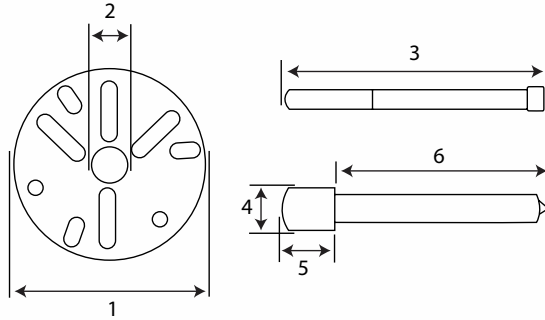

- Highly durable
- Easy to use
- Corrosion resistance

VALVE ADJUST WRENCH

KUNCI STEL KLEP

ITEM CODE	TYPE	1 (mm)	2 (mm)	3 (mm)	4 (mm)	5 (mm)	WEIGHT (gr)	QTY / BOX INNER/MASTER
SA-YH1367		129	12	4	13	3	29	25 / 250 pcs

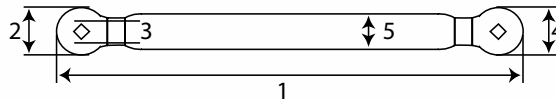



INSULATION SCREWDRIVER

The job isn't finished until everything is tightened down. Precision insulated tools fit and rip the fastener properly to apply maximum torque without damage to the head. The high-quality material blades minimize wear. The last thing you want is to have your driver slip out of the screw head and possibly contact a nearby conductor. TEKIRO offers multiple sizes for insulation screw driver. All certified to 1000 Volt ac and 1500 Volt dc.

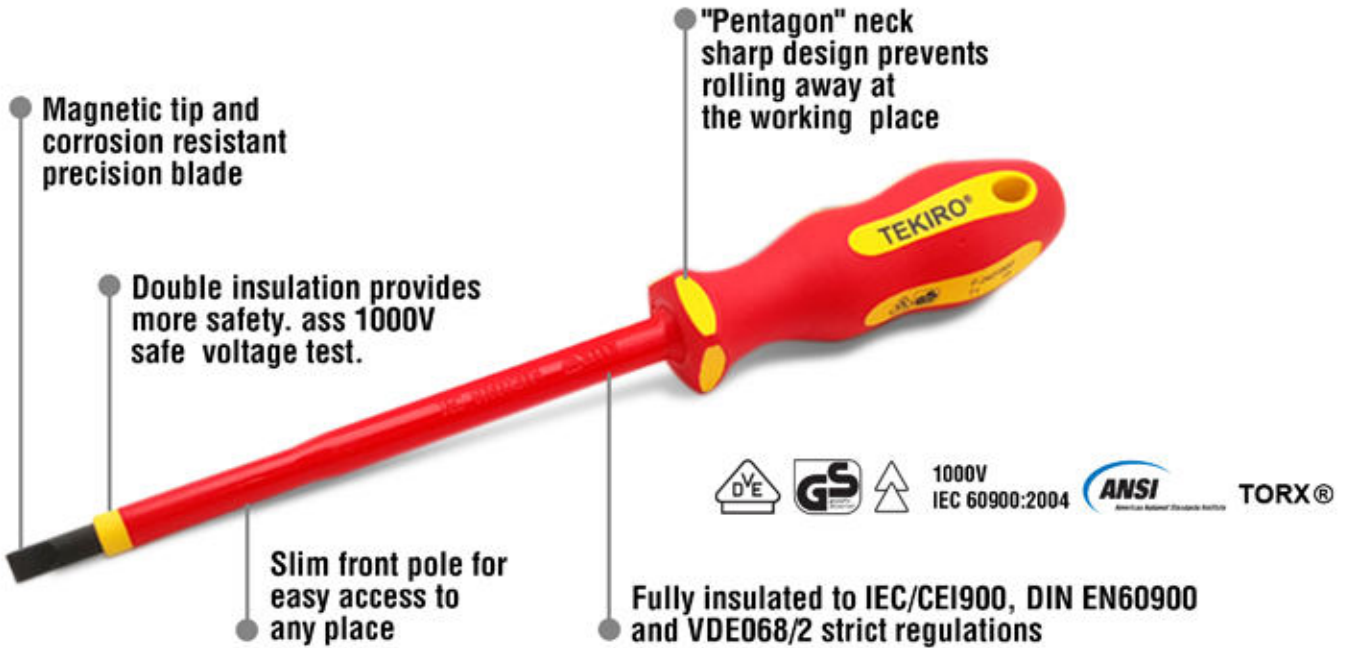

The front end of the screw driver rod is 33% narrow, suitable for narrow spaces such as electric boxes

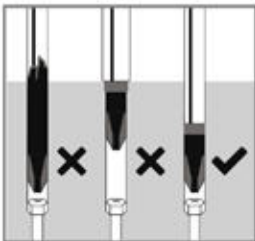

Insulated slim blade can easily reach the screws located in the deep and narrow areas, eliminating the interference caused by the regular insulated sheath

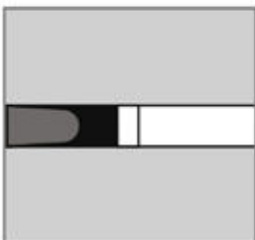

The diameter of its insulated sheath designed to perfectly match that of the blade.



Ergonomics And soft material handle provides high torsion and erases the physical stresses of screw driving.

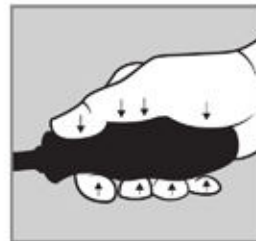

The handle was designed according to different hands holding, it can disperse the pressure evenly and reduce the ache when the application of force.



PP and TPV materials of the handle avoid slipperily and provide resistance to chemical, oil and most solvents. The handle design also can generate high torque coefficient.

INSULATION SCREWDRIVER

OBENG LISTRIK

ITEM CODE	SIZE	1 (mm)	2 (mm)	3 (mm)	4 (mm)	5 (mm)	Weight (gr)	QTY / BOX INNER/MASTER
SD-IS1473	PH0 X 60 mm (3)	130	61	20	5	17	20	12 / 600 pcs
SD-IS1474	PH1 X 80 mm (4.5)	180	80	27	6	24	59	12 / 240 pcs
SD-IS1475	PH2 X 100 mm (6)	210	100	31	9	28	92	12 / 180 pcs
SD-IS1476	PH3 X 150 mm (8)	272	150	35	12	31	163	6 / 120 pcs
SD-IS1477	2.5 X 75 mm (-)	146	76	20	4	17	20	12 / 600 pcs
SD-IS1478	3 X 100 mm (-)	170	101	22	6	17	24	12 / 600 pcs
SD-IS1479	4 X 100 mm (-)	200	100	27	7	25	58	12 / 240 pcs
SD-IS1480	5.5 X 125 mm (-)	225	126	27	9	25	77	12 / 240 pcs
SD-IS1481	6.5 X 150 mm (-)	260	150	31	11	27	112	12 / 180 pcs
SD-IS1482	8 X 175 mm (-)	297	175	30	12	30	176	6 / 120 pcs



- 1000V VDE certified is approved to ensure user safety
- Fully insulated to IEC/CEI900, DIN EN60900 and VDE068/2 strict regulations
- Reach DIN ISO/ ASME standard
- Ergonomic bi-component handles
- Magnetic tip and corrosion resistant precision blade
- Ergonomically designed impact resistant handle with non-slip grip for comfort, maximum torque transfer and roll resistance

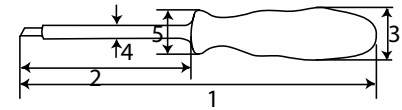

INSULATION SCREWDRIVER SET 4 PCS

OBENG LISTRIK SET 4 PCS

SIZE	CONTENT	Weight (gr)	QTY / BOX INNER/MASTER
4 pcs	2 pcs (+) #PH1 X 80 mm	300	4 / 16 set
	(+) #PH2 X 100 mm		
	2 pcs (-) 3 X 100 mm		
	(-) 5.5 X 125 mm		



- 1000V VDE certified is approved to ensure user safety
- Fully insulated to IEC/CEI900, DIN EN60900 and VDE068/2 strict regulations
- Reach DIN ISO/ ASME standard
- Ergonomic bi-component handles
- Magnetic tip and corrosion resistant precision blade
- Ergonomically designed impact resistant handle with non-slip grip for comfort, maximum torque transfer and roll resistance

ITEM CODE	SIZE
SD-IS14488	4 pcs

INSULATION SCREWDRIVER SET 8 PCS

OBENG LISTRIK SET 8 PCS

ITEM CODE	SIZE
SD-IS1489	8 PCS

- 1000V VDE certified is approved to ensure user safety
- Fully insulated to IEC/CEI900, DIN EN60900 and VDE068/2 strict regulations
- Reach DIN ISO/ ASME standard
- Ergonomic bi-component handles
- Magnetic tip and corrosion resistant precision blade
- Ergonomically designed impact resistant handle with non-slip grip for comfort, maximum torque transfer and roll resistance

SIZE	CONTENT	Weight (gr)	QTY / BOX INNER/MASTER
8 pcs	2 pcs (+) #PH0 X 60 mm	580	3 / 12 set
	(+) #PH1 X 80 mm		
	(+) #PH2 X 100 mm		
	4 pcs (-) 2.5 X 75 mm		
	(-) 4 X 100 mm		
	(-) 5.5 X 125 mm		
	(-) 6.5 X 155 mm		
	1 pc AC Tester		



- Easy to use
- Indicator lamp for easy check

AC TESTER SCREWDRIVER

TESPEN AC

ITEM CODE	SIZE	1 (mm)	2 (mm)	3 (mm)	4 (mm)	5 (mm)	Weight (gr)	QTY / BOX INNER/MASTER
EL-AT1497	105-250 V	142	70	13	3	13	46	24 / 144 pcs

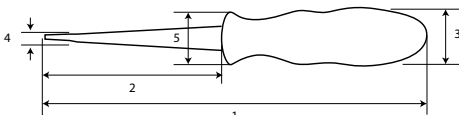

INSULATION LINESMAN PLIERS

TEKIRO Insulation Pliers are 1000V rated and VDE certified for safety on the job. The multi-colour, sleek design with small thumb guards make for easy handling and storage. The durable, moulded Fully insulated to IEC/CEI900, DIN EN60900 and VDE0680 strict regulations for insulated tools. Insulated for protection when working near energized sources

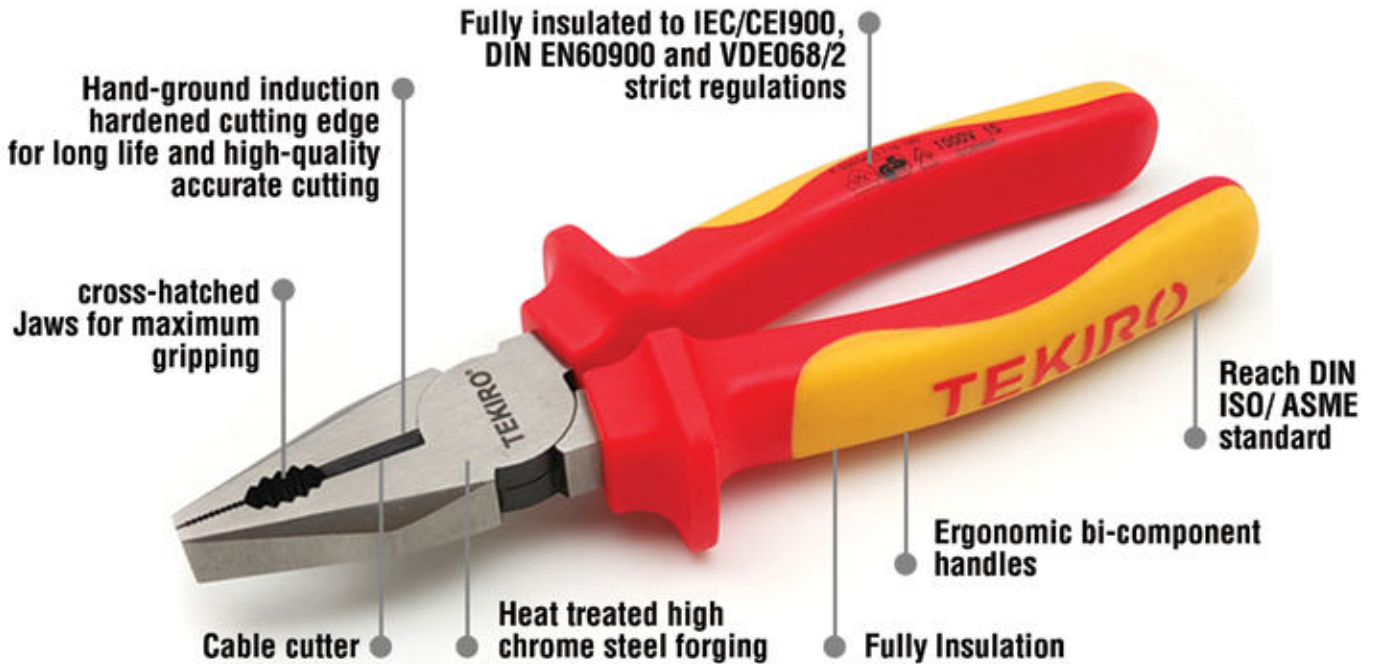

SAFE AND RELIABLE

The power side cutters with VDE insulation ensure safe working up to 1,000 volts. The integrated protective insulation helps to work safely even in areas that are difficult to access.



HANDY GRIPS

The practical anti-slip protection makes it possible to hold the cutters safely. The ergonomic shape also ensures a more effective power transmission.



PRECISE CUTTING FUNCTION

A cutting function is integrated for efficient cutting of cables and wires





INSULATION LONG NOSE PLIERS



INSULATION DIAGONAL PLIERS

Wires need cutting. Cables need pulling. Knockouts need twisting. Sometimes things just need holding. **TEKIRO** insulation Long nose pliers and cutters give you a range of options when the job requires jaws with bite.

INSULATION DIAGONAL PLIERS LONG

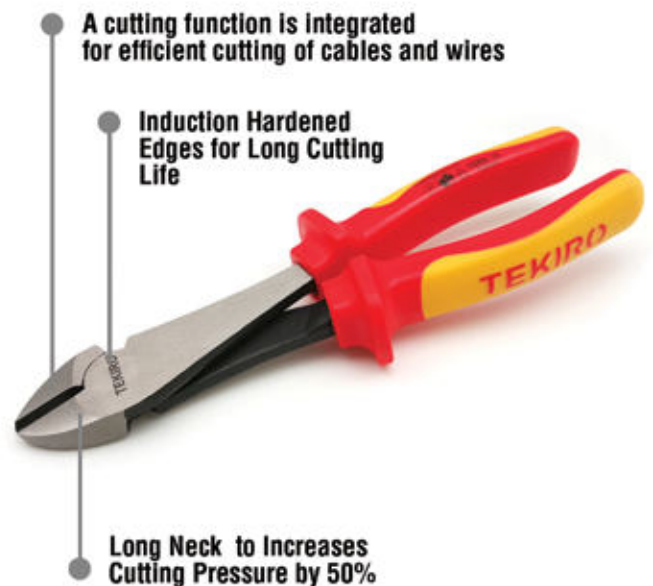

WWW.TEKIRO.COM

INSULATION LINESMAN PLIERS

TANG KOMBINASI LISTRIK

ITEM CODE	SIZE	1 (mm)	2 (mm)	3 (mm)	4 (mm)	5 (mm)	6 (mm)	WEIGHT (gr)	QTY / BOX INNER/MASTER
EL-IL1491	7"	186	27	126	11	37	21	281	12 / 48 pcs
EL-IL1492	8"	210	30	142	12	41	23	392	12 / 48 pcs



- 1000V VDE certified is approved to ensure user safety
- Fully insulated to IEC/CEI900, DIN EN60900 and VDE0680 strict regulations
- Reach DIN ISO/ ASME standard
- Ergonomic bi-component handles
- Heat treated high chrome steel forging for long life and durability
- Edge interlocking joint assembly
- Hand ground induction hardened cutting edge for long life and high quality accurate cutting

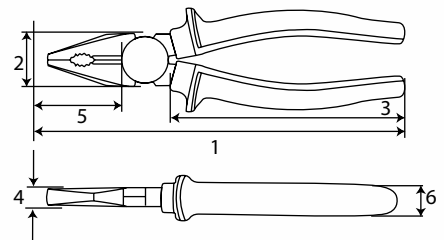

INSULATION LONG NOSE PLIERS

TANG LANCIP LISTRIK

ITEM CODE	SIZE	1 (mm)	2 (mm)	3 (mm)	4 (mm)	5 (mm)	6 (mm)	WEIGHT (gr)	QTY / BOX INNER/MASTER
EL-LN1493	6"	161	19	95	10	39	20	159	12 / 48 pcs
EL-LN1494	8"	231	20	144	11	60	22	254	12 / 48 pcs

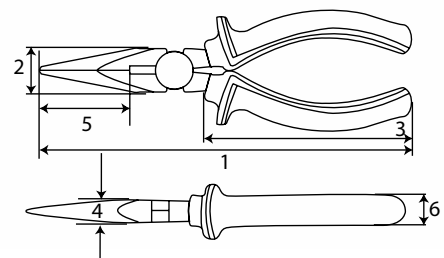

- 1000V VDE certified is approved to ensure user safety
- Fully insulated to IEC/CEI900, DIN EN60900 and VDE0680 strict regulations
- Reach DIN ISO/ ASME standard
- Ergonomic bi-component handles
- Heat treated high chrome steel forging for long life and durability
- Edge interlocking joint assembly
- Hand ground induction hardened cutting edge for long life and high quality accurate cutting

- 1000V VDE certified is approved to ensure user safety
- Fully insulated to IEC/CEI900, DIN EN60900 and VDE0680 strict regulations
- Reach DIN ISO/ ASME standard
- Ergonomic bi-component handles
- Heat treated high chrome steel forging for long life and durability
- Edge interlocking joint assembly
- Hand ground induction hardened cutting edge for long life and high quality accurate cutting

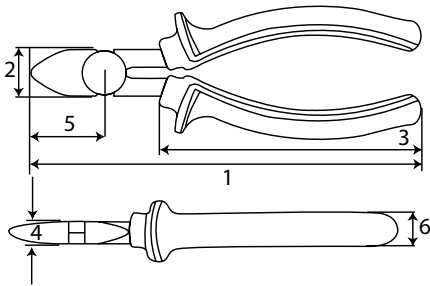

INSULATION DIAGONAL PLIERS

TANG POTONG LISTRIK

ITEM CODE	SIZE	1 (mm)	2 (mm)	3 (mm)	4 (mm)	5 (mm)	6 (mm)	WEIGHT (gr)	QTY / BOX INNER/MASTER
EL-ID1495	6"	166	22	125	10	21	21	228	12 / 48 pcs



- 1000V VDE certified is approved to ensure user safety
- Fully insulated to IEC/CEI900, DIN EN60900 and VDE0680 strict regulations
- Reach DIN ISO/ ASME standard
- Ergonomic bi-component handles
- Heat treated high chrome steel forging for long life and durability
- Edge interlocking joint assembly
- Hand ground induction hardened cutting edge for long life and high quality accurate cutting

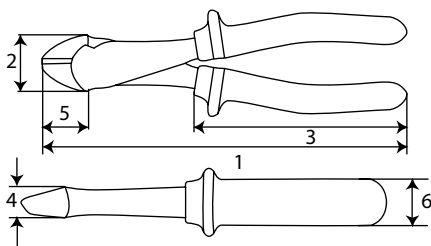

INSULATION DIAGONAL PLIERS LONG

TANG POTONG PANJANG LISTRIK

ITEM CODE	SIZE	1 (mm)	2 (mm)	3 (mm)	4 (mm)	5 (mm)	6 (mm)	WEIGHT (gr)	QTY / BOX INNER/MASTER
EL-ID1496	8"	205	28	114	11	21	22	284	12 / 48 pcs



INSULATION ADJUSTABLE WRENCH

TEKIRO insulated adjustable wrenches are made for professional electrical users, moulded Fully insulated to IEC/CEI900, DIN EN60900 and VDE0680 strict regulations for insulated tools. Insulated for protection when working near energized sources with the VDE certified for safety on the job, the jaw design help reduces slippage. **TEKIRO** use high-quality material for durable use

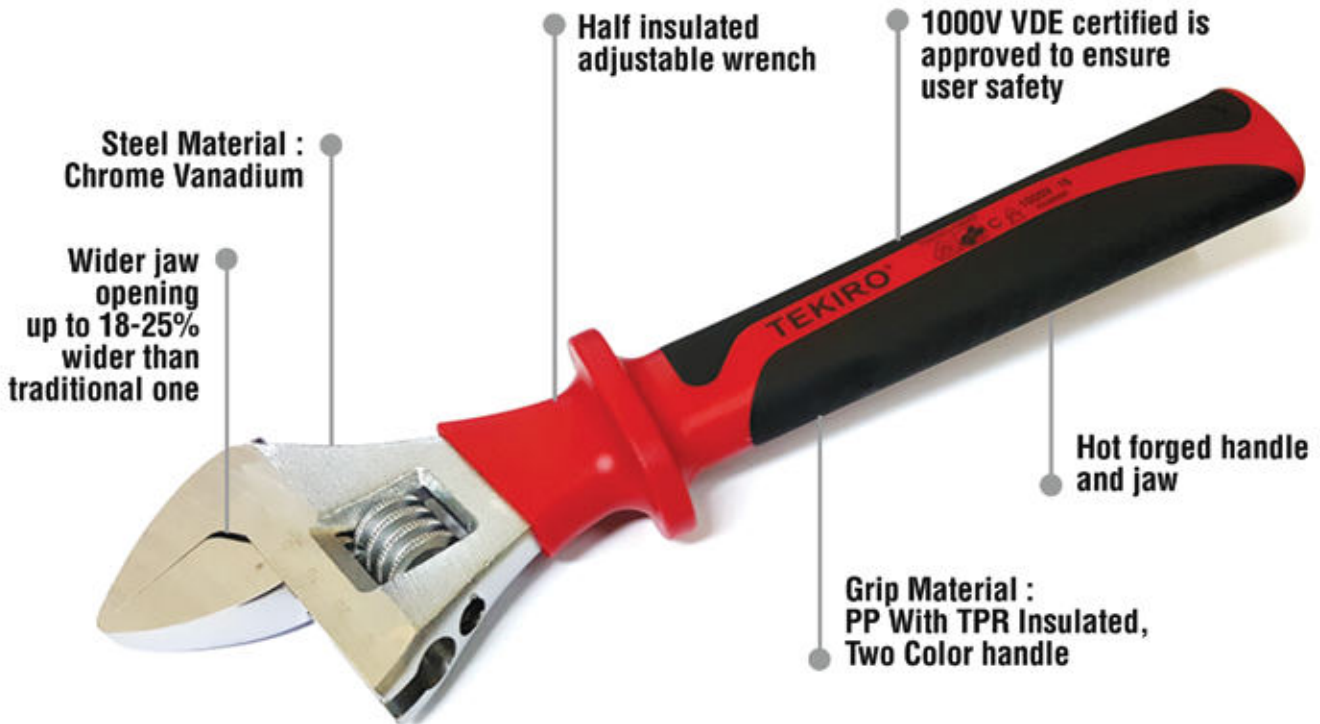

SAFE AND RELIABLE

The power side cutters with VDE insulation ensure safe working up to 1,000 volts. The integrated protective insulation helps to work safely even in areas that are difficult to access.



HANDLE STOPS

Special features for safety for users, to prevent electric shock



COMFORT HANDLE

The practical anti-slip protection makes it possible to hold the handle safely and comforts. The ergonomic shape also ensures a more effective power transmission



- Half insulated adjustable wrench
- Handle stop prevents user electric shock.
- Thicker handle provides comfortable hand fit.

INSULATION ADJUSTABLE WRENCH

KUNCI INGGRIIS LISTRIK

ITEM CODE	SIZE	1 (mm)	2 (mm)	3 (mm)	4 (mm)	5 (mm)	6 (mm)	Weight (gr)	QTY / BOX INNER/MASTER
EL-AW1498	10"	260	22	16	72	32	35	482	6 / 24 pcs
EL-AW1499	12"	309	24	20	81	37	39	710	6 / 24 pcs

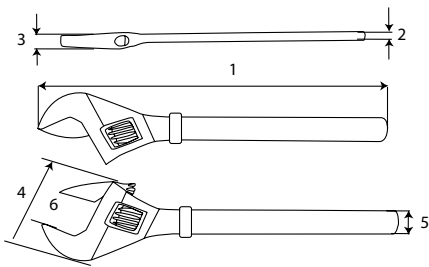

- Protection against spark discharge
- Straight cable knife
- Ergonomic grip with protective cap

INSULATION CUTTER

PISAU ELEKTRIK

ITEM CODE	SIZE	1 (mm)	2 (mm)	3 (mm)	4 (mm)	5 (mm)	Weight (gr)	QTY / BOX INNER/MASTER
GT-IC1485	17 mm	196	157	36	17	19	110	20 / 60 pcs

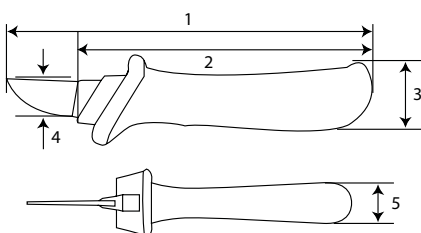



WELDING

HEAVY DUTY WELDING REGULATOR

Recommended for applications that require a constant delivery of pressure. This regulator provides superior characteristics for applications where a change in delivery pressure would affect performance characteristics of work or test result.

HEAVY DUTY WELDING REGULATOR ACETYLENE



HEAVY DUTY CUTTING TORCH

Each torch handle is designed and built to withstand rugged job site conditions.

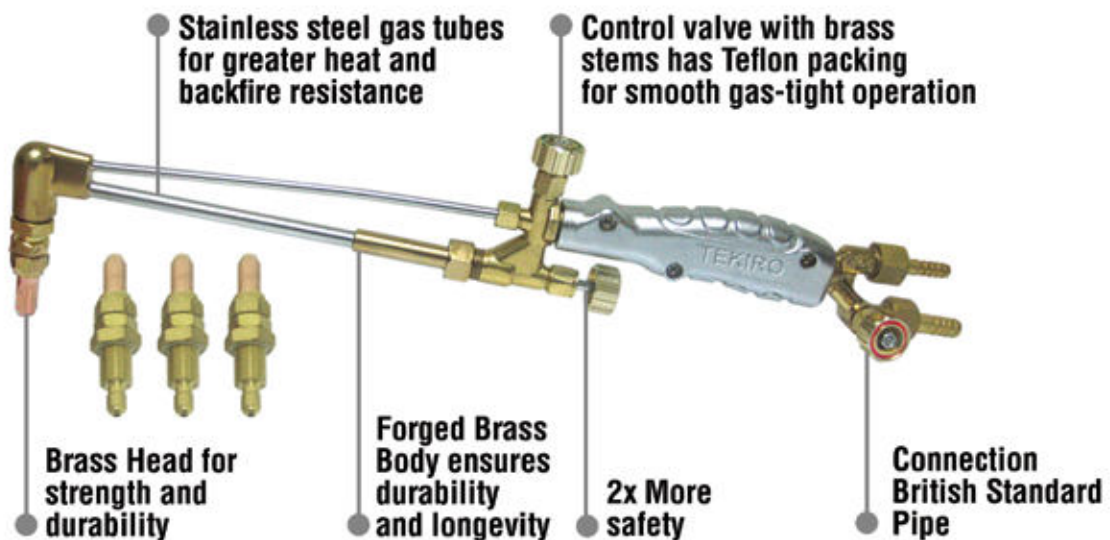

HEAVY DUTY WELDING REGULATOR ACETYLENE

REGULATOR ACETYLENE

ITEM CODE	SIZE	1 (mm)	2 (mm)	3 (mm)	4 (mm)	WEIGHT (gr)	QTY / BOX INNER/MASTER
WE-RA1739	40 Bar	60	60	30	30	1,200	1 / 10 pcs

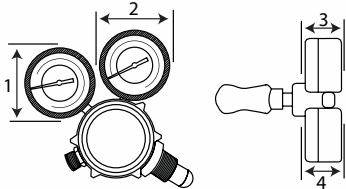

SPECIFICATION

Applicable Gas	: Acetylene
Inlet Pressure	: Max. 25kgf/cm ²
Delivery Pressure	: 0.2-1.5kgf/cm ²
Standard Flow Rate	: 5Nm ³ /H (at 0.5kgf/cm ²)
Maximum Flow Rate	: 11Nm ³ /H
Inlet Pressure Gauge	: 0-25kgf/cm ² (350 lb/in ²)
Delivery Pressure Gauge	: 0-3kgf/cm ² (40 lb/in ²)
Inlet Connection	: BSP (British Standard Pipe)
Outlet Connection	: M16xP1.5(L) + Hose Nipple

- **DUAL PRESSURE GAUGE:** The regulator is equipped with an easy-to-use dual pressure gauge made of high quality materials
- The measurement range is from 0.01 MPa to 0.15 MPa



HEAVY DUTY WELDING REGULATOR OXYGEN

REGULATOR OKSIGEN

ITEM CODE	SIZE	1 (mm)	2 (mm)	WEIGHT (gr)	QTY / BOX INNER/MASTER
WE-RO1740	3500 LBF/IN ²	62	28	1,200	1 / 10 pcs

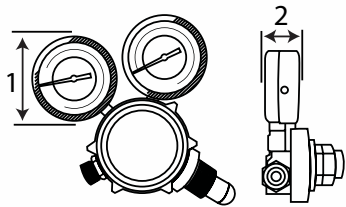

SPECIFICATION

Applicable Gas	: Oxygen
Inlet Pressure	: Max. 165kgf/cm ²
Delivery Pressure	: 2-15kgf/cm ²
Standard Flow Rate	: 35Nm ³ /H (at 5kgf/cm ²)
Maximum Flow Rate	: 100Nm ³ /H
Inlet Pressure Gauge	: 0-250kgf/cm ² (3500 lb/in ²)
Delivery Pressure Gauge	: 0-25kgf/cm ² (350 lb/in ²)
Inlet Connection	: BSP (British Standard Pipe)
Outlet Connection	: M16xP1.5(L) + Hose Nipple

- **DUAL PRESSURE GAUGE:** The regulator is equipped with an easy-to-use dual pressure gauge made of high quality materials
- The measurement range is from 0.01 MPa to 0.15 MPa



HEAVY DUTY WELDING REGULATOR LPG

REGULATOR LPG

ITEM CODE	SIZE	1 (mm)	2 (mm)	3 (mm)	4 (mm)	WEIGHT (gr)	QTY / BOX INNER/MASTER
WE-RL1741	350 LBF/IN ²	60	60	30	30	1,200	1 / 10 pcs

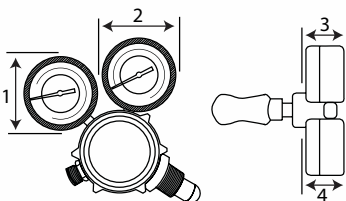

SPECIFICATION

Applicable Gas	: LPG
Inlet Pressure	: Max. 40kgf/cm ²
Delivery Pressure	: 4kgf/cm ²
Standard Flow Rate	: 1.5Nm ³ /H (at 15kgf/cm ²)
Maximum Flow Rate	: 3Nm ³ /H
Inlet Pressure Gauge	: 50kgf/cm ² (725lb/in ²)
Delivery Pressure Gauge	: 6kgf/cm ² (87lb/in ²)
Inlet Connection	: BSP (British Standard Pipe)
Outlet Connection	: M16xP1.5(L) + Hose Nipple

- **DUAL PRESSURE GAUGE:** The regulator is equipped with an easy-to-use dual pressure gauge made of high quality materials.
- The measurement range is from 0.01 MPa to 0.15 MPa.



HEAVY DUTY CUTTING TORCH TYPE 241

BLENDER POTONG TIPE 241

ITEM CODE	SIZE	1 (mm)	2 (mm)	3 (mm)	4 (mm)	5 (mm)	TIP TYPE	ORIFICE (ømm)	CUTTING THICKNESS (mm)	WORKING GAS PRESSURE (kgf/cm ²)		WEIGHT (gr)	QTY / BOX INNER/MASTER
										OXIGEN	FUEL GAS		
WE-CT1742	455 Bar	465	120	8	10	73	241-1	0.7	1-5	2.5	0.2	1,000	1 / 10 pcs
							241-2	0.9	5-15	3.0	0.2		
							241-3	1.1	15-30	3.5	0.2		

- Material: 100% Copper
- 100% Brand New with high quality.

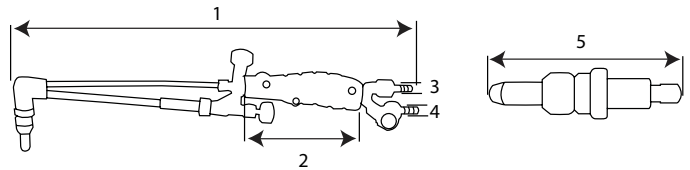

HEAVY DUTY WELDING TORCH TYPE 207

BLENDER LAS TIPE 207

ITEM CODE	SIZE	TIP TYPE	1 (mm)	2 (mm)	3 (mm)	4 (mm)	ORIFICE (ømm)	DEPTH (mm)	WORKING GAS PRESSURE (kg/cm ²)		WEIGHT (gr)	QTY / BOX INNER/MASTER
									OXIGEN	ACETYLENE		
WE-WT1744	250mm	A	240.5	98	149	7.9	0.7	3.3	1.5	0.2-0.5	1,000	1 / 10 pcs
		B			177	7.9	1.0	6.2	2.5	0.2-0.5		
		C			193	8.9	1.3	6.4	3.0	0.2-0.5		
		D			215	8.9	1.5	7.5	3.0	0.2-0.5		

- British Standard Pipe Connection
- 100% Forge Brass Body
- High Precision and safety flow and tip

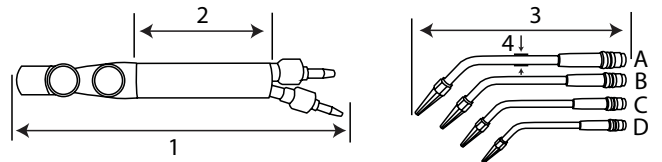

HEAVY DUTY CUTTING TORCH TYPE 825

BLENDER POTONG TIPE 825

ITEM CODE	SIZE	1 (mm)	2 (mm)	3 (mm)	4 (mm)	5 (mm)	TIP TYPE	CUTTING THICKNESS (ømm)	WORKING GAS PRESSURE (kgf/cm ²)		WEIGHT (gr)	QTY / BOX INNER/MASTER	
									OXIGEN	FUEL GAS			
WE-CT1743	Type 825	464	119	8	10	72	55	825-1	1-5	1.5	0.5	850	1 / 10 pcs
								825-2	5-10	1.5	0.5		
								825-3	10-30	2.0	1		
								825-4	30-50	2.5	1		

- British Standard Pipe Connection
- 100% Forge Brass Body
- High Precision and safety flow and tip

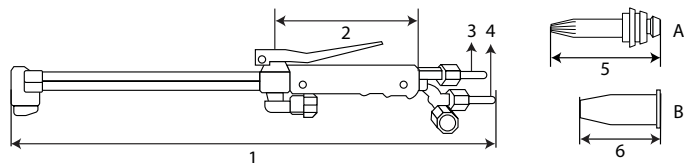

WELDING CABLE

Welding cables used on board, on deck or in an engine room, are exposed to rough weather, oil and mechanical wear. The welding cable supplied by TEKIRO has wear, flame and oil-resistant insulation on a PVC basis. The cable is available in size 16mm, 25mm, 35mm, 50mm, 70mm and 95mm, in standard lengths of 50m, and 100m.



Rugged PVC jacket for Allows free, wide, and seamless adjustment of the required physical properties of this wire such as flexibility, elasticity, and impact resistance

100% Cooper for a good conductor of power transfer

Suitable for various welding machine (16mm, 25mm, 35mm, 70mm, 95mm)

Wire cable more flexible and easy to handle

**Rated up to
600 volts,
-40°C to +85°C**



- 100% Cooper
- More strong and durable

CUTTING TIP TYPE 241 ACETYLENE

MATA BLENDER POTONG ACETYLENE TIPE 241

ITEM CODE	SIZE	1 (mm)	2 (mm)	3 (mm)	WEIGHT (gr)	QTY / BOX INNER/MASTER
WE-CT1763	241-1	71	13	8	67	12 / 144 pcs
WE-CT1765	241-2	71	13	8	67	12 / 144 pcs
WE-CT1767	241-3	71	13	8	67	12 / 144 pcs

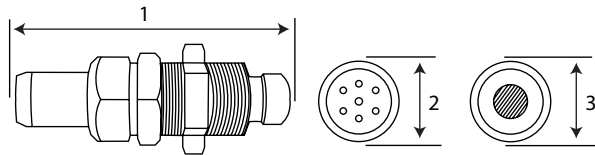

- 100% Cooper
- Strong and durable

CUTTING TIP TYPE 241 LPG

MATA BLENDER POTONG LPG TIPE 241

ITEM CODE	SIZE	1 (mm)	2 (mm)	3 (mm)	4 (mm)	5 (mm)	WEIGHT (gr)	QTY / BOX INNER/MASTER
WE-CT1764	241-1	72	3	10	3	8	67	12 / 144 pcs
WE-CT1766	241-2	72	3	10	3	8	67	12 / 144 pcs
WE-CT1768	241-3	72	3	7	3	8	67	12 / 144 pcs

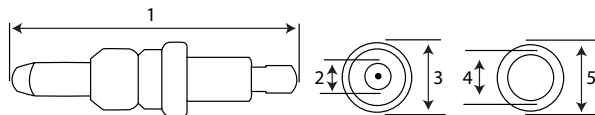

- Highly Flexible while remaining seriously durable
- Copper conductor with P.V.C insulation, (resistant to oils, petrol, diesel, lubes and a range of diluted acids)
- Manufactured in accordance to CE, ROHS, ISO and EN numbers where applicable

HEAVY DUTY WELDING CABLE

KABEL LAS

ITEM CODE	SIZE	1 (mm)	CONDUCTOR CAPACITY (mm cu)	WEIGHT (gr)	QTY / BOX INNER/MASTER
WE-WC1799	16 mm (100 m)	16	448	18,750	1 pcs
WE-WC1800	25 mm (100 m)	25	780	23,010	1 pcs
WE-WC1801	35 mm (100 m)	35	968	32,500	1 pcs
WE-WC1802	50 mm (100 m)	50	1,399	42,000	1 pcs
WE-WC1803	70 mm (100 m)	70	1,824	58,750	1 pcs
WE-WC1903	95 mm (50 m)	95	1,938	37,350	1 pcs

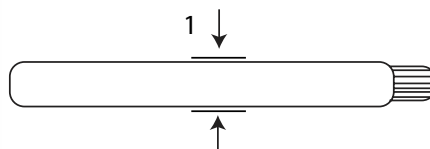



GARDENING TOOLS

TEKIRO has a range of gardening tools which includes Pruning Saw, Pruning Shears and Multifunction Scissors are ideal for gardening hobbyists and professionals. Our ergonomic design combined with quality manufacturing ensure that everyday gardening is easy and enjoyable.

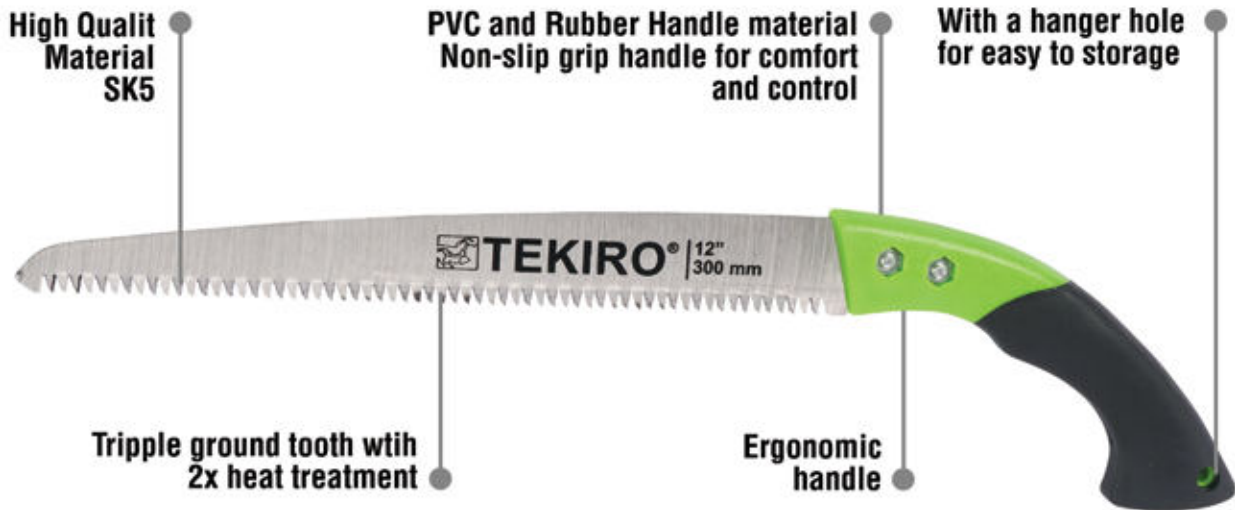

- ERGONOMIC HANDLE**
 The ergonomic handle and slightly angled handle shape and soft handle parts allow the saw to lie comfortably and safely in your hand.
- EFFORT-SAVING SAWING**
 Outstanding ergonomics, high-quality materials (SK5) provide great sawing performance with little effort ensure easy sawing.
- SMOOTH CUT**
 The high quality material, triple teeth saw blade, impulse-hardened teeth cuts branches with precision. Starting a saw cut is considerably easier.



PRUNING SAW

GERGAJI DAHAN

ITEM CODE	SIZE	1 (mm)	2 (mm)	3 (mm)	4 (mm)	5 (mm)	WEIGHT (gr)	QTY / BOX INNER/MASTER
GT-PS1715	12"	476	310	191	21	36	225	10 / 60 pcs

- Comfort & anti slip grip
- Sharp and precise edge
- Can be use for most type of wood
- Quick cut high strength blade
- The blade features super sharp teeth for more aggressive and faster cutting
- Tripple ground tooth

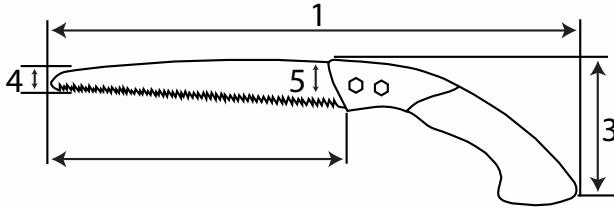

PRUNING SHEAR CURVED

GUNTING DAHAN BENGKOK

ITEM CODE	SIZE	1 (mm)	2 (mm)	3 (mm)	4 (mm)	WEIGHT (gr)	QTY / BOX INNER/MASTER
GD-PS1782	8"	207	52	85	85	269	10 / 60 pcs

- Heavy duty pruning shears with soft grips
- Ideal for pruning bonsai, dead heading, thinning of soft stem branches, shrubs and flower stems
- Curved stainless steel blades hardened and tempered

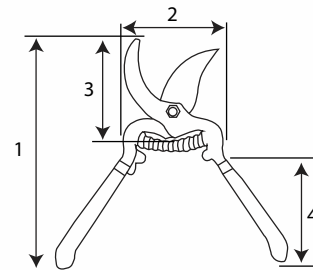
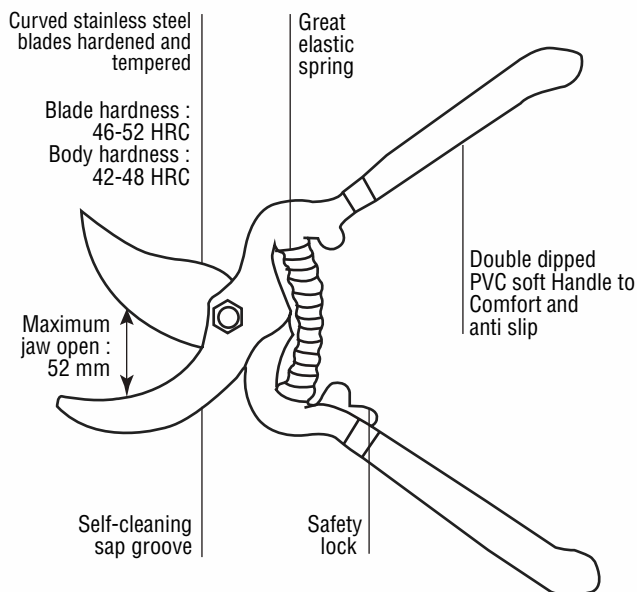

- Heavy duty pruning shears with soft grips
- Ideal for pruning bonsai, dead heading, thinning of soft stem branches, shrubs and flower stems
- Straight stainless steel blades hardened and tempered

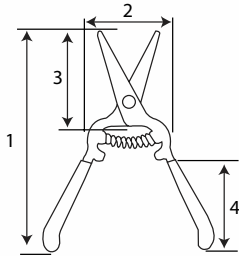

PRUNING SHEAR STRAIGHT

GUNTING DAHAN LURUS

ITEM CODE	SIZE	1 (mm)	2 (mm)	3 (mm)	4 (mm)	WEIGHT (gr)	QTY / BOX INNER/MASTER
GD-PS1780	6"	150	38	65	60	132	10 / 100 pcs
GD-PS1781	8"	202	44	85	77	209	10 / 60 pcs

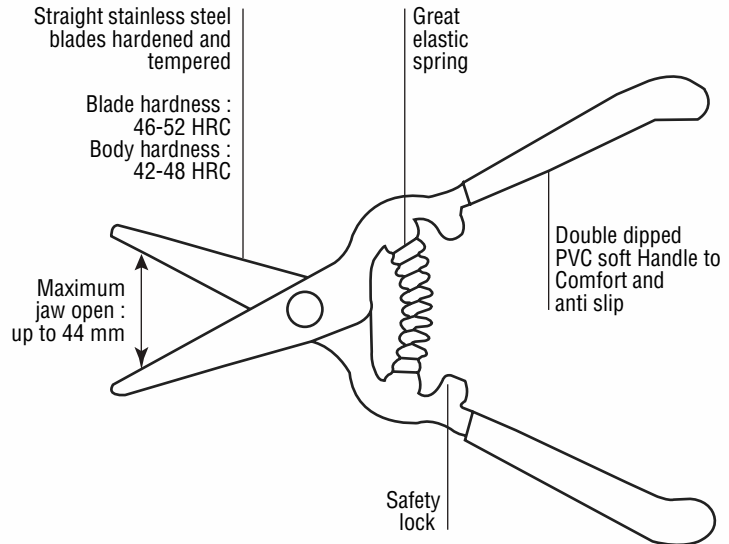

- Made of high-carbon stainless steel, corrosion-resistant
- Dentate slip design, sharp knife, better cutting effect
- The non-slip grip

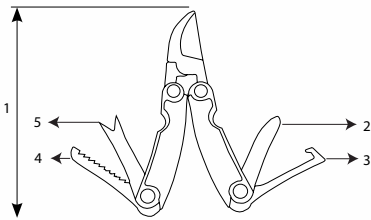

MULTIFUNCTION SCISSOR 6 IN 1

GUNTING MULTIFUNGSI 6 IN 1

ITEM CODE	SIZE	1 (mm)	2 (mm)	3 (mm)	4 (mm)	5 (mm)	WEIGHT (gr)	QTY / BOX INNER/MASTER
GT-MS1708	145 mm	145	56	55	57.4	56	201	6 / 72 pcs

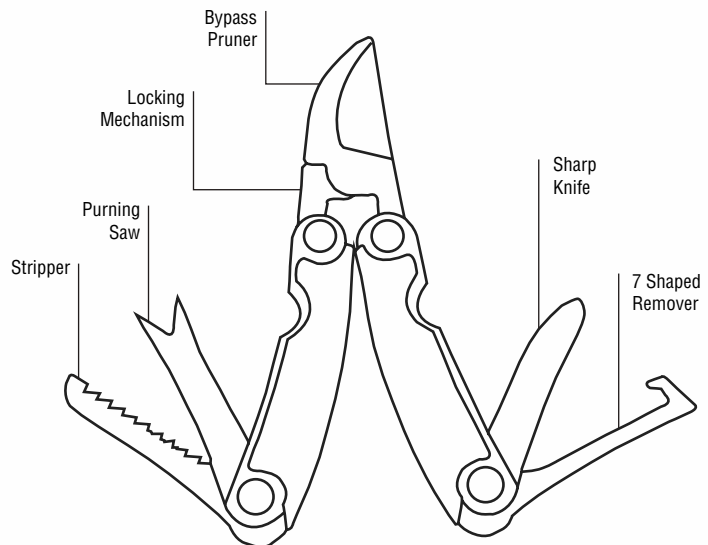



MEASUREMENT



TAPE MEASURE TRANSPARENT

Slim model with a high impact case made of ABS plastic. Yellow, wear resistant blade using painting coated, smooth blade return action and bump stop with anti-wear function

Superior internal mechanism provides smooth operation

Fast lock for quick and easy blade control



Hinge Rack for ease storage

High impact case made of ABS Plastic

With high accurate end-hook

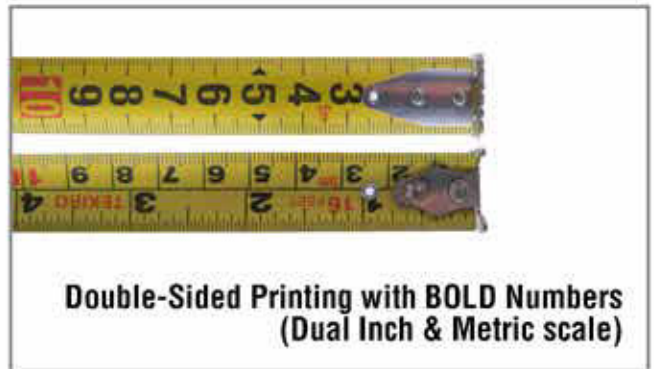

Double-Sided Printing with BOLD Numbers
(Dual Inch & Metric scale)

TAPE MEASURE 5 M FENG SHUI

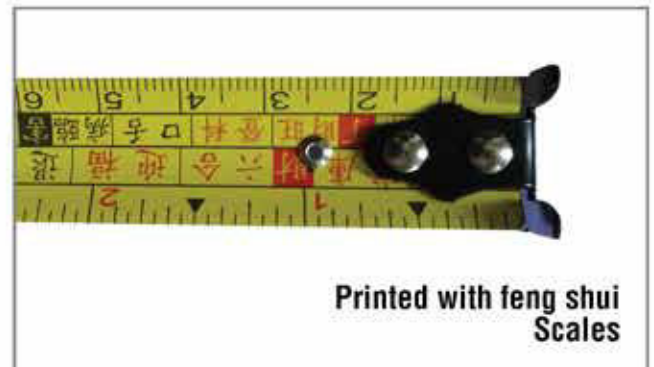

Printed with feng shui Scales

TAPE MEASURE TRANSPARENT

METERAN TRANSPARAN

ITEM CODE	SIZE	1 (mm)	2 (mm)	WEIGHT (gr)	QTY / BOX INNER/MASTER
GT-MT1718	3 m	61	29	141	12 / 120 pcs
GT-MT1719	5 m	70	32	238	12 / 60 pcs
GT-MT1720	7,5 m	80	38	408	6 / 60 pcs
GT-MT1721	10 m	85	39	531	6 / 60 pcs

- High impact ABS plastic
- Power-return tape for easy operation
- Dual-end hook holds blade firmly
- Dual inch/metric scale for any job
- Painting coated blade

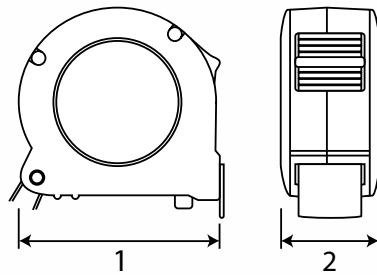

TAPE MEASURE 5 M FENG SHUI

METERAN FENG SHUI 5 M

ITEM CODE	SIZE	1 (mm)	2 (mm)	3 (mm)	WEIGHT (gr)	QTY / BOX INNER/MASTER
GT-MT1822	5 m	66	30	19	176	12 / 120 pcs

- High impact ABS plastic
- Power-return tape for easy operation
- Dual-end hook holds blade firmly
- Dual inch/metric scale for any job
- Painting coated blade

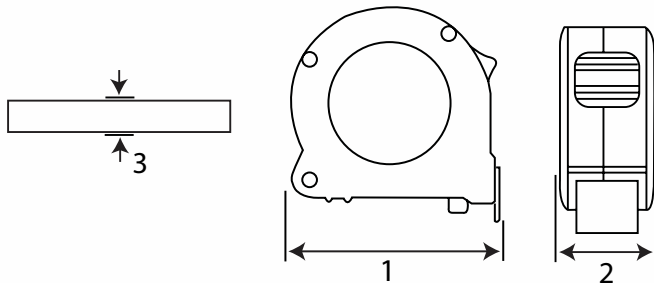

TESTING MANIFOLD

TESTING MANIFOLD REGULATOR FREON

ITEM CODE	SIZE	1 (mm)	2 (mm)	3 (mm)	4 (mm)	5 (mm)	6 (mm)	7 (mm)	8 (mm)	9 (mm)	WEIGHT (gr)	QTY / BOX INNER/MASTER
GT-TM1875	600 psi	73	73	11	11	11	175	17	17	17	1,562	1 / 16

- Solid Brass and seamless manifold body for R-12 & R-134a
- Blue Gauge (Low) : 0-350 Psi & Red Gauge (High) : 0-500 Psi
- 36" Hose, Working Pressure : 600 Psi and Burst Pressure : 3,000 Psi

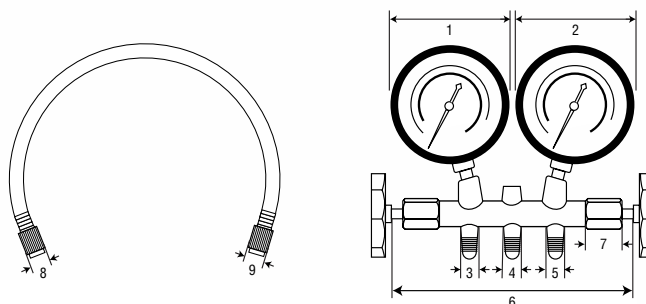

- CAT III, Overload Protection
- Low battery Indication
- Data Hold Function
- polarity Indication
- Auto Range
- Zeroing Function
- Automatic - Power Off



DIGITAL CLAMP METER

TANG AMPERE

ITEM CODE	MS-DC1905
DISPLAY	3 1/2 digit LCD, with a max. reading of 1999
OVER-RANGE INDICATION	OL shown on the display
NEGATIVE POLARITY INDICATION	Negative sign "-" shown on the display automatically
SAMPLING RATE	Approximate 3 times per sec
ERROR CAUSED BY IMPROPER POSITION	1% of reading
TJAW OPENING CAPACITY	25mm
MAX. MEASUREABLE CONDUCTOR	ø25mm
BATTERY	3V CR2032 button cells, 2 pieces
LOW BATTERY INDICATION	shown on the display
OPERATING ENVIRONMENT	Temperature: 0°C to 40°C
RELATIVE HUMIDITY	< 75%
STORAGE ENVIRONMENT	Temperature: -20°C to 50°C
RELATIVE HUMIDITY	< 85%RH
QTY / BOX (INNER / MASTER)	1 / 24
SIZE	190x76x36mm
WEIGHT	About 160g (including button cells)

- Troubleshoot Problems : Effectively capture voltage and frequency measurements and troubleshoot electrical problems
- Compact Size : Ideal for residential and automotive needs, the multimeter features a compact size that fits into your pocket or toolbelt for easy access.



COMPACT DIGITAL MULTIMETER

COMPACT DIGITAL MULTIMETER

ITEM CODE	MS-DM1906
DISPLAY	3 1/2 digit LCD, with a max. reading of 1999
NEGATIVE POLARITY INDICATION	Negative sign "-" shown on the display automatically
SAMPLING RATE	About 2 to 3 times/sec
OPERATING ENVIRONMENT	Temperature: 0°C to 50°C
RELATIVE HUMIDITY	< 75%
TEMPERATURE COEFFICIENT	0.2 x (specified accuracy)/°C (< 18°C or > 28°C)
STORAGE ENVIRONMENT	Temperature: -10°C to 60°C
RELATIVE HUMIDITY	< 85%RH
IP DEGREE	IP20
BATTERY	9V battery, 6F22 or equivalent, 1 piece
LOW BATTERY INDICATION	" " shown on the display
SIZE	144x80x38mm
QTY / BOX (INNER / MASTER)	1 / 54
WEIGHT (gr)	About 203g (including battery)

DIGITAL MULTIMETER

DIGITAL MULTIMETER

ITEM CODE	MS-DM1907
DISPLAY	3 1/2 digit LCD, with a max. reading of 1999
NEGATIVE POLARITY INDICATION	Negative sign "-" shown on the display automatically
SAMPLING RATE	About 2 to 3 times/sec
OPERATING ENVIRONMENT	Temperature: 0°C to 40°C
RELATIVE HUMIDITY	< 75%
TEMPERATURE COEFFICIENT	0.2 x (specified accuracy)/°C (< 18°C or > 28°C)
STORAGE ENVIRONMENT	Temperature: -10°C to 50°C
RELATIVE HUMIDITY	< 85%RH
OPERATING ALTITUDE	0 to 2000 meters
IP DEGREE	IP20
BATTERY	Vbattery, 6F22 or equivalent, 1 piece
LOW BATTERY INDICATION	" " shown on the display
SIZE	144x80x38mm
QTY / BOX (INNER / MASTER)	1 / 36
WEIGHT (gr)	About 214g (including battery)

- Squarewave output
- Data Hold
- polarity Indication
- Overrange Indication
- Overload protection
- Automatic - Power Off 15 min



TRUE RMS DIGITAL MULTIMETER

TRUE RMS DIGITAL MULTIMETER

ITEM CODE	MS-DM1908
FUSE PROTECTION FOR "INPUT" TERMINAL INPUTS	400mA/600V FAST fuse
FUSE PROTECTION FOR "10A" TERMINAL INPUTS	10A/600V FAST fuse
DISPLAY	3 3/4 digit LCD, with a max. reading of 3999
OVERRANGE INDICATION	OL shown on the display.
NEGATIVE POLARITY INDICATION	Negative sign "-" shown on the display automatically
SAMPLING RATE	About 2 to 3 times/sec
IP DEGREE	IP20
OPERATING ENVIRONMENT	Temperature: 0°C to 40°C
RELATIVE HUMIDITY	< 75%
TEMPERATURE COEFFICIENT	0.2 x (specified accuracy)/°C (< 18°C or > 28°C)
STORAGE ENVIRONMENT: TEMPERATURE	-10°C to 50°C
RELATIVE HUMIDITY	< 85%RH
OPERATING ALTITUDE	0 to 2000 meters
BATTERY	9V battery, 6F22 or equivalent, 1 piece
LOW BATTERY INDICATION	" " shown on the display
SIZE	185x89x61mm
QTY / BOX (INNER / MASTER)	1 / 20
WEIGHT	About 440g (including battery)

- TRUE RMS measurement for AC Voltage, AC Current Functions
- AUTORANGING : the meter defaults to autorange mode in measurement functions which have both autorange mode and manual range mode. when the meter in autorange mode, the symbol "AUTO" is displayed
- AUTO Power OFF: the display will blank and the meter will go sleep mode if you have not turned the function switch or pressed a button for about 15 minutes
- Built-in Non-Contact Voltage (NCV) Detector allows for quick detection of AC voltage



BELIEVE
IN YOUR CHOICE

WWW.TEKIRO.COM